



## GSSNA 300 schwarz/black

Industrial Connectors:Rectangular connectors GDM-series:Type CEN 175301-803 (DIN 43650):Appliance connector

### Product description

Description	appliance connector with central nut and 2 screws M 3 x 8
Type	GSSNA 300 schwarz/black
Order No.	933 111-100
Number of contacts	3 + PE
Standard	DIN EN 175 301-803-C
Housing Color	black
Construction type	C

### Drawing

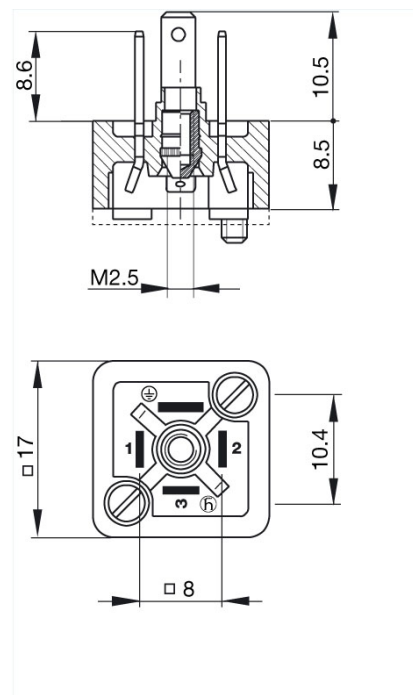

### Technical data

Rated voltage	AC/DC 250 V
Rated current	6 A
Contact resistance	$\leq 4$ mOhm
Type of termination	solder
Mounting	screw

### Material

Contact surface material	Sn
Contact bearer material	PA
Housing material	PA

### Environmental conditions

Protection class (IEC 60529)	IP 65
Pollution severity	3
Temperature range	-40 °C to +125 °C
<b>Inflammability class</b>	
Housing	94 HB
Contact bearer	94 V-2
<b>Approvals</b>	
UR	UR
VDE	VDE
SEV	SEV
CSA	CSA
<b>Packing unit</b>	
Packaging unit	200 pieces
<b>Scope of delivery and accessories</b>	
Accessories to order separately	(NBR) flat gasket GSSNA 300-5, Order No. 730 232-002; (EPDM) flat gasket GSSNA 300-6, Order No. 730 365-004