



WTB4S-3P2262V

W4S-3 Inox

PHOTOELECTRIC SENSORS

SICK
Sensor Intelligence.



Illustration may differ



Ordering information

| Type | Part no. |
|---------------|----------|
| WTB4S-3P2262V | 1046383 |

Other models and accessories → www.sick.com/W4S-3_Inox

Detailed technical data

Features

| | |
|--|--|
| Sensor/detection principle | Photoelectric proximity sensor, Background suppression |
| Dimensions (W x H x D) | 15.25 mm x 44.9 mm x 22.2 mm |
| Housing design | Washdown |
| Housing design (light emission) | Rectangular |
| Sensing range max. | 4 mm ... 500 mm ¹⁾ |
| Sensing range | 10 mm ... 350 mm ¹⁾ |
| Type of light | Visible red light |
| Light source | PinPoint LED ²⁾ |
| Light spot size (distance) | Ø 6.5 mm (150 mm) |
| Wave length | 650 nm |
| Adjustment | Single teach-in button |

¹⁾ Object with 90 % reflectance (referred to standard white, DIN 5033).

²⁾ Average service life: 100,000 h at T_U = +25 °C.

Mechanics/electronics

| | |
|---------------------------------------|---|
| Supply voltage | 10 V DC ... 30 V DC ¹⁾ |
| Ripple | < 5 V _{pp} ²⁾ |
| Power consumption | ≤ 30 mA ³⁾ |
| Output type | PNP |
| Output function | Complementary |
| Switching mode | Light/dark switching |
| Output current I_{max} | ≤ 100 mA |
| Response time | < 0.5 ms ⁴⁾ |
| Switching frequency | 1,000 Hz ⁵⁾ |
| Connection type | Connector M8, 4-pin ⁶⁾ |
| Circuit protection | A ⁷⁾ B ⁸⁾ C ⁹⁾ |
| Protection class | III |
| Weight | 40 g |
| Housing material | Stainless steel, stainless steel 316L |
| Enclosure rating | IP66, IP67, IP68, IP69K ¹⁰⁾ |
| Ambient operating temperature | -30 °C ... +70 °C ¹¹⁾ -30 °C ... +60 °C |
| Ambient storage temperature | -30 °C ... +75 °C |
| UL File No. | NRKH.E181493 & NRKH7.E181493 |

¹⁾ Limit values, reverse-polarity protected, operation in short-circuit protected network: max. 8 A.

²⁾ May not exceed or fall below U_v tolerances.

³⁾ Without load.

⁴⁾ Signal transit time with resistive load.

⁵⁾ With light/dark ratio 1:1.

⁶⁾ Max. tightening torque: 0.6 Nm.

⁷⁾ A = V_S connections reverse-polarity protected.

⁸⁾ B = inputs and output reverse-polarity protected.

⁹⁾ C = interference suppression.

¹⁰⁾ Only in case of correctly mounted IP69K connecting cable.

¹¹⁾ At UV ≤ 24 V and IA < 30 mA.

Classifications

| | |
|---------------------|----------|
| ECl@ss 5.0 | 27270904 |
| ECl@ss 5.1.4 | 27270904 |
| ECl@ss 6.0 | 27270904 |
| ECl@ss 6.2 | 27270904 |
| ECl@ss 7.0 | 27270904 |
| ECl@ss 8.0 | 27270904 |
| ECl@ss 8.1 | 27270904 |
| ECl@ss 9.0 | 27270904 |
| ETIM 5.0 | EC002719 |
| ETIM 6.0 | EC002719 |

UNSPSC 16.0901

39121528

Connection diagram

Cd-083

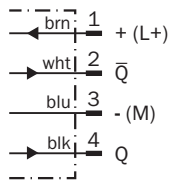

Characteristic curve

WTB4S-3, 500 mm

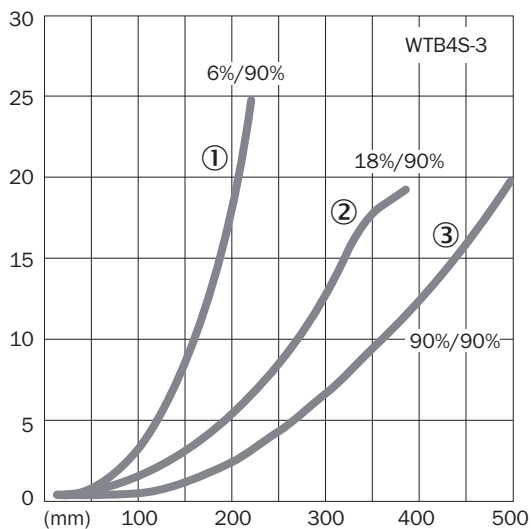

- ① Sensing range on black, 6% remission
- ② Sensing range on gray, 18 % remission
- ③ Sensing range on white, 90% remission

Sensing range diagram

WTB4S-3, 500 mm

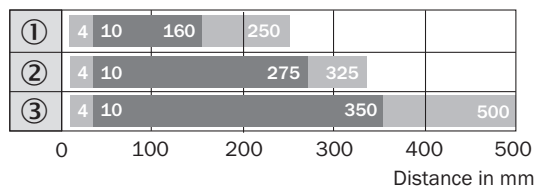

■ Sensing range ■ Sensing range max.

- ① Sensing range on black, 6% remission
- ② Sensing range on gray, 18 % remission
- ③ Sensing range on white, 90% remission

Dimensional drawing (Dimensions in mm (inch))

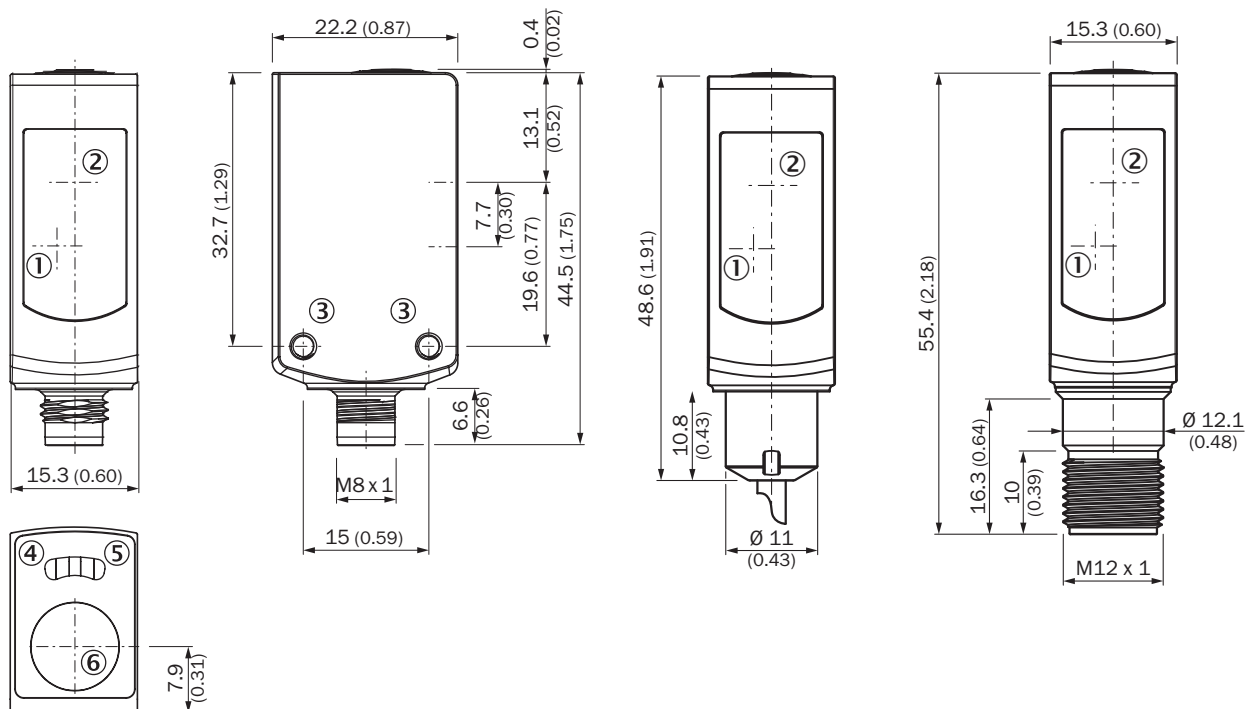

WTB4S-3V, WTF4S-3V, Single teach-in button



- ① Center of optical axis, receiver
- ② Center of optical axis, sender
- ③ Threaded mounting hole M3
- ④ LED indicator yellow: Status of received light beam
- ⑤ LED indicator green: Supply voltage active
- ⑥ Teach-in button

Recommended accessories

Other models and accessories → www.sick.com/W4S-3_Inox

| | Brief description | Type | Part no. |
|---|--|--------------|----------|
| Universal bar clamp systems | | | |
|  | Plate N02N for universal clamp bracket, Stainless steel 1.4571 (sheet), Stainless steel 1.4408 (clamp), Universal clamp (5322626), mounting hardware | BEF-KHS-N02N | 2051618 |
| Plug connectors and cables | | | |
|  | Head A: female connector, M8, 4-pin, straight Head B: - Cable: unshielded | DOS-0804-G | 6009974 |
|  | Head A: male connector, M8, 4-pin, straight Head B: - Cable: unshielded | STE-0804-G | 6037323 |

SICK AT A GLANCE

SICK is one of the leading manufacturers of intelligent sensors and sensor solutions for industrial applications. A unique range of products and services creates the perfect basis for controlling processes securely and efficiently, protecting individuals from accidents and preventing damage to the environment.

We have extensive experience in a wide range of industries and understand their processes and requirements. With intelligent sensors, we can deliver exactly what our customers need. In application centers in Europe, Asia and North America, system solutions are tested and optimized in accordance with customer specifications. All this makes us a reliable supplier and development partner.

Comprehensive services complete our offering: SICK LifeTime Services provide support throughout the machine life cycle and ensure safety and productivity.

For us, that is “Sensor Intelligence.”

WORLDWIDE PRESENCE:

Contacts and other locations –www.sick.com