

# SMA 50 Ohm Right Angle Bulkhead Jack Receptacle

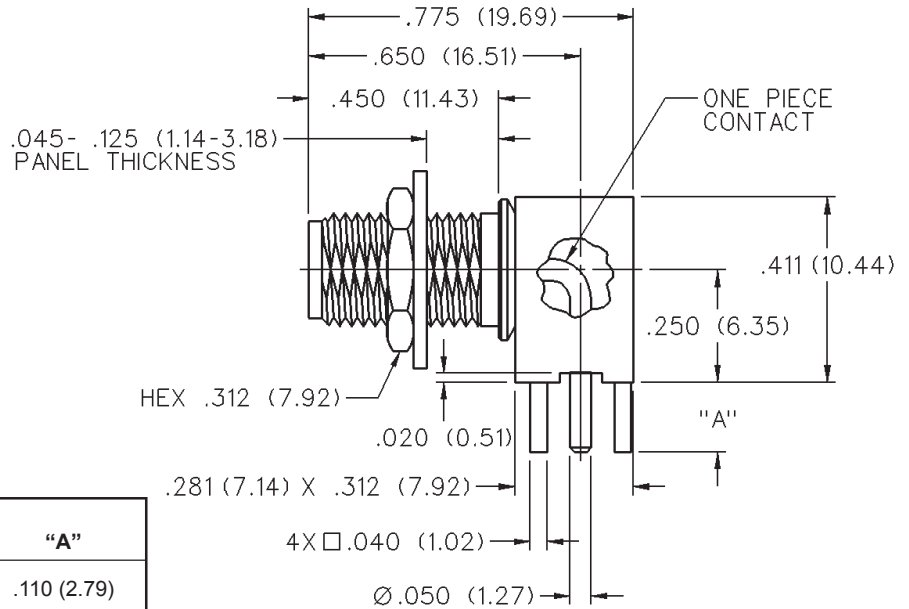

VSWR & FREQ. RANGE	GOLD PLATED	NICKEL PLATED	"A"
VSWR: N/A 0-18 GHz	142-0701-551	142-0701-556	.110 (2.79)

Mounting hole layouts

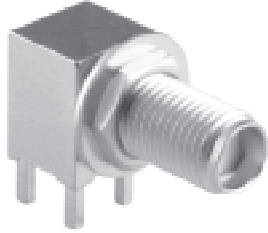