

Subminiature Fuse, 8.5 mm, Quick-Acting F, 250 VAC



IEC 60127-3 · 250 VAC · Quick-Acting F



### Description

- Directly solderable on printed circuit boards
- Low Breaking Capacity

### Standards

- IEC 60127-3/3
- UL 248-14
- CSA C22.2 no. 248.14

### Approvals

- Approval Reference Type: MSF 250
- VDE Certificate Number: 101035
- UL File Number: E41599
- CSA File Number: 51172

### References

- [Packaging Details](#)
- Corresponding Fuseholder [FMS \(250V\)](#)
- Fuse Kit [Fuse Kit MST250 / MSF 250](#)

### Weblinks

- [pdf datasheet](#), [html-datasheet](#), [General Product Information](#), [Packaging details](#), [Approvals](#), [CE declaration of conformity](#), [RoHS](#), [CHINA-RoHS](#), [REACH](#), [Distributor-Stock-Check](#), [Detailed request for product](#)

### Technical Data

Rated Voltage	250 VAC
Rated current	0.04 - 5 A
Breaking Capacity	35 A
Characteristic	Quick-Acting F
Mounting	PCB, THT
Admissible Ambient Air Temp.	-40 °C to 85 °C
Climatic Category	40/085/21 acc. to IEC 60068-1
Material: Housing	Thermoplastic, UL 94V-0
Material: Terminals	Tin-Plated Copper
Unit Weight	0.5 g
Storage Conditions	0 °C to 40 °C, max. 70% r.h.
Product Marking	 Type, Rated current, Rated Voltage, Characteristic, Approvals

Soldering Methods	Wave, Iron <a href="#">Soldering Profile</a>
Solderability	235 °C / 2 sec acc. to IEC 60068-2-20, Test Ta
Resistance to Soldering Heat	260 °C / 10 sec acc. to IEC 60068-2-20, Test Tb
Resistance to Vibration	acc. to IEC 60068-2-6, test Fc
Current Carrying Capacity	acc. to EIA/IS-722, Test 4.3.3
Life Test	1000h @ 0.60 x In @ 70°C (acc. to EIA/IS-722, Test 4.4.1)
Load Humidity Test	0.1 x In @ 0.85 r.H. @ 85°C (acc. to EIA/IS-722, Test 4.4.2)
Moisture Resistance Test	(acc. to EIA/IS-722, Test 4.4.3)
Terminal Strength	Tensile load min. 9 N (acc. to EIA/IS-722, Test 4.5.1)
Thermal Shock	MIL-STD-202, Method 107D (200 air-to-air cycles from -55 to +125°C)
Case Resistance	>100 MΩ (between leads and body) acc. to EIA/IS-722, Test 4.7
Mechanical Shock	MIL-STD-202, Method 213B (Shock 50g, half sine wave, 11 ms)
Resistance to Solvents	MIL-STD-202, Method 215A
Flammability	UL 94V-0 (acc. to EIA/IS-722, Test 4.12)

Detailed information on product approvals, code requirements, usage instructions and detailed test conditions can be looked up in [General Product Information](#)

Dimension

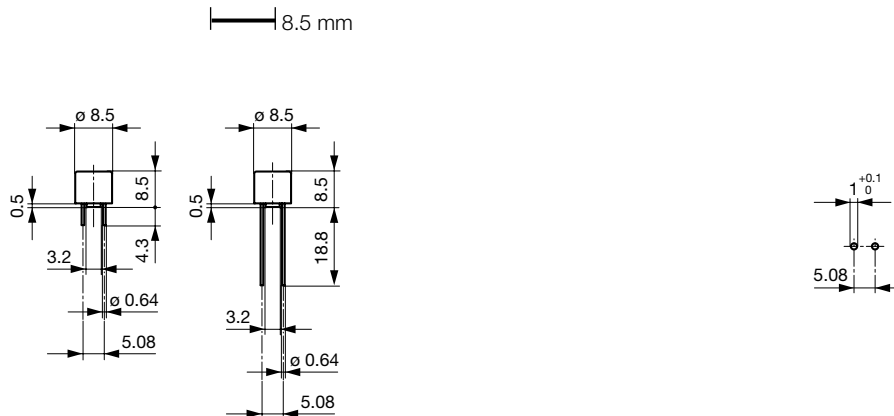

Drilling diagram

Pre-Arcing Time

Rated Current In 1.5 x In min. 2.1 x In max. 2.75 x In min. 2.75 x In max. 4.0 x In min. 4.0 x In max. 10.0 x In max.



0.04 A - 5 A	60 min	30 min	10 ms	3 s	3 ms	300 ms	20 ms
--------------	--------	--------	-------	-----	------	--------	-------

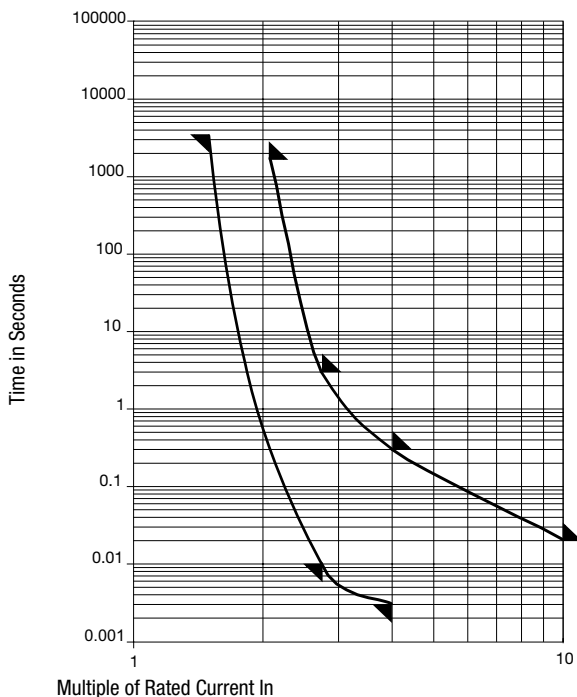

Time-Current-Curves



All Variants

Rated Current [A]	Rated Voltage [VAC]	Breaking Capacity	Voltage Drop 1.0 In max. [mV]	Voltage Drop 1.0 In typ. [mV]	Power Dissipation 1.5 In max. [mW]	Melting I²t 10.0 In typ. [A²s]		S	L	T	Order Number
0.04	250	1)	-	400	-	0.00016	●	●			0034.6000
0.05	250	1)	850	460	110	0.0004	●	●	●	●	0034.6001
0.063	250	1)	750	330	120	0.001	●	●	●	●	0034.6002
0.08	250	1)	650	280	140	0.001	●	●	●	●	0034.6003
0.1	250	1)	600	300	160	0.002	●	●	●	●	0034.6004
0.125	250	1)	550	210	180	0.006	●	●	●	●	0034.6005

Rated Current [A]	Rated Voltage [VAC]	Breaking Capacity	Voltage Drop 1.0 I <sub>n</sub> max. [mV]	Voltage Drop 1.0 I <sub>n</sub> typ. [mV]	Power Dissipation 1.5 I <sub>n</sub> max. [mW]	Melting I <sup>2</sup> t 10.0 Intyp. [A <sup>2</sup> s]				S	L	T	Order Number
0.16	250	1)	500	460	210	0.014	●	●	●	●			0034.6006
0.2	250	1)	480	470	250	0.024	●	●	●	●			0034.6007
0.25	250	1)	440	360	290	0.058	●	●	●	●			0034.6008
0.315	250	1)	400	345	330	0.104	●	●	●	●			0034.6009
0.4	250	1)	370	80	390	0.044	●	●	●	●			0034.6010
0.5	250	1)	350	75	460	0.09	●	●	●	●			0034.6011
0.63	250	1)	320	70	530	0.15	●	●	●	●			0034.6012
0.8	250	1)	300	70	630	0.22	●	●	●	●			0034.6013
1	250	1)	280	70	740	0.33	●	●	●	●			0034.6014
1.25	250	1)	280	65	920	0.68	●	●	●	●			0034.6015
1.6	250	1)	250	70	1000	0.94	●	●	●	●			0034.6016
2	250	1)	240	70	1360	1.3	●	●	●	●			0034.6017
2.5	250	1)	200	65	1310	1.9	●	●	●	●			0034.6018
3.15	250	1)	180	65	1490	5.4	●	●	●	●			0034.6019
4	250	2)	160	60	1680	7.9	●	●	●	●			0034.6020
5	250	2)	150	60	1970	11.2	●	●	●	●			0034.6021
0.04	250	1)	-	400	-	0.00016	●	●	●	●			0034.6030
0.05	250	1)	850	460	110	0.0004	●	●	●	●			0034.6031
0.063	250	1)	750	330	120	0.001	●	●	●	●			0034.6032
0.08	250	1)	650	280	140	0.001	●	●	●	●			0034.6033
0.1	250	1)	600	300	160	0.002	●	●	●	●			0034.6034
0.125	250	1)	550	210	180	0.006	●	●	●	●			0034.6035
0.16	250	1)	500	460	210	0.014	●	●	●	●			0034.6036
0.2	250	1)	480	470	250	0.024	●	●	●	●			0034.6037
0.25	250	1)	440	360	290	0.058	●	●	●	●			0034.6038
0.315	250	1)	400	345	330	0.104	●	●	●	●			0034.6039
0.4	250	1)	370	80	390	0.044	●	●	●	●			0034.6040
0.5	250	1)	350	75	460	0.09	●	●	●	●			0034.6041
0.63	250	1)	320	70	530	0.15	●	●	●	●			0034.6042
0.8	250	1)	300	70	630	0.22	●	●	●	●			0034.6043
1	250	1)	280	70	740	0.33	●	●	●	●			0034.6044
1.25	250	1)	280	65	920	0.68	●	●	●	●			0034.6045
1.6	250	1)	250	70	1000	0.94	●	●	●	●			0034.6046
2	250	1)	240	70	1360	1.3	●	●	●	●			0034.6047
2.5	250	1)	200	65	1310	1.9	●	●	●	●			0034.6048
3.15	250	1)	180	65	1490	5.4	●	●	●	●			0034.6049
4	250	2)	160	60	1680	7.9	●	●	●	●			0034.6050
5	250	2)	150	60	1970	11.2	●	●	●	●			0034.6051
0.04	250	1)	-	400	-	0.00016	●	●	●	●			0034.6060
0.05	250	1)	850	460	110	0.0004	●	●	●	●			0034.6061
0.063	250	1)	750	330	120	0.001	●	●	●	●			0034.6062
0.08	250	1)	650	280	140	0.001	●	●	●	●			0034.6063
0.1	250	1)	600	300	160	0.002	●	●	●	●			0034.6064
0.125	250	1)	550	210	180	0.006	●	●	●	●			0034.6065
0.16	250	1)	500	460	210	0.014	●	●	●	●			0034.6066
0.2	250	1)	480	470	250	0.024	●	●	●	●			0034.6067
0.25	250	1)	440	360	290	0.058	●	●	●	●			0034.6068
0.315	250	1)	400	345	330	0.104	●	●	●	●			0034.6069
0.4	250	1)	370	80	390	0.044	●	●	●	●			0034.6070
0.63	250	1)	320	70	530	0.15	●	●	●	●			0034.6072
0.8	250	1)	300	70	630	0.22	●	●	●	●			0034.6073
1	250	1)	280	70	740	0.33	●	●	●	●			0034.6074
1.25	250	1)	280	65	920	0.68	●	●	●	●			0034.6075

Rated Current [A]	Rated Voltage [VAC]	Breaking Capacity	Voltage Drop 1.0 In max. [mV]	Voltage Drop 1.0 In typ. [mV]	Power Dissipation 1.5 I <sub>n</sub> max. [mW]	Melting I <sup>2</sup> t 10.0 Intyp. [A <sup>2</sup> s]				S	L	T	Order Number
1.6	250	1)	250	70	1000	0.94	●	●	●	●			0034.6076
2	250	1)	240	70	1360	1.3	●	●	●	●			0034.6077
2.5	250	1)	200	65	1310	1.9	●	●	●	●			0034.6078
3.15	250	1)	180	65	1490	5.4	●	●	●	●			0034.6079
4	250	2)	160	60	1680	7.9		●					0034.6080
5	250	2)	150	60	1970	11.2		●					0034.6081

Most Popular.

Availability for all products can be searched real-time: <http://www.schurter.com/en/Stock-Check/Stock-Check-SCHURTER>

1) 35 A @ 250 VAC

2) 10 In @ 250 VAC

Packaging Unit	S = 4.3 mm	Plastic Bag (100 pcs.)
	L = 18.8 mm	Bulk (100 pcs.)
	T = 18.8 mm	Taped 36 cm Reel (750 pcs.)