

Print and SMD Switch Short Stroke 11.4 mm



SMS with Gullwing lead, IP40



SMS with adapter and elongated button, J-lead



Description

- Switches are possible with different heights
- High-quality gold and silver contacts
- Solder terminals

Unique Selling Proposition

- Reliable tactile feedback on input
- Simple assembly
- Long life time

Weblinks

[html-datasheet](#), [General Product Information](#), [CE declaration of conformity](#), [RoHS](#), [CHINA-RoHS](#), [CAD-Drawings](#), [Product News](#), [Detailed request for product](#)

Technical Data

Electrical Data

Switching Voltage	30 VAC/ 42 VDC
Switching Current	50 mA
Rated Switching Capacity	0.12 W
Lifetime	> 1 million actuations at Rated Switching Capacity
Contact Resistance	< 50mΩ < 150 mΩ after lifetime
Insulation Resistance	> 100 MΩ
Duration of Bounce	typ. 0.15 ms

Mechanical Data

Actuating Force	IP 40: 1.8 ± 0.4 N IP 67: 2.2 ± 0.4 N
Actuating Travel	0.35 ± 0.1 mm
End Stop Strength	< 100 N
Lifetime	> 1 million actuations

Climatical Data

Operating Temperature	-40°C to 85°C
Storage Temperature	-40°C to 85°C
IP-Protection	IP 40 and IP 67

Soldering Data

Soldering Methods	Reflow
Solderability	245 °C / 5 sec (IEC 60068-2-58 Test Td)
Resistance to Soldering Heat	260 °C / 10 sec (IEC 60068-2-58 Test Td)

Material

Sealing membrane IP 67	VMQ
Contact Material Gold	CuZn37 1.5 µm Ni 0.5 µm Au
Terminals	CuZn37 8 µm SnPb
Socket	Thermoplastic (PA 4.6)
Actuator	Thermoplastic (PPS)
Cover of Actuator	X 12 CrNi 17 7
Elongated Button	Thermoplastic (PC)

Detailed information on product approvals, code requirements, usage instructions and detailed test conditions can be looked up in [General Product Information](#)

Dimension

SMS Gullwing Base module

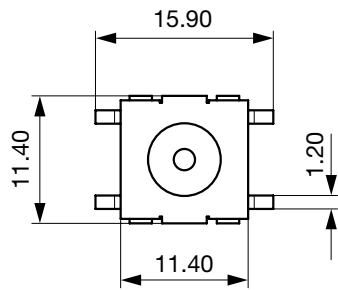
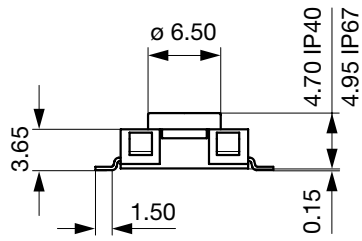

SMS J-lead Base module

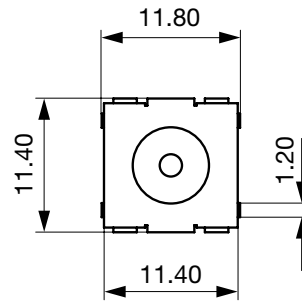
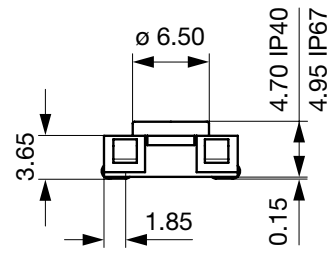

SMS Gullwing Variable height

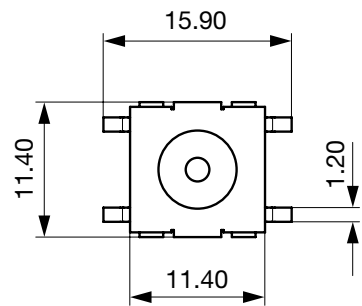
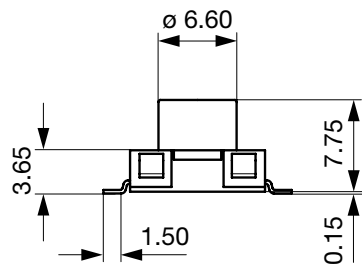

SMS J-lead Variable height

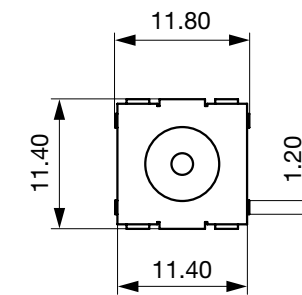
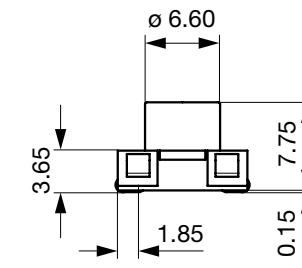

PCP Lead

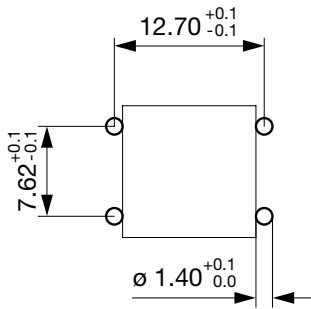

Gullwing Lead

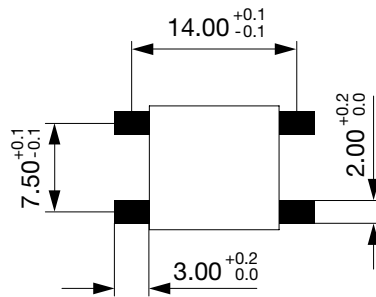

J-Lead

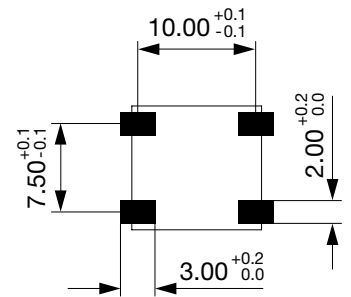

SMS Gullwing with elongated button SMS J lead with elongated button

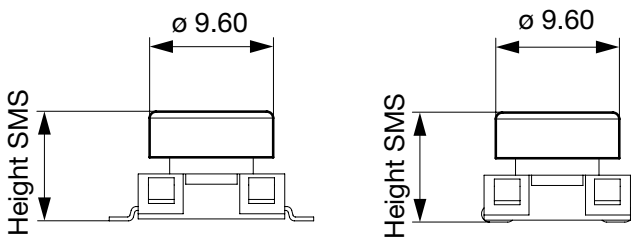

Diagrams

Circuit Diagram SMS/PMS

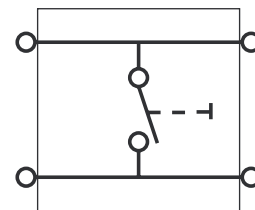
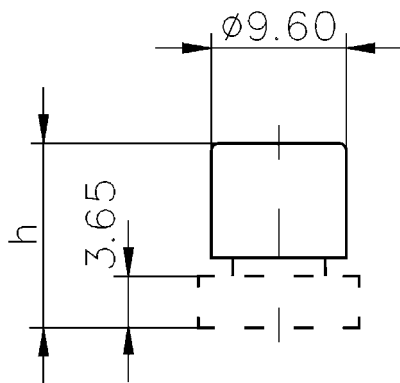

All Variants

IP Protection Class Front Side	Terminal	Type	Overall height / Color	Order Number
-	-	Second elongated button	-	0862.8226
IP 40	Gullwing	Short actuator	-	1241.1600.11
IP 40	Gullwing	Short actuator	-	1241.1600.23
IP 40	Gullwing	Long actuator	-	1241.1612.11
IP 40	Gullwing	Long actuator	-	1241.1612.23

IP Protection Class Front Side	Terminal	Type	Overall height / Color	Order Number
IP 40	J-Lead	Short actuator	-	1241.1601.11
IP 40	J-Lead	Short actuator	-	1241.1601.23
IP 40	J-Lead	Long actuator	-	1241.1613.11
IP 40	J-Lead	Long actuator	-	1241.1613.13
IP 67	Gullwing	Short actuator	-	1241.1606.11
IP 67	Gullwing	Short actuator	-	1241.1606.23
IP 67	Gullwing	Long actuator	-	1241.1618.11
IP 67	Gullwing	Long actuator	-	1241.1618.23
IP 67	J-Lead	Short actuator	-	1241.1607.11
IP 67	J-Lead	Short actuator	-	1241.1607.23
IP 67	J-Lead	Long actuator	-	1241.1619.11
IP 67	J-Lead	Long actuator	-	1241.1619.23
-	-	Elongated button	8.50 mm / yellow	0862.8101
-	-	Elongated button	9.25 mm / orange	0862.8102
-	-	Elongated button	10.00 mm / red	0862.8103
-	-	Elongated button	10.75 mm / blue	0862.8104
-	-	Elongated button	11.50 mm / green	0862.8105
-	-	Elongated button	12.25 mm /grey	0862.8106
-	-	Elongated button	13.00 mm / black	0862.8107
-	-	Elongated button	13.75 mm / white	0862.8108

Availability for all products can be searched real-time:<http://www.schurter.com/en/Stock-Check/Stock-Check-SCHURTER>

Additional elongated button for long actuators must be ordered separately

From 14:50 mm an additional (second) elongated button for intermediate sizes (h + 6 mm) is required. This must be ordered separately

Packaging unit	
.xx = .11	loose in boxes (100 pcs.)
.xx = .23	Blister Tape 33 cm Reel for short actuator (700 pcs.)
.xx = .23	Blister Tape 33 cm Reel for long actuator (450 pcs.)