

Total solder points: 92

Difficulty level: *beginner* 1 2 3 4 5 *advanced*

RELAY CARD

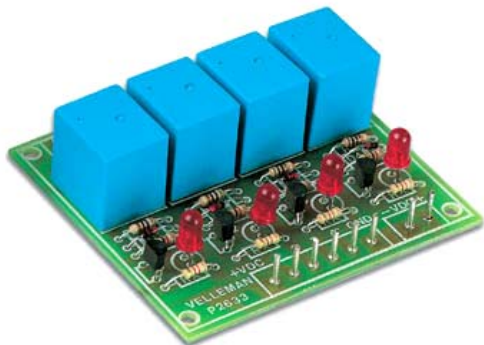

K2633

*“Control up to 4 high-power circuits
from a low-power drive circuit.”*

The connection of a few relays to the outputs of an electronic circuit might be theoretically very simple, but practically it may lead to a very complicated matter with all possible results. This kit is an attractive and compact alternative, fast to construct and to mount. It can be used with open collector circuits.

Features:

- Four relay outputs, single pole invertors
- Max. load : 240V AC / 3A resistive
- 9V DC / 300 mA power supply
- Four control-LED's are provided
- Is controlled by an open collector output (9V/15 mA)
- Dimensions : 76 x 69 x 25 mm.

1. Assembly (Skipping this can lead to troubles !)

Ok, so we have your attention. These hints will help you to make this project successful. Read them carefully.

1.1 Make sure you have the right tools:

- A good quality soldering iron (25-40W) with a small tip.
- Wipe it often on a wet sponge or cloth, to keep it clean; then apply solder to the tip, to give it a wet look. This is called 'thinning' and will protect the tip, and enables you to make good connections. When solder rolls off the tip, it needs cleaning.
- Thin raisin-core solder. Do not use any flux or grease.
- A diagonal cutter to trim excess wires. To avoid injury when cutting excess leads, hold the lead so they cannot fly towards the eyes.
- Needle nose pliers, for bending leads, or to hold components in place.
- Small blade and Phillips screwdrivers. A basic range is fine.

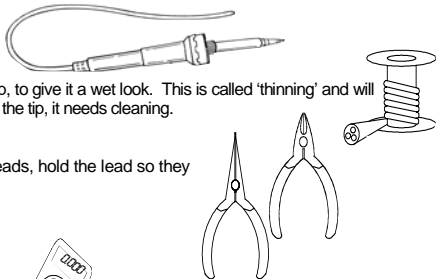

For some projects, a basic multi-meter is required, or might be handy

1.2 Assembly Hints :

- ⇒ Make sure the skill level matches your experience, to avoid disappointments.
 - ⇒ Follow the instructions carefully. Read and understand the entire step before you perform each operation.
 - ⇒ Perform the assembly in the correct order as stated in this manual
 - ⇒ Position all parts on the PCB (Printed Circuit Board) as shown on the drawings.
 - ⇒ Values on the circuit diagram are subject to changes.
 - ⇒ Values in this assembly guide are correct*
 - ⇒ Use the check-boxes to mark your progress.
 - ⇒ Please read the included information on safety and customer service
- * Typographical inaccuracies excluded. Always look for possible last minute manual updates, indicated as 'NOTE' on a separate leaflet.

1.3 Soldering Hints :

1- Mount the component against the PCB surface and carefully solder the leads

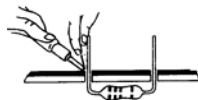

2- Make sure the solder joints are cone-shaped and shiny

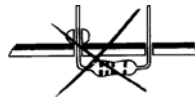
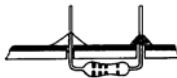

3- Trim excess leads as close as possible to the solder joint

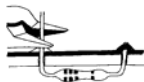

REMOVE THEM FROM THE TAPE ONE AT A TIME !

AXIAL COMPONENTS ARE TAPED IN THE CORRECT MOUNTING SEQUENCE !

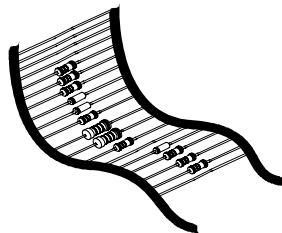

1. Diodes. Watch the polarity !

- D1 : 1N4148
- D2 : 1N4148
- D3 : 1N4148
- D4 : 1N4148

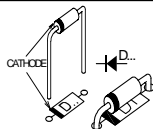

2. Resistors

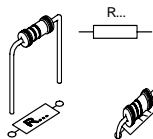

- R1 : 56 (5 - 6 - 0 - B - 9)
- R2 : 56 (5 - 6 - 0 - B - 9)
- R3 : 56 (5 - 6 - 0 - B - 9)
- R4 : 56 (5 - 6 - 0 - B - 9)

- R5 : 820 (8 - 2 - 1 - B)
- R6 : 820 (8 - 2 - 1 - B)
- R7 : 820 (8 - 2 - 1 - B)
- R8 : 820 (8 - 2 - 1 - B)
- RX : 820 (8 - 2 - 1 - B) (4x)

3. Transistors.

- T1 : BC557B
- T2 : BC557B
- T3 : BC557B
- T4 : BC557B

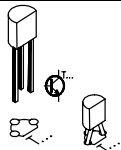

4. LEDs. Watch the polarity!

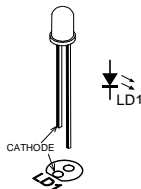

- LD1 : 5mm RED
- LD2 : 5mm RED
- LD3 : 5mm RED
- LD4 : 5mm RED



5. PCB tabs.

- NC (4x)
- NO (4x)
- C (4x)
- + VDC (2x)
- VDC
- 1
- 2
- 3
- 4
- GND

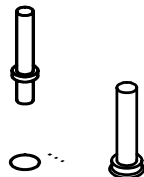

6. Relays

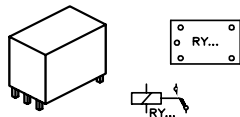

- RY1
- RY2
- RY3
- RY4

7. Connection

Connect the power voltage of the relay to the 9V DC points.

☞ This voltage needs not to be stabilised.

The connection of the loads to the relays is very simple : at the outputs the name of the contact is given.

- C stands for the common contact.
- NC for the contact of the inverter that is closed in rest.
- NO for the normal open contact.

In most cases you will only use C and NO.

☞ In order to avoid disturbances and bum-in of the contacts when switching inductive loads (motors, heavy-duty-relays, ...) we recommend to install a VDR over the contacts.

When this should not be an adequate cure against disturbances in the control circuit, you have to place the relay print nearby the load itself.

8. PCB layout.

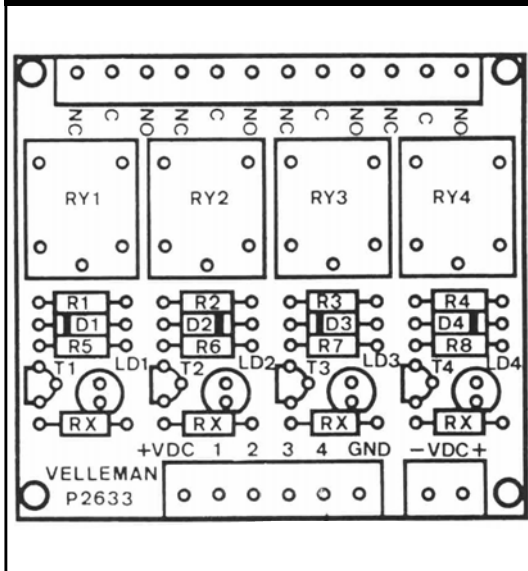

9. Diagram

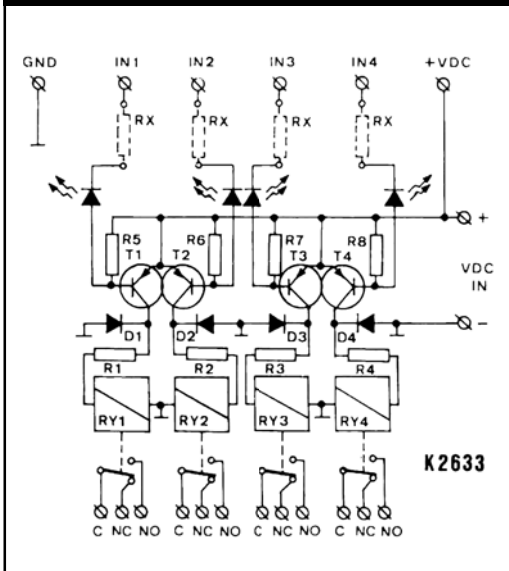



Modifications and typographical errors reserved

© Velleman Components nv.

H2633IP - 2004 - ED1 (rev.1.0)

