

IP camera tester

User Manual

(IPC1.03)



- Thank you for purchasing the IP camera tester. Please read the manual before using the IP camera tester and use properly.
- For using the IP camera tester safely, please first read the 「Safety Information」 carefully in the manual.
- The manual should be kept well in case of reference.
- Keep the S/N label for after-sale service within warranty period. Product without S/N label will be charged for repair service.
- If there is any question or problem while using the IP camera tester, or damages occurred on the product, please contact our technical Department.

Content

1 Safety information	3
2 IP Camera Tester Introduction	4
2.1 General	4
2.2 Features	4
2.3 Function	7
2.4 Packing list	14
2.5 Function interface	15
3. Operation	19
3.1 Installing the Battery	19
3.2 Instrument connection	20
3.2.1 IP camera connection	20
3.2.2 Analog camera connection	21
3.2.3 HD Coaxial camera connection	22
3.3 OSD menu	23
3.3.1 Video monitor test (PTZ control)	25
3.3.2 Color-bar generator (TV OUT)	35
3.3.3 ONVIF	35
3.3.4 IP camera test	44
3.3.5 SDI camera test (* Optional)	47
3.3.6 CVI camera test (* Optional)	49
3.3.7 TVI camera test (* Optional)	53
3.3.8 AHD camera test (* Optional)	55
3.3.9 IP address scan	56
3.3.10 PING Test	57
3.3.11 Cable test	58
3.3.12 Cable tracer (* Optional)	58

3.3.13 Port finder	60
3.3.14 Data monitor	61
3.3.15 Optical power meter (* Optional)	61
3.3.16 Visual Fault Locator (* Optional)	63
3.3.17 Digital Multi-meter (* Optional)	64
3.3.18 Media Player	70
3.3.19 Audio player	71
3.3.20 LED Flashlight	72
3.3.21 PoE/PSE Voltage test	72
3.3.22 TDR cable test (* Optional)	73
3.3.23 Calculator	76
3.3.24 Browser	76
3.3.25 IP camera viewer	77
3.3.26 PoE power / DC12V 2A and DC 5V 2A USB power output	78
3.3.27 Application tools	80
3.3.28 APPS Tools Folder	88
3.3.29 System Setting	89
3.3.30 Update	92
3.4 HDMI output	92
3.5 PoE power output	92
3.6 DC12V 2A power output	93
3.7 USB 5V 2A power output	94
3.8 Audio test	95
4. Specifications	96
4.1 General Specifications	96
4.2 Multi-meter specifications	98
4.3 Optical power meter specifications	100
4.4 Visual fault locator specifications	101

1 Safety information

The tester is intended to use in compliance with the local rules of the electrical usage and avoid to apply at the places which are inapplicable for the use of electrics such as hospital, gas station etc.

- ◆ To prevent the functional decline or failure, the product should not be sprinkled or damped.
- ◆ The exposed part of the tester should not be touched by the dust and liquid.
- ◆ During transportation and use, it is highly recommended to avoid the violent collision and vibration of the tester, lest damaging components and causing failure.
- ◆ Don't leave the tester alone while charging and recharging. If the battery is found severely hot, the tester should be powered off from the electric source at once. The tester should not be charged over 8 hours.
- ◆ Don't use the tester where the humidity is high. Once the tester is damp, power off immediately and move away other connected cables.
- ◆ The tester should not be used in the environment with the flammable gas.
- ◆ Do not disassemble the instrument since no component inside can be repaired by the user. If the disassembly is necessary indeed, please contact with the technician of our company.
- ◆ The instrument should not be used under the environment with strong electromagnetic interference.
- ◆ Don't touch the tester with wet hands or waterish things.
- ◆ Don't use the detergent to clean and the dry cloth is suggested to use. If the dirt is not easy to remove, the soft cloth with water or neutral detergent can be used. But the cloth should be tweaked sufficiently.

About Digital Multi-meter

- ◆ Before using, you must select the right input jack, function and range.
 - ◆ Never exceed the protection limit values indicated in specifications for each range of measurement.
- ◆ When the tester is linked to a measurement circuit, do not touch unused terminals.
- ◆ Do not measure voltage if the voltage on the terminals exceeds 660V above earth ground.
- ◆ At the manual range, when the value scale to be measured is unknown beforehand, set the range selector at the highest position.
- ◆ Always be careful when working with voltages above 60V DC or 40V AC, keep fingers behind the probe barriers while measuring.

- ◆ Never connect the meter with any voltage source while the function switch is in the current, resistance, capacitance, diode, continuity, otherwise it will damage the meter.
- ◆ Never perform capacitance measurements unless the capacitor to be measured has been discharged fully.
- ◆ Never measure any of resistance, capacitance, diode or continuity measurements on live circuits.

Visual laser sources

When you turn on visual laser sources, please don't stare at it, or will damage to eyes

When not using it, please turn it off and cover the protective cap

2 IP Camera Tester Introduction

2.1 General

The 4.3 inch touch screen IP camera monitor and tester is designed for maintenance and installation of IP camera and analog camera as well as other security equipments , 800x480 resolution enables it to display network HD cameras and analog cameras in high resolution. The unit supports many ONVIF PTZ and analog PTZ control. The combination of touch screen and key buttons make the IP camera tester very user- friendly.

The tester is also a great tool for Ethernet network testing. It can test PoE power voltage, PING, and IP address searching. You can use the blue cable tracer to locate individual connected cables from a bundle of cables. Test LAN cable for proper connection termination. Other functions include providing 24W PoE power to your camera, LED Flashlight, DC 12V 2A power output and much more. Its portability, user-friendly design and many other functions make the IP tester an essential tool for all installers or technicians.

2.2 Features

- ◇ 4.3inch 800×480 touch screen, easy to operate.
- ◇ ONVIF IP camera video testing
- ◇ Compatible with H.264/MPEG4/MJPEG IP cameras, such as Dahua, HIKVISION, and ACTI

Customized service is available.

- ✧ Built in Wi-Fi ,can receive image from wireless camera, as well as ONVIF and customized IP cameras.
- ✧ SDI Digital camera image display, record and screen snapshot (***Optional**)
- ✧ HD CVI camera image display, zoom ,video record and playback ,coaxial PTZ control and call camera OSD menu (***Optional**)
- ✧ HD TVI camera image display, zoom ,video record and playback ,coaxial PTZ control and call camera OSD menu (***Optional**)
- ✧ AHD camera image display, zoom ,video record and playback ,coaxial PTZ control and call camera OSD menu (***Optional**)
- ✧ HDMI signal output, support 1080P
- ✧ Analog camera image display, Auto adapt and display the video format of NTSC/PAL
- ✧ Support more than 30 protocols ,such as PELCO-P,PELCO-D,SAMSUNG etc
- ✧ PEAK video signal level, SYNC signal level, Color burst chroma level measurement,test video signal attenuation (***Optional**)
- ✧ Video image digital zoom to view the image in greater detail.
- ✧ Snapshot function allows you to save the current image as a JPG file in the SD card.
- ✧ LED Flashlight.
- ✧ 4GB Micro SD card included.
- ✧ LCD screen brightness/contrast/color Saturation adjustable
- ✧ Visual fault locator , to test fiber's bending and breakage (***Optional**)
- ✧ Optical power meter ,test fiber loss and value (***Optional**)
- ✧ Digital Multi-meter , DC and AC voltage measurement, Resistance measurement (***Optional**)
- ✧ Enhanced Color bar generator, PAL/NTSC multi-system color bar video generator (Eight-system switchable, transmit/receive eight-system colorful images).
- ✧ Cable tracer, by sending the audio signal, enables the blue cable tracer tester to find the

connected cable from messy cables. (***Optional**)

- ◇ Ping test, PING is the most conventional network debugging tools; it is used for testing if the connected IP camera or other network equipment's Ethernet port is working normally and the IP address is correct.
- ◇ In digital IP surveillance applications, if the IP camera's IP address is not known; the device cannot be used. An IP address scan can quickly search for the connected IP camera or other network device's IP address.
- ◇ The PoE voltage test can test for PoE voltage when a POE switch is supplying POE power to an IP camera
- ◇ TDR cable test, test cable open circuit and short-circuit (***Optional**)
- ◇ Cable test , Test LAN cable or telephone cable,UTP cable etc ,cable type and the sequence of wires will be displayed
- ◇ Support RS232/RS485,Rate 600 ~ 115200bps adjustable
- ◇ PTZ protocol analysis, control protocol command displays to check RS485 transmission whether is normal, easy to find the fault device
- ◇ PTZ control. Pan/tilts the P/T unit, zooms in/out the lens, adjusts the focus, aperture and sets and the preset position
- ◇ DC12V 2A output power for camera
- ◇ PoE 24W power output,supply temporary power for PoE camera
- ◇ DC5V 2A power output,as a power bank
- ◇ Audio input and output, test and output the audio signal
- ◇ 7.4V 48.1Wh Battery. Remaining battery charge indicator, Lithium Ion Polymer Battery can last 16 hours for normal use after charging for 8 hours

“*”Sign means the function Optional

2.3 Function

2.3.1 Touch screen and OSD menu

The IP camera tester combines touch screen control and physical buttons. This combination makes the tester very user friendly. The test meter allows you to move the function icons from the tester's main menu to the APPS folder or move them back to customize the main menu

2.3.2 WIFI

With built in WIFI, you can view the video from a wireless camera (ONVIF or customized camera) or connect to a Wireless network.

2.3.3 IP camera test

The device is designed for ONVIF IP camera testing. It can display the image from an IP camera and change the IP address. 4.3 inch 800×480 screen display allows the user to view the image with a sufficient screen size.

With the ONVIF tool, you can display the image from an IP camera and use the PTZ functions. Currently the IP camera tester supports more than 70 brands' IP cameras, such as most, ACTi, Dahua, Hikvision, Samsung, Honeywell and many more.

OEM service is available. Users can send us the IP camera for our engineers try to add the protocols to the tester, or send us the mobile apps (Android version. APK files) to install in the tester.

2.3.4 SDI camera test (*Optional)

SDI digital video surveillance testing, support 720p 60fps / 1080p 30fps / 1080i 60fps digital camera image test and video image zoom, record, screen snapshot, photo viewer and video playback .

2.3.5 CVI camera test (*Optional)

HD CVI video surveillance testing, support 720p 25,30,50,60fps / 1080p 25,30fps digital camera image test and video image zoom, record, snapshot, photo viewer, video playback, coaxial PTZ control and

call up the camera OSD menu

2.3.6 TVI camera test (*Optional)

HD TVI video surveillance testing, support 720p 25,30,50,60fps / 1080p 25,30fps digital camera image test and video image zoom, record, snapshot, photo viewer, video playback, coaxial PTZ control and call up the camera OSD menu.

2.3.7 AHD camera test (*Optional)

AHD video surveillance testing, support 720p 25,30fps / 1080p 25,30fps digital camera image test and video image zoom, record, snapshot, photo viewer, video playback, coaxial PTZ control and call up the camera OSD menu.

2.3.8 HDMI signal output

The HDMI output port supports up to a 1080p 60Hz resolution output.

2.3.9 Analog camera test

Display analog camera image ,4.3 inch 800×480 LCD screen display , supports PAL & NTSC formats. The LCD screen's back light brightness, video image brightness, contrast and color saturation are all adjustable.

2.3.10 Video level meter (*Optional)

Perform NTSC and PAL video amplitude signal measurements for PEAK to PEAK ,SYNC levels and COLOR BURST chroma level.

Video signal PEAK to PEAK level:

For NTSC format, the video signal level is 140 ± 15 IRE

For PAL format, the video signal level is 1000 ± 200 mV

If the level is too low, it will cause the image to lose quality and limit the distance it will travel over cable. If the level is too high, it will lead to wash out of the image

SYNC level: Testing the amplitude of the video sync pulse to verify if the video level is correct.

For NTSC format, the SYNC level is $40 \pm 5\text{IRE}$

For PAL format, the SYNC level is $300 \pm 35\text{mV}$

If the level is too low, it will cause the image to not frame out properly. If the level is too high, it will lead to a poor quality

COLOR BURST level: Testing the color burst level will determine if the burst signal is sufficient to trigger the displays color producing circuit. Burst will diminish in amplitude over longer cable runs and can get fall below the threshold for the video display to show a color image.

For NTSC format, the Chroma standard level is 40 IRE

For PAL format, the Chroma standard level is 280mV

If the Chroma level is too low, the color will not be as deep, and some details of the image will get washed out. If the Chroma level is too high, there will be spots on the image. If the coaxial cable is too long, it will reduce the chroma level

2.3.11 PTZ controller

Displays and allows for analysis of analog video and controls Pan/tilt/zoom function of PTZ analog cameras. For PTZ testing, setup the controlling parameters from the meter to match those of the camera: e.g. PTZ protocol (PELCO-D, etc.), communication port (RS-485, etc.), baud rate, PTZ camera ID and pan/tilt speed.

2.3.12 Enhanced Color bar generator

The tester sends out color bars via its BNC output to the monitor. This is used to test for a problem in the cable going from the camera back to the monitoring area

2.3.13 DC 12V 2A power output port and 5VDC 2A USB power port

The unit can power a camera with its 12V DC 2A power output. Also included is a built in 5V DC 2A

power output port used to charge USB devices. NOTE: This USB port is for charging only and has no ability to transfer data.

2.3.14 PoE power supply

Supports PoE 802.3at power at 48V and up to 24W.

2.3.15 Audio testing

Test the audio from mic level input devices. Connect the tester and mic level device with the audio cable. Supports audio recording and output. to monitor and / or record audio.

2.3.16 PTZ data analysis

Search the Control protocol code from Multifunction keyboard or DVR by RS485 /RS232 interface, test the PTZ control command data whether received anomaly and RS485/RS232 data transmission.

Screen displays 16 hexadecimal codes such as

PELCO-P:A0 00 (Add) xx xxxxxx AF xx

PELCO-D:FF 01 (Add) xx xxxxxxxx

2.3.17 Digital Image zooms on the monitor

Set image zoom up to 4X to get a closer look at all the image detail. Supports analog and many IP cameras

2.3.18 Video screenshot

Capture the video image displayed , and save as JPEG file in the SD card.

2.3.19 Record

Capture and save the current video in the SD card.

2.3.20 Playback

The recorded files can play directly via Media player or under the function of "Playback".

2.3.21 Cable Tracer (cable search) (*Optional)

Cable identification by use of an audio signal. This function enables the blue cable tracer to find the connected cable from a bundle of cables with an audio tone.

2.3.22 DHCP dynamic address assignment

Built in DHCP server: Dynamically assign IP address for the IP camera or network device.

2.3.23 Access the dynamic IP address

The IP tester can directly access a dynamic IP address assigned from its DHCP server and use it as the tester's IP address. No need to set a IP address manually.

2.3.24 Multi- segments IP Cameras Test

Support Multi- segment Static IP address setting, which can simultaneously test different segments IP network cameras.

2.3.25 Network bandwidth testing

The network bandwidth test needs two IP testers to test bandwidth: one as a transmitter, the other as a receiver.

2.3.26 IP address scan

The IP address scan can quickly search for connected IP cameras or another network device IP address.

2.3.27 PING Test

PING is the most conventional network debugging tools; It is used for testing if the connected IP camera or other network equipment's Ethernet port is working normally and the IP address is correct.

2.3.28 Port Finder

The tester will send signals to make the connected PoE port flicker at a set frequency. This will enable the installer to easily and quickly find the connected port for an Ethernet cable.

2.3.29 PoE Test

Test the PoE voltage from a PoE switch. The unit will clearly display the voltage for each wire in an

Ethernet cable.

2.3.30 Digital Multi-meter (*Optional)

The tester has built in highly stable and reliable 33/4 digit (6600) digital multi-meter. It is used for the DC and AC voltage measurement, AC and DC current measurement, Resistance measurement, Continuity test, Diode measurements, Capacitance measurement, Auto/Manual measuring range switching, relative value measurement and locking. It is easy operation and professionally accurate.

2.3.31 Visual fault locator (*Optional)

Visual Fault Locator with 650nm wavelength can emit red laser sources to test multi-mode and single mode fiber's bending and breakage, and Continuous light-emitting and 1HZ, 2HZ modulating light output. It is indispensable tool in fiber project constructing, fiber net-work maintaining, optical component manufacture and research.

2.3.32 Optical Power Meter (*Optional)

The IP camera tester adopts the most advanced handheld instrument specific integrated chip , achieve ultra-low power operation, with the 4.3 TFT-LCD High-definition screen display ,five wavelength calibration points 1625nm,1550nm,1490nm,1310nm,1300nm,850nm.Linear or nonlinear optical power display, it can measure the optical power value, and also be used for Relative measurement of optical fiber link loss. It is necessary tool for fibre-optic communication, cable television system and security system maintenance.

2.3.33 LED Flashlight

Press the LED On/Off button to use the LED flashlight.

2.3.34 Screen image rotates 180 degrees

You can manually rotate the display 180 degrees using the settings.

2.3.35 TDR cable open circuit and short circuit measurement (*Optional)

TDR cable testing, accurately measure BNC cable, network cable, controls cable's open circuit and short-circuits location. It greatly improves working efficiency.

2.3.36 FTP Server



















Start the tester's Wi-Fi or connect the tester's LAN port to the network. Once the tester is online, start its FTP Server and directly access files from the tester's SD card. This also allows for the user to upgrade the tester firmware.

2.4 Packing list

- 1). Tester
- 2). Adaptor DC12V 2A
- 3) Network cable tester
- 4) Polymer lithium ion battery (7.4V DC 5000mAh)
- 5). BNC cable
- 6). RS485 cable
- 7). SC,ST connector (Only for optical power meter)
- 8). Multi-meter test leads one pair of red and black (only for the Multi-meter models)
- 9). Output Power cable
- 10). Audio cable
- 11). TDR alligator clamp (only for TDR models)
- 12). Safety cord
- 13). Tool bag
- 14). Manual
- 15) 4G SD card

2.5 Function interface



1		Press more than 2 seconds, turn on or off the device ,short press to turn on or off the menu display
2		Set key
3		Menu key
4		Near focus: Focus the image nearby
5		Far focus: Focus the image faraway
6		TELE: zoom in the image
7		WIDE: zoom out the image
8		Open/set ,Confirm the setting of parameters, open or enlarge the aperture
9		Return/Close : Return or cancel while setting parameters of the menu, close or decrease the aperture
10		Upward, set function or add parameter. Tilt the PTZ upward
11		Rightward, select the parameter whose value will be changed. Add the value of the parameter. Pan the PTZ right
12		Confirm key
13		Leftward, select the parameter whose value will be changed
14		Downward, set function or reduce the value of the parameter. Tilt the PTZ downward
15		Snapshot
16		Video record
17		Open/set ,Confirm the setting of parameters, open or enlarge the aperture
18		Return/Close : Return or cancel while setting parameters of the menu, close or decrease the aperture
19		The power indicator: it lights green while the tester is powered on by the adapter

20	The data accepted indicator: it lights red while the data is being received
21	The RS485/RS232 data transmission indicator: it lights red while the data is being transmitted
22	The charge indicator: it lights red while the battery is being charged. As the charging is complete, the indicator turns off automatically
23	Multimeter interface (Optional)

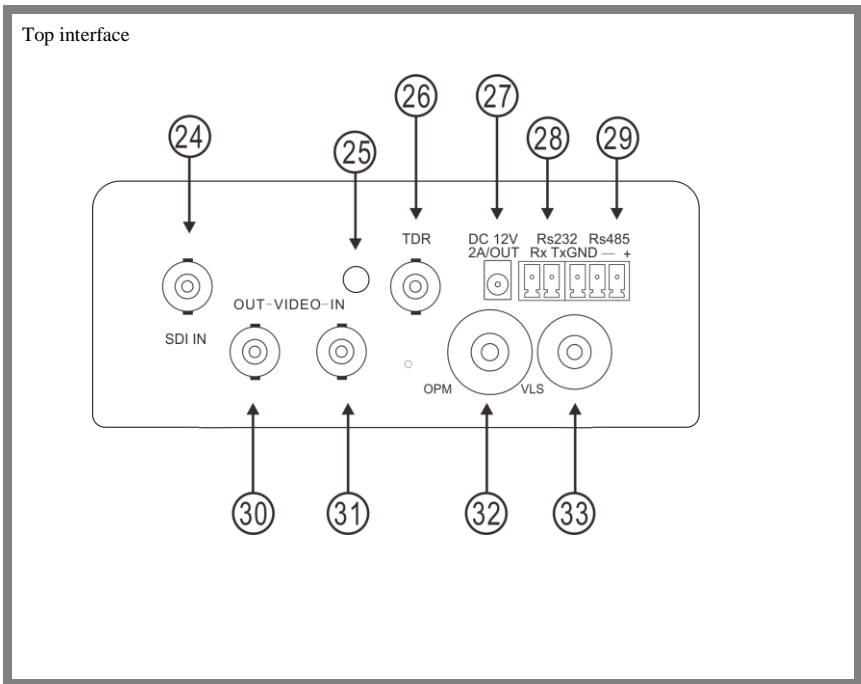

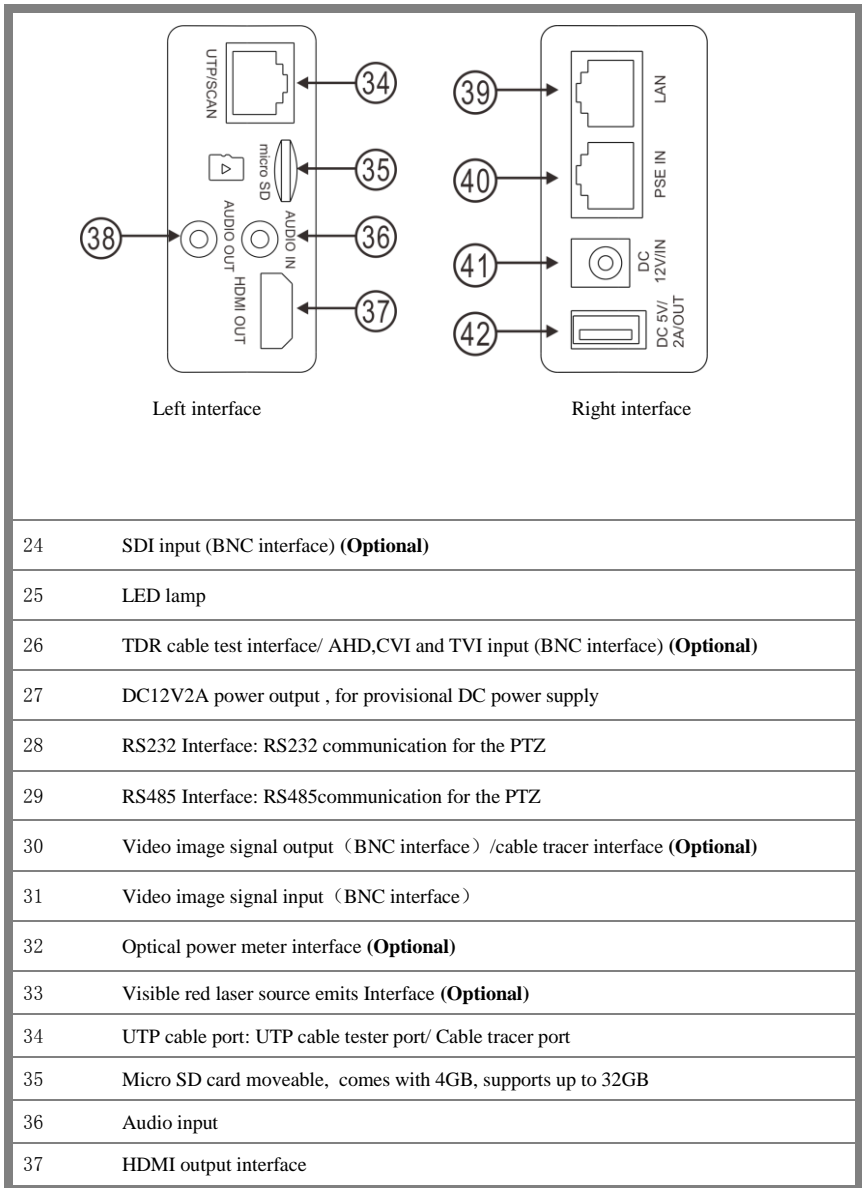

38	Audio and earphone output
39	PoE power supply output or LAN test port (Use to test PoE or non-PoE IP camera)
40	PSE power sourcing equipment. Tests PoE voltage
41	DC12V2A charging interface
42	DC12V2A power output , for provisional DC power supply

3. Operation

3.1 Installing the Battery

The tester has built-in lithium ion polymer rechargeable battery. The battery cable inside battery cabin should be disconnected for safety during transportation!

Usually it doesn't need to disconnect the cable at the normal use

Pressing the key  continuously can power on or off the tester.



Notice:Pls use the original adaptor and connected cable of the device!



When the battery icon is full or the charge indicator turns off automatically, indicate the battery charging is completed



When the Charge Indicator  turns off, the battery is approximately 90%

charged. The charging time can be extended for about 1 hour and the charging time within 12 hours will not damage the battery.



Notice :Press the key  several seconds to restore the default settings when the instrument works abnormally.

Multi-meter: the red and black multi-meter pen must insert the corresponding port.



Warnings:Instrument communication port is not permitted access circuit voltage over 6V, otherwise damage the tester.



Warnings:Not allow insert multi-meter pen in the current terminal to measure voltag

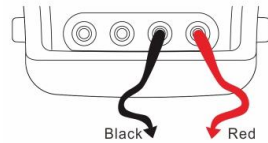

3.2 Instrument connection

3.2.1 IP camera connection

Power an IP camera with an independent power supply, then connect the IP camera to the IPC tester's LAN port, if the link indicator of the tester's LAN port is green and the data indicator flickers, it means the IP camera and the IPC tester are communicating. If the two indicators don't flicker, check if the IP camera is powered on or the network cable is not functioning properly



Note:1) If the IP camera requires PoE power, then connect the IP camera to the IP tester's LAN port . The tester will supply PoE Power for the IP camera. Click on the icon labeled POE to turn the PoE Power off or on.

2)If use the tester's menu to turn off the tester's PoE power supply, the PoE switch and the power sourcing equipment are allowed to connect to the tester's PSE port, and the PoE power will be supplied to the IP camera by the tester's LAN port. On this condition, the tester cannot receive data from IP camera, but the computer connected to the PoE switch can receive the data via the the tester.



Warning:PoE switch or PSE power sourcing equipment only can be connected to tester "PSE IN" port, otherwise will damage the tester.

3.2.2 Analog camera connection



- (1) Connect the camera's video output to the IP tester's VIDEO IN. The image will display on the tester after pushing the PTZ icon
- (2) IP Tester "VIDEO OUT" interface connect to the Video input of monitor and optical video transmitter and receiver, the image display on the tester and monitor
- (3) Connect the camera or the speed dome RS485 controller cable to the tester RS485 interface ,(Note positive and negative connection of the cable).Support RS232 PTZ controller ,connect the RS232 cable to RS232 interface of the tester

3.2.3 HD Coaxial camera connection





*SDI, CVI, TVI, AHD camera are classified as HD coaxial cameras. Hereby the following instruction of how to connect SDI camera to the tester is also applied to CVI, TVI and AHD camera.



- (1) Connect the SDI camera's video output to the IP tester's "SDI IN" interface, the image will display on the tester. The tester only come with SDI input interface. There is no SDI output interface.
- (2) Connect the SDI camera or the speed dome RS485 controller cable to the tester RS485 interface,

(Note positive and negative connection of the cable).Support RS232 PTZ controller, connect the RS232 cable to RS232 interface of the tester.

3.3 OSD menu

- Press the key  2 seconds to turn on
- Press the key  2 seconds to turn off
- short press the key  to enter sleep mode,press it again to test if tester work abnormally and cannot be turned off , Press the key  several seconds to turn off, the tester reset



Select Icons to enter, if quit, Please click 



Click SD card, install or remove SD card



Press function Icons seconds, tip: whether move this icon to APPS file, if some function not be often used, can move these function icons to APPS.



To move an app icon to the “APPS” folder, press and hold until the “move to apps directory” appears on the screen then press OK to move it or Cancel



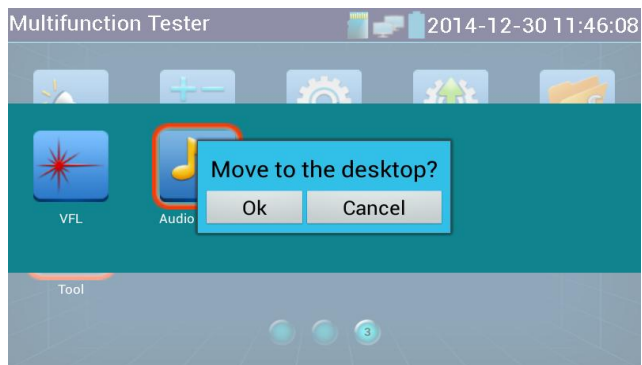

In APPS file, Select icon and press it for seconds, tip: whether move the file to the desktop?



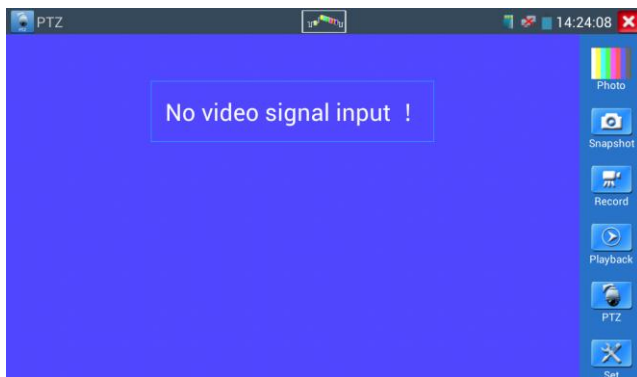

3.3.1 Video monitor test (PTZ control)

Analog camera test and PTZ control, click icon  to enter



Display the input video image, click the top menu bar icon  to enter video level meter, (PEAK level, SYNC level, COLOR BURST measurement)

Select relative function on the right side Toolbar to operate , functions including “Photos”, “Snapshot”, “Record”, “Playback”, “PTZ”, “Set”,

Click  to quit, or press  back to menu.

Click the screen twice quickly, can be full zoom in on the touch screen.

(1) PTZ controller parameter setting

Select and click icon “PTZ”,to enter PTZ setting:

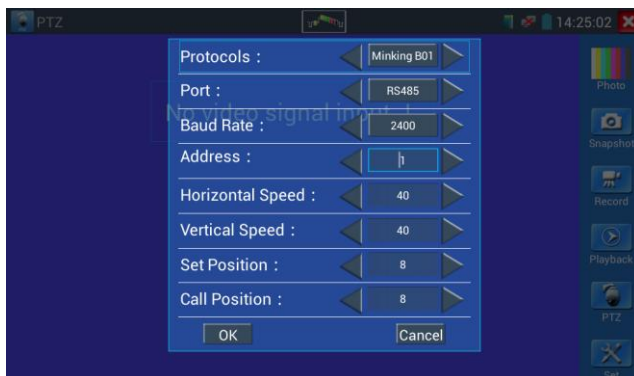

A. Protocol

Use the up and down arrow keys to move the yellow cursor to the “protocol”, set corresponding Protocol and support more than thirty PTZ protocols. Such as Pelco-D, Samsung, Yaan, LiLin, CSR600, Panasonic, Sony-EVI etc.

B. Port

Click and move, to “port” Select the communication port for the PTZ camera controlling (RS232/485)

C. Baud

Move the yellow cursor to “Baud”, Select the baud rate according to baud rate of the PTZ camera.(150/300/600/1200/2400/4800/9600/19200/57600/115200)

D. Address

Set the ID according the ID of PTZ camera (0~254), the setting address data must be consistent the speed dome address.

E. Pan speed: Set the pan speed of PTZ camera (0~63)

F. Tilt speed: Set the tilt speed of PTZ camera (0~63)

G. Set preset position (Set PS)

Click and select “Set PS”, set and save preset position number(1~128),

H. Call the preset position (Go ps)

Click and select “Set PS”, set and save preset position number (1~128), click “sure” to save,

Call some special preset number, can call the dome camera menu





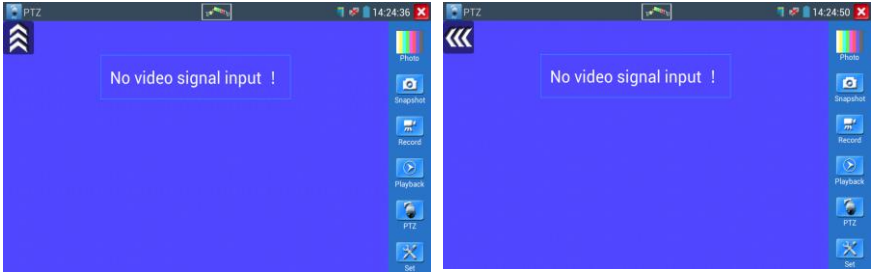

Check and set the protocols, address, interface and baud, all must be consistent with the dome camera, dome camera, then the IPC tester can test .After setting the parameter, the tester can control the PTZ and lens

To control PTZ by screen touch:

Tap left, right, upward and downward on the touch screen to control the PTZ rotation direction. By two fingers move outward and inward on the touch screen to zoom in and out the PTZ.



- ◆ Press the key     control the PTZ direction of rotation
- ◆ Press OR to switch on or turn off the aperture.
- ◆ Press OR adjust the focus manually
- ◆ Press OR manually adjust the zoom

(2) Video and storage setting

Click icon “set”, to enter and set analog video image brightness, contrast, color saturation, screen snapshot, recording and storage, support Auto-storage and manual storage

When select manual storage, user can name and store the files.



(3) 4 x zoom image display and Video out

When image input, press  to enter “zoom”, press it again to quit.

Using the touch screen to control PTZ camera movement:

Tap left, right, upward or downward on the video image to move the PTZ camera in a desired direction.

Stretch two fingers outward or inward on the touch screen to zoom the image in or out.

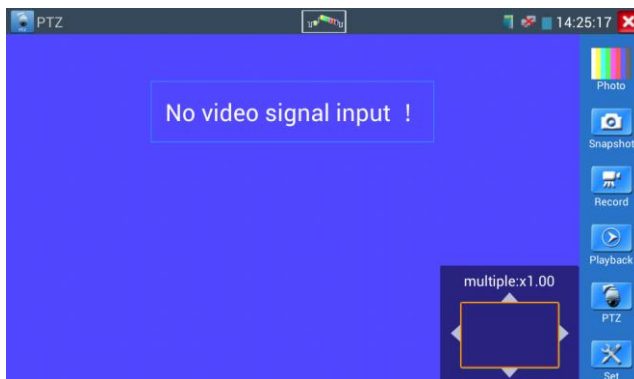

if not use touch screen to operate ,press the key to zoom out , press the key to zoom in, press upward and downward key to move the image



For analog video input, as the resolution is 720*480, it is normal that the zoom in image is not clear. But for network digital video input, as it supports resolution up to 1280*960, the zoom in image is still very clear. This is very helpful for IP camera installation.

(4) Snapshot

Click the icon “Snapshot “, when the video in, to snapshot and save the current video frame in the SD card as JPEG file.

If the unit is set to the manual mode an “Input Name” pop up box will appear and you can enter a title for the snapshot. If the unit is set up to automatically set file names, this box will not pop up.

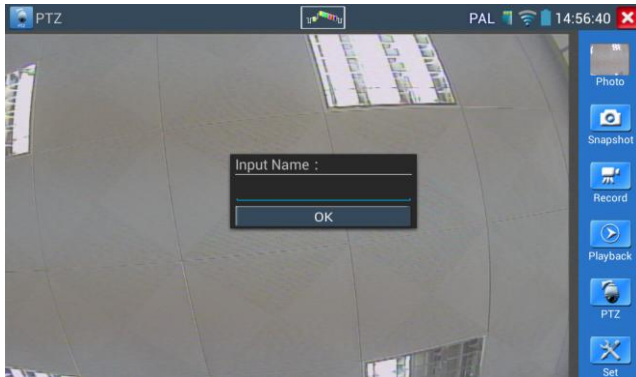

(5) Video record

When you click the “Record” icon, video starts recording. A red recording icon appears on the screen and begins to flash and a timer appears indicating the time elapsed for the video. Click on the “Record” icon again to stop recording and save the video file to the SD card.

if select manual storage, before recording begins ,appears dialog box “Input Name” ,user-defined the files name(by Chinese character, English letter ,or digit) to store in SD card , tester will hereby store the files in SD card after recording ., if select “Auto-storage ”tester will auto store the files in SD card after recording .

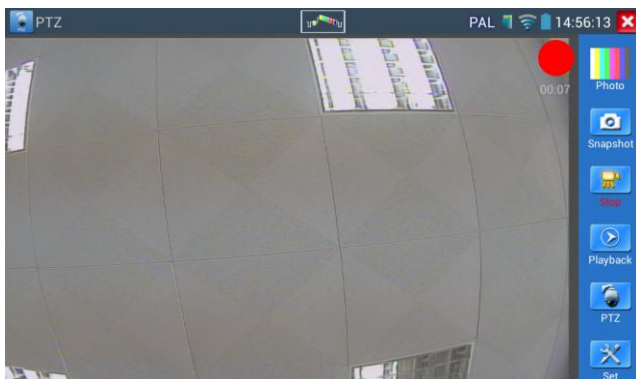

(6)Photo

Click the icon “photo” to enter, click the selected thumbnail photo to display it on the screen.

Double-click the photo to make it full display. Double-click again the photo to return.

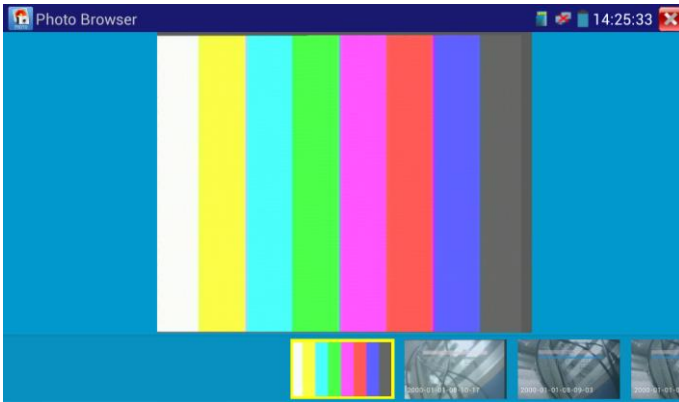

To rename or delete an image, click and hold on the file until this screen below appears

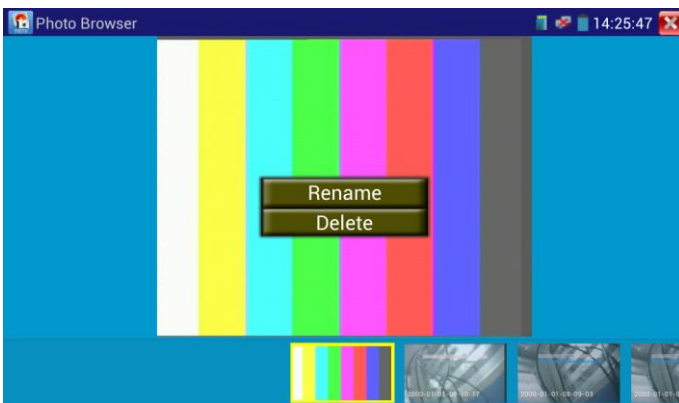

Click  to close and return to PTZ controller.

(7) Recorded video playback

Click the “Playback” icon to view your recorded videos. Tap on the video file image you want to watch.

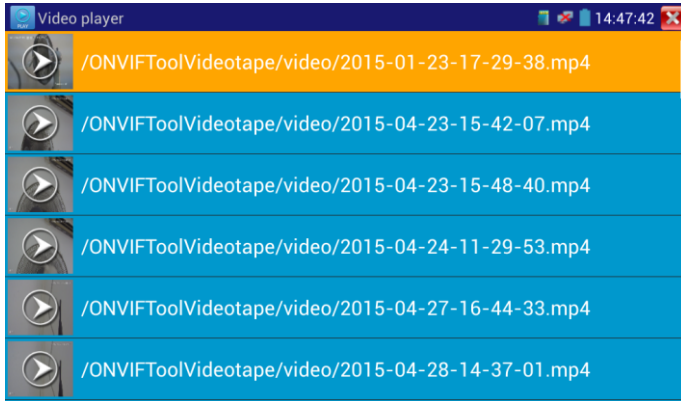

To rename or delete a video, click and hold on the file until this screen appears:

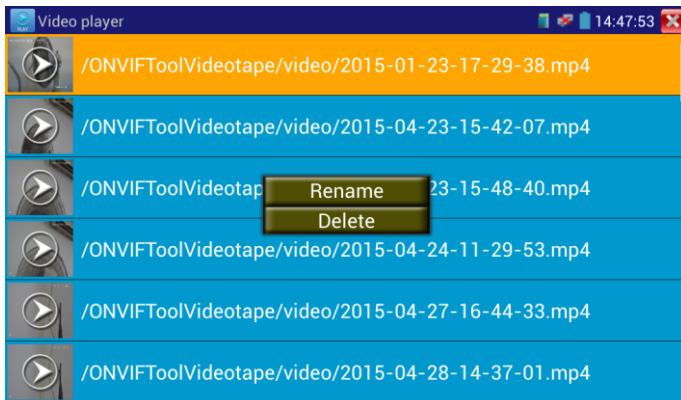

Video files also can play in the main menu “Video Player”.

(8) Video level meter (*Optional)

Click the icon  to enter, the IP camera tester has adopted hardware high-speed sampling and processing technology, can perform both NTSC and PAL video amplitude signal measurements for PEAK to PEAK, SYNC levels and COLOR BURST chroma level, When an analog signal is fed into the meter, the tester displays the measurements on the bottom left corner of the screen

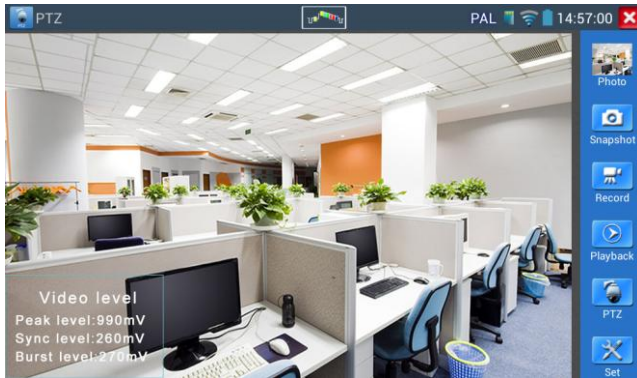

While in PAL format, the unit will be mV, While in NTSC format, it will be IRE.

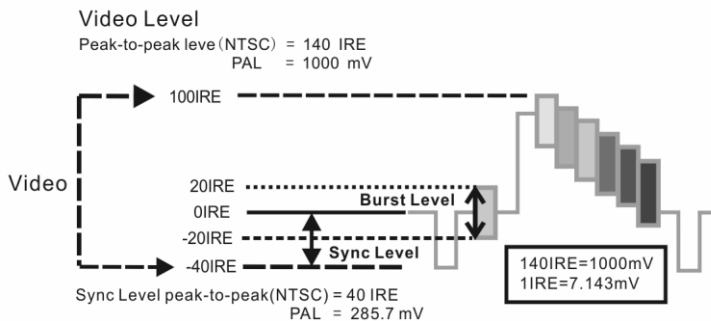

NTSC	Video signal level	140±15IRE
	Chroma level(COLOR BURST)	40±5IRE
	SYNC signal level	40±5IRE
PAL	Video signal level	1000±200mV
	Chroma level(COLOR BURST)	300±35mV
	SYNC signal level	300±35mV

Video signal PEAK to PEAK level:

For NTSC format, the video signal level is 140±15IRE

For PAL format, the video signal level is 1000±200mV

If the level is too low, it will cause the image to lose quality and limit the distance it will travel over cable. If the level is too high, it will distort the image.

SYNC level: Tests the amplitude of the video sync pulse to verify if the video level is correct.

For NTSC format, the SYNC level is 40 ± 5IRE

For PAL format, the SYNC level is 300 ± 35mV

If the level is too low, it will cause the image to not frame out properly. If the level is too high, it will lead to a poor quality image.

COLOR BURST level: Testing the color burst level will determine if the burst signal is sufficient to trigger the displays color producing circuit. Burst will diminish in amplitude over longer cable runs and can get fall below the threshold for the video display to show a color image.

For NTSC format, the Chroma standard level is 40 IRE

For PAL format, the Chroma standard level is 280mV

If the Chroma level is too low, the color will not be as deep, and some details of the image will become lighter. If the Chroma level is too high, there will be distortions on the image. If the coaxial cable is too long, it will reduce the chroma level.

Image loop test: Test video optical transmitter and receiver and video cable, connect one end to the tester “VIDEO OUT” port ,and the other end connected to “VIDEO IN” port, the signal send via “VIDEO OUT” port ,and received via “VIDEO IN” port , If the testing is ok, the tester displays

several gradually dwindling photos on the desktop.

3.3.2 Color-bar generator (TV OUT)

Click  to enter, the tester send the color bars from the “Video out” port ,Click the icon “PAL”, select “PAL/NTSC” output formats

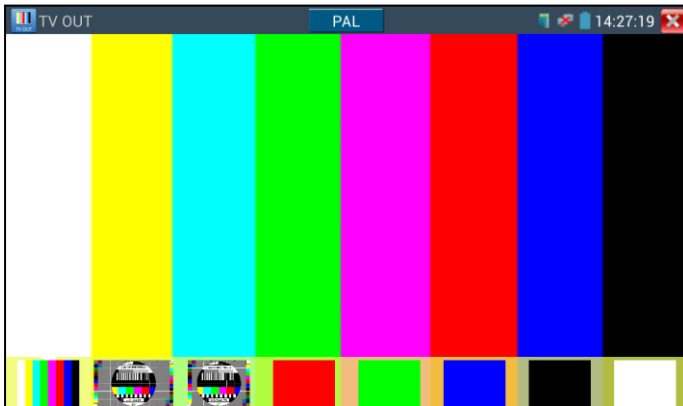

Click the selected color-bars, testing image or single bar (red, green, blue, white or black). Double click to full display on the screen and output, click  to return main menu.

Application

- A. When maintaining the dome camera, the tester sends out the color bar by its BNC output to the monitor at the monitoring center. If the monitor receive the color bar, it means the video transmit channel works normally. Meanwhile on the basis of the received color bar, the monitoring center can judge if transmission has loss or interference.
- B. The tester sends out the pure color bar (such as white and black color), to test the monitor whether has bright or black dots
- C. The tester sends out video signal image to test if the image received by the monitor has excursion.

3.3.3 ONVIF

The Open Network Video Interface Forum (ONVIF) app is used to connect to ONVIF compliant IP

cameras only. If the IP camera's video stream is MPEG4, use the ONVIF (SD) mode. If your IP camera's video stream is H.264, use ONVIF HD (High Definition), HD mode cannot support MPEG4. While in SD mode, if the network camera resolution is 720P or higher 720P, the image display may be delayed. While in HD mode, if the network camera stream is H.264, the tester can fluently display the image up to 1080P.

Click icon  to enter ONVIF, then tap either the "ONVIF" icon is for SD mode (MPEG4) and the "ONVIF HD" icon is for HD mode (H.264).



If you select ONVIF SD or HD mode, the meter automatically scans different network segments for ONVIF cameras. It lists the camera name and IP address on the Device List. If no cameras appear under the device list, try clicking on the Refresh button

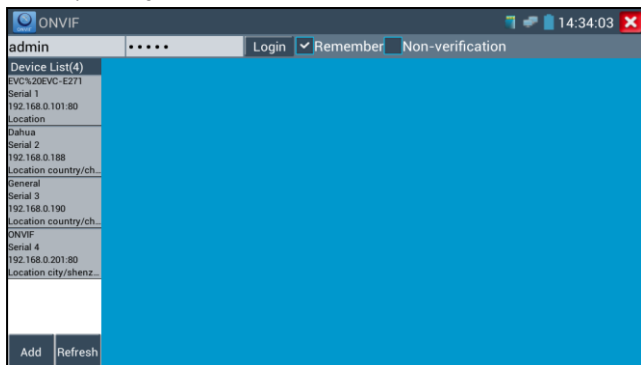

If your IP camera does not appear after scanning the network, you can manually add an IP camera by clicking on the “Add” button on the bottom left. The URL address should be identical to the ONVIF camera service address. (With your camera’s IP address entered into the URL). Click OK to add the manually entered camera and then click the “Refresh” button.

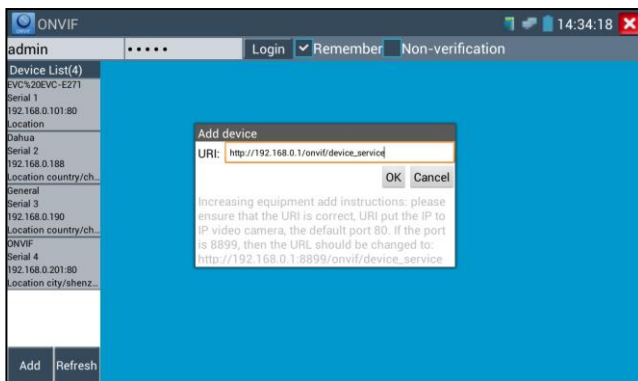

Click the button “Refresh”, tester will scan the ONVIF camera again the new displayed ONVIF camera below “Device List“, the tester will show the IP camera relative information and settings.

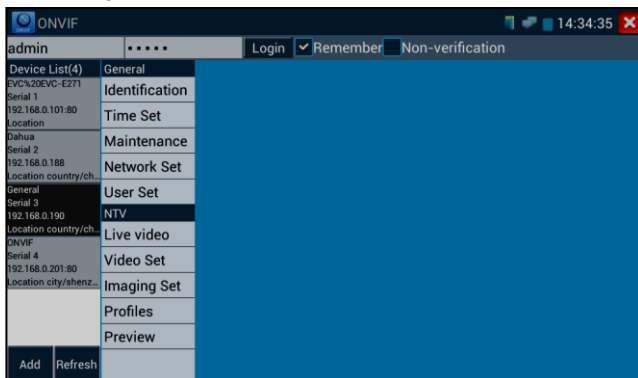

After selecting your ONVIF camera, enter the IP camera’s username and password at the top left of the screen and then click “Login”. After you log in, click on the camera under “Device List”. Once you are

connected to the camera, the following options become available: Identification, Time Set, Maintenance, Network Set, User Set, Live Video, Video Streaming, Image Set and Profiles.

Live Video: Click “Live Video” to view the live video feed from the IP camera. To make the image full screen, double tap on the video. Stretch two fingers outward or inward on the touch screen to zoom the image in or out.

While in the “Live video” menu, click “Video Menu” at the top right of the image to access the following tools: **Snapshot, Record, Photo, Playback, PTZ and Settings**

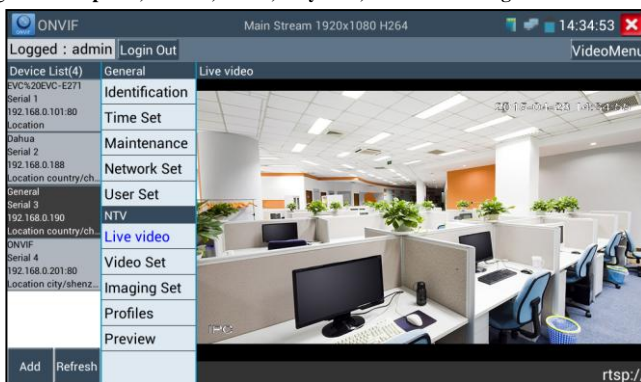

ONVIF PTZ control: Tap the image in the direction you want the PTZ camera to move. Tap the left side of the image to move left, right to go right, up to go up and down to go down. Compatible IP PTZ cameras will rotate accordingly. PTZ rotation direction is displayed on top left corner of the image.

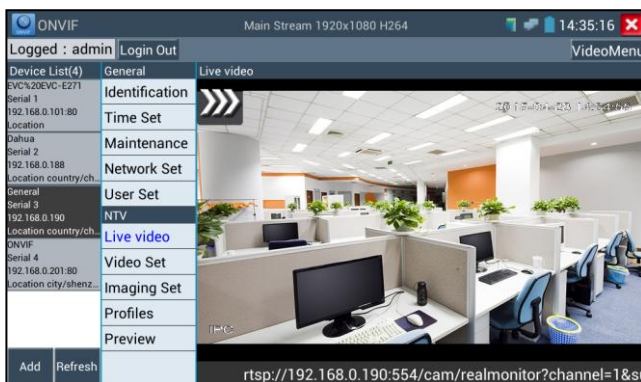

IP camera video settings: Click “Video Set” to enter the IP camera’s encoder and resolution settings.

Make the desired changes and click “OK “to save.

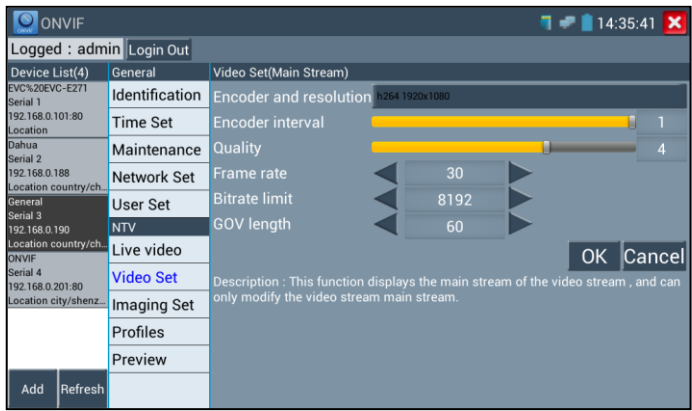
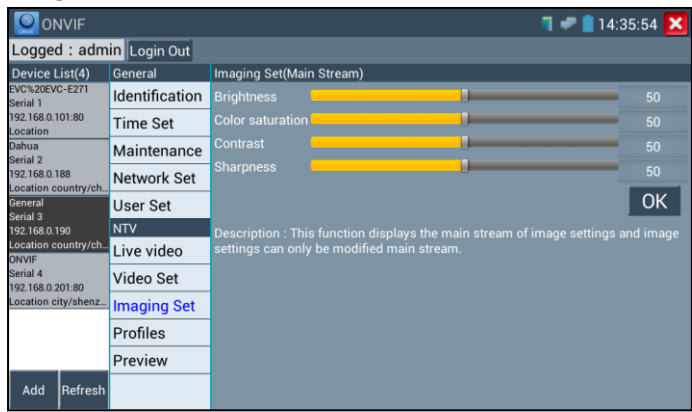
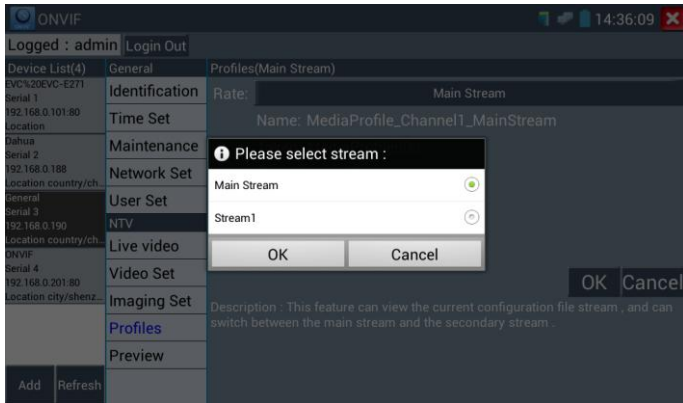

Image setting: Click “Imaging Set” to adjust image brightness, saturation, contrast, sharpness and backlight compensation mode.



Profiles: Click “profiles”, can view video streaming current configuration files, as well as switch between Major stream and minor stream



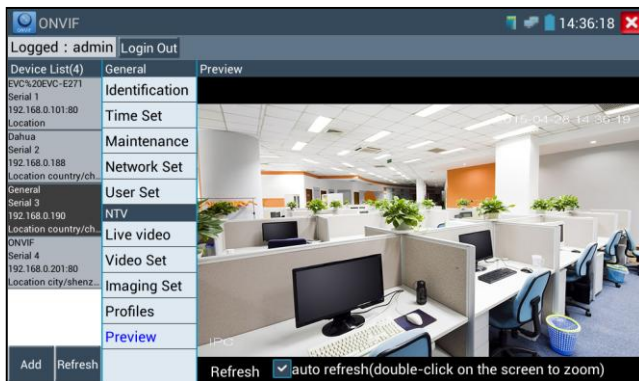

Preview pictures: Quickly preview and zoom in or out pictures, automatically and manual refresh



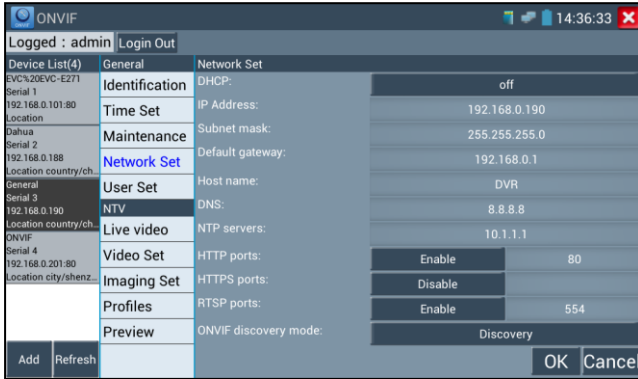

Network setting: Click “Network Set” to change the IP address settings.

Note: Some cameras are not fully ONVIF compliant and cannot support changing their IP address, so there is no change after saving.

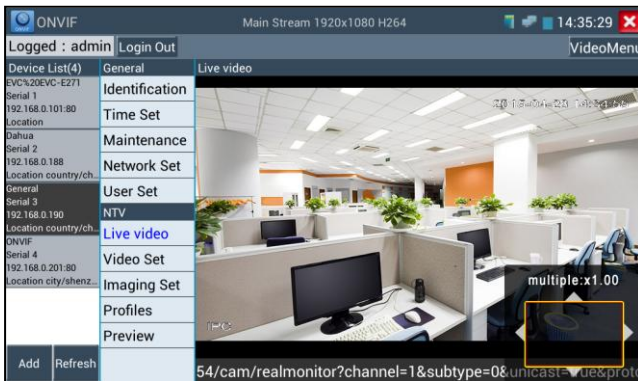

Zoom in image: press the key  key to enter the zoom mode. Press it again to exit zoom mode. When the image is enlarged tap left, right, up or down on the image to move the whole image on the screen



When the image is enlarged, if not operate on touch screen, it can operate by the keyboard ,press the key  to zoom in , press the key  to zoom out ,press upward and downward key to move image .



If it is network video input to the tester, as the tester supports resolution up to 1080p, the input image will be very clear after it is enlarged. This is greatly helpful for the installers to ensure the IP camera's video coverage and decide the IP camera's install site.

Image can only be enlarged on SD mode (The icon "ONVIF" is SD mode.)

IP camera video settings: Click "Video Set" to enter the IP camera's encoder and resolution settings. Make the desired changes and click "OK" to save.

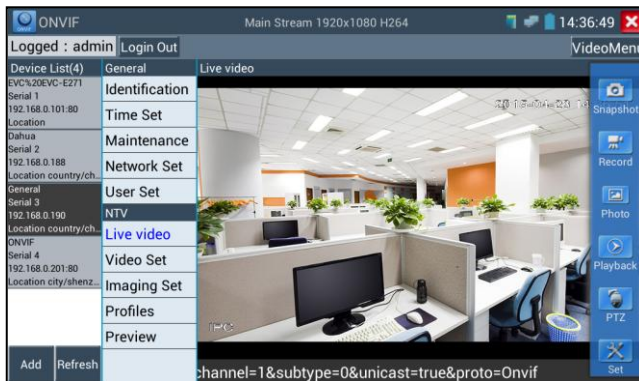

Snapshot: Click "snapshot" to save the current image as a JPEG file on the SD card if select manual storage, appears dialog box "Input Name", user-defined the files name(by Chinese character, English letter ,or digit) to save in SD card, if select "Auto- storage", the tester auto stores the files after snapshot.

Record: When you click the "Record" icon, video starts recording. A red recording icon appears on the screen and begins to flash and a timer appears indicating the time elapsed for the video. Click on the "Stop" icon to stop recording and save the video file to the SD card.



Set: Click on the “Set” icon to change Snapshot and Video recording file name settings. You can set Auto storage, which sets filenames by time or set manual storage. Click “Sure” to save file name settings.

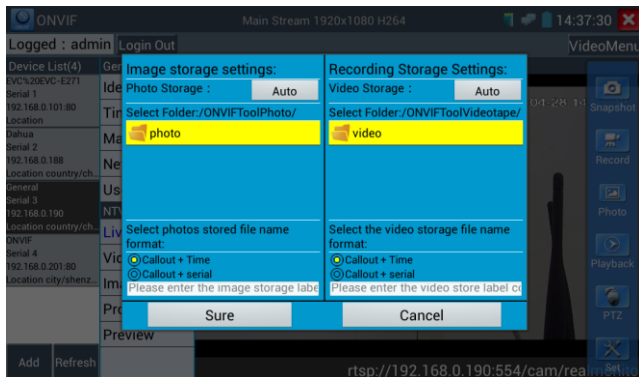

Playback: Click the “Playback” icon to view saved videos. Double click the video you want to play. Click to return to the last menu

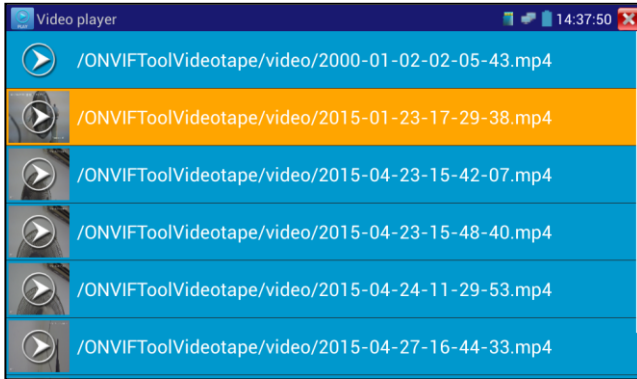

To rename or delete a photo, click and hold on the file until this screen appears:

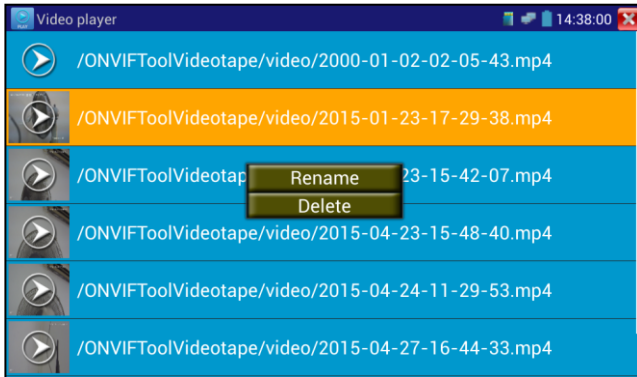

Video files can play in the Video player of the main menu

3.3.4 IP camera test

The "IPC Test" app is used for IP cameras that are fully integrated by name with the IPC tester device .

If the IP camera's video stream is MPEG4, use the IPC Test (SD) mode. If your IP camera's video stream is H.264, use IPC HD (High Definition)

Click icon  to enter IP camera test

Display high-definition images, support snapshot, video record and playback. Currently, the IPC tester

only support some brands' specified IP cameras, the brands include Dahua , Hikvision, Kodak , Samsung, etc. OEM service is available. Clients can send us the IP camera for our engineers to try to add the protocols to the IPC tester, or send us the **mobile apps** (Android version. APK files) to install in the tester.



Note: Currently, the IPC Test App only supports some brands' specific IP cameras; these include specific models made by ACTI, AXIS, Dahua, Hikvision, Samsung, and many more. If the camera is not fully integrated, please use the ONVIF or RTSP apps.

IPC test interface



Local IP:: This is the tester's IP address. Click "Edit" to enter "IP setting" and change the tester's IP

address settings

IP camera type: Click on the IP Camera type to select the Manufacturer and model number of the integrated IP camera

1. When IP camera type is “Manual”,Pls select type by manually.

Click IP camera type, list Honeywell , Kodak,Tiandy, Aipu-waton, ACTi,WoshiDA IP camera etc. If the brand has offered official original protocols, pls select camera type, input IP camera address ,user name and password ,click” official” to enter the camera image display interface(Currently, only support DAHUA official protocols)

2.when “IP camera type” is “Auto” ,the tester auto- match the camera type.

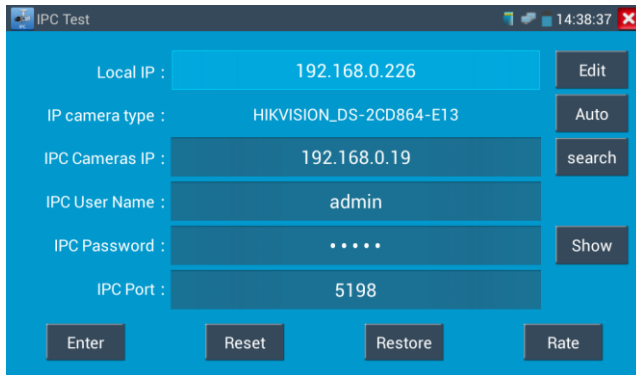

IP Camera's IP: Enter the IP camera's IP address manually or click “Search” to auto-scan for the IP camera's IP address. It is better to directly connect the IP camera to the tester so the search results will only display the camera's IP address. If the tester is connected to a PoE switch, it will find and display several IP address

IPC User Name: Enter IP camera's user name

IPC Password: Enter IP camera's password

IPC Port: When you select the IP camera type, it will default the camera's port number and doesn't need to be changed.

After all settings are completed, click “Enter” to view the live video

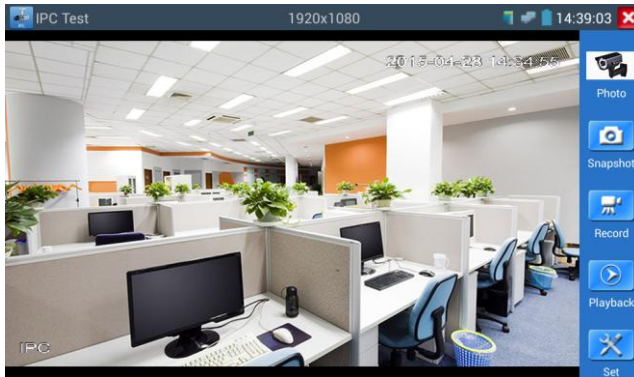

If IP address setting has error or IP camera is not connected.. The tester prompts “Network Error”
 Click  to quit from image display and return to IP camera test interface.



Once you are viewing video on the IPC Test app, you will see the “Video Menu” icon on the top right. This button will give you access to Snapshot, Record, Photo, Playback, PTZ, and Set. Please refer to the ONVIF section to use these functions.

3.3.5 SDI Camera Test (* Optional)

SDI camera test, Dome camera test and PTZ control, click icon  to enter.

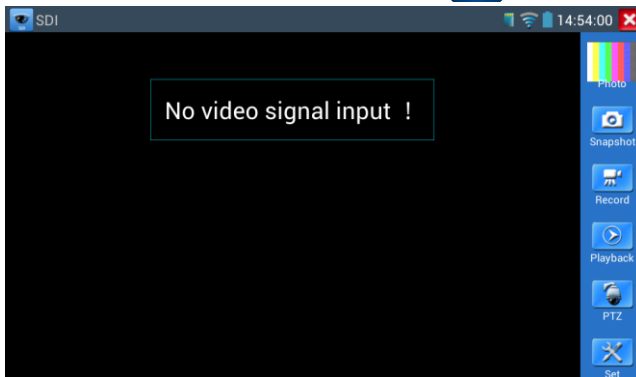

When tester receives SDI camera image, it will display the image data .

Double-taps on the screen to make the image displayed full screen.

The tester supports resolution as follows:

1280x720P 25Hz

1280x720P 30Hz

1280x720P 50Hz

1280x720P 60Hz

1920x1080P 25Hz

1920x1080P 30Hz

1920x1080I 50Hz

1920x1080I 60Hz

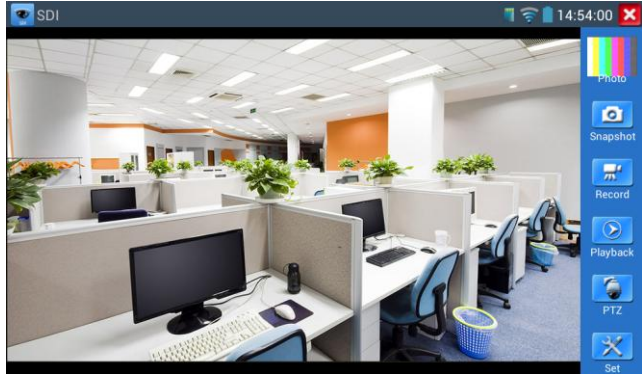

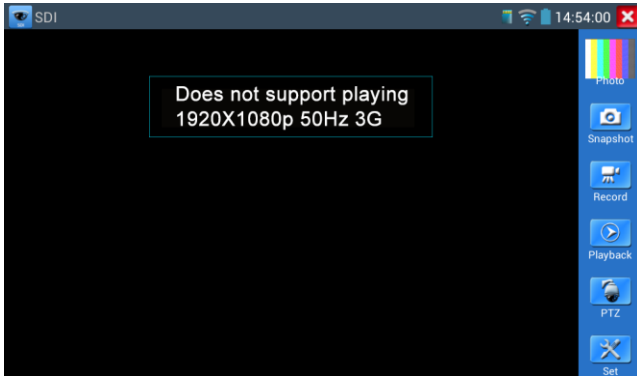

When SDI tester detects the camera input image resolution is 1080p 60Hz or 1080p 50Hz, the tester's screen will display "Does not support playing 1920*1080p 60Hz".



If no SDI camera image input, the tester's screen display "NO video signal input!":

IPC tester's HDMI output port can be use as SDI to HDMI converter, output HD SDI image to HD TV monitor.

Select relative function on the right side Toolbar to operate , "Snapshot" , "Recording", "Photos" , "Video playback", "PTZ control", "Brightness and Storage set", its operating as the same as the video monitor function, please refer to the relevant instructions "3.3.1" in the manual.

Click  or press  to quit and return the main menu.

3.3.6 CVI camera test (* Optional)

HD CVI camera, CVI dome camera test and PTZ control, Click icon  to enter

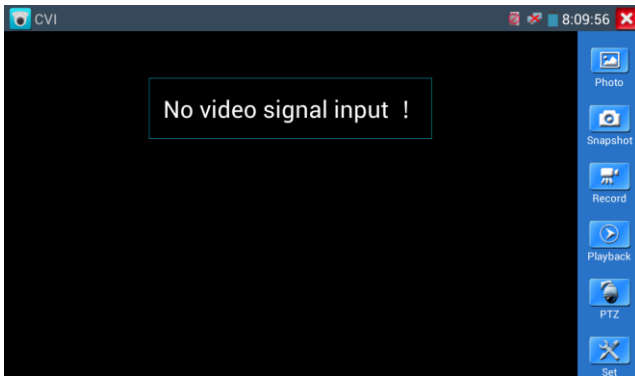

When HD CVI signal input, tester will display the image's resolution on the top bar.

Double-taps on the screen to make the image displayed full screen.

The tester supports resolution as follows:

1280x720P 25FPS / 1280x720P 30FPS / 1280x720P 50FPS / 1280x720P 60FPS

1920x1080P 25FPS / 1920x1080P 30FPS

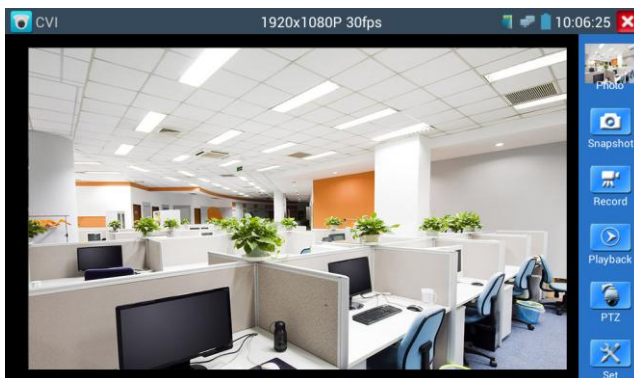

(1) PTZ control

1.1 Coaxial PTZ control

Click the icon“PTZ”on the right toolbar to do the corresponding setting.

“Port”: select coaxial control

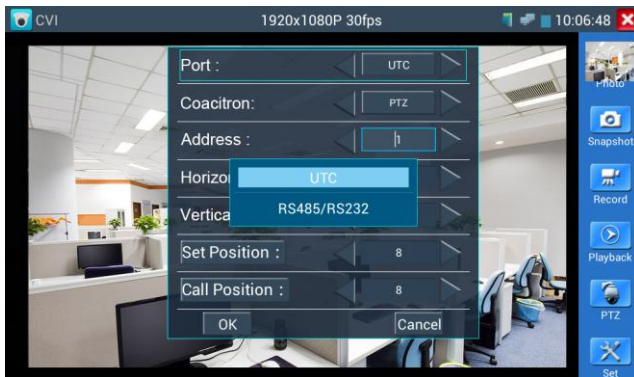

Enter PTZ address to perform parameters setting



Operation instructions please refer to “3.3.1 PTZ (1) PTZ control parameters setting”



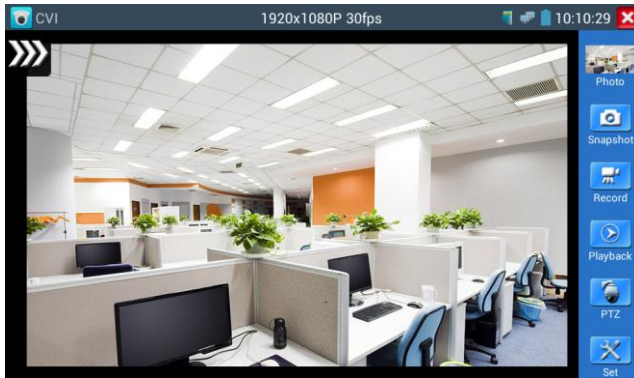

The PTZ address in the tester must be consistent with the dome camera or decoder, then the IPC tester can test .After setting the parameter, the tester can control the PTZ and lens.





To control PTZ by screen touch:

Tap left, right, upward and downward on the touch screen to control the PTZ rotation direction, PTZ cameras will rotate accordingly. By two fingers move outward and inward on the touch screen to zoom in and out the PTZ.

To control PTZ by key buttons

Press arrow keys   to control the PTZ direction of rotation

Press the key   to switch on or turn off the aperture.

Press the key  , adjust the focus manually

Press the key  , manually adjust the zoom

1.2 RS485/RS232 control





Operation instructions please refer to “3.3.1 PTZ (1) PTZ control parameters setting”

(2) Coaxial camera menu setting

Click “Coaxitron” and select “camera menu”, can open the dome menu



Input calling dome camera menu address code, click “OK”, then press key button “” or click

screen icon “”



Press arrow keys    to set

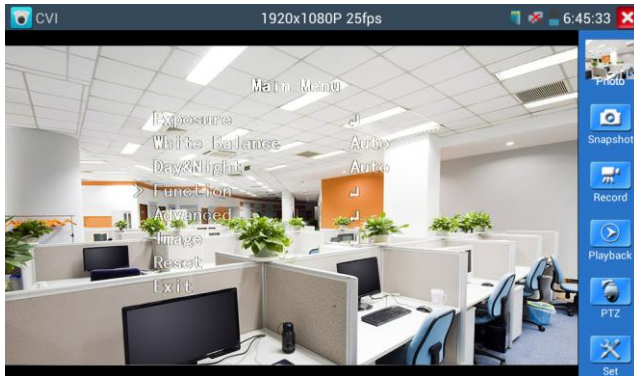

(3)Snapshot, record, photo viewer and video playback, please refer to “3.3.1 Video monitor test”

(4)Save setting

Click icon “Set” on the right toolbar to enter storage setting.

Support auto-storage and manual storage.

When select manual storage, user can name and store the files.



3.3.7 TVI camera test (* Optional)

HD TVI camera, TVI dome camera test and PTZ control, Click icon  to enter

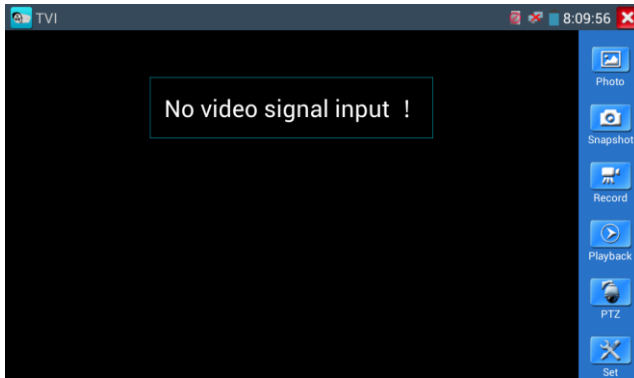

When HD TVI signals input, tester will display the image's resolution on the top bar.

Double-taps on the screen to make the image displayed full screen.

The tester supports resolution as follows:

1280x720P 25FPS / 1280x720P30FPS / 1280x720P 50FPS / 1280x720P 60FPS

1920x1080P 25FPS / 1920x1080P 30FPS / 1920x1080P 50FPS / 1920x1080P 60FPS

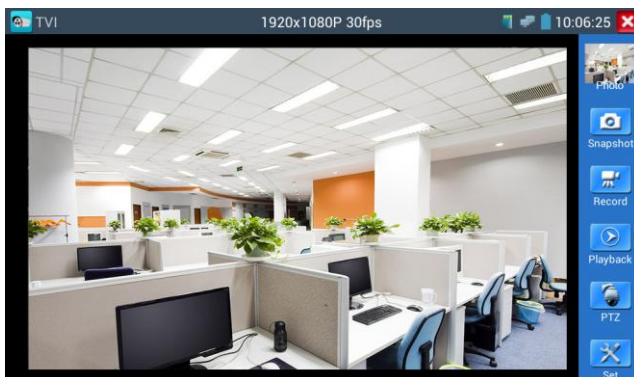

More operation instructions (such as PTZ control, coaxial camera menu setting, snapshot, recording and playback etc), please refer to "3.3.6 CVI camera test"

3.3.8 AHD camera test (* Optional)

AHD camera, AHD dome camera test and PTZ control, Click icon  to enter

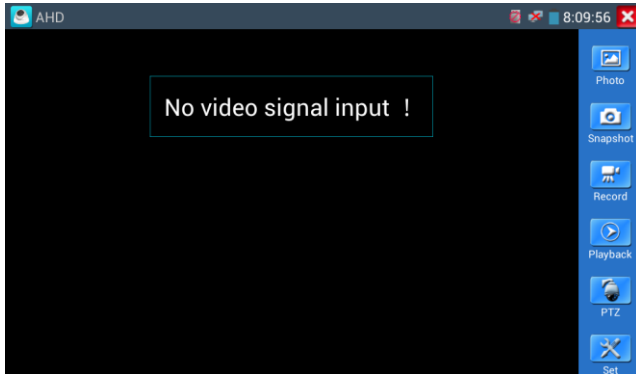

When AHD signals input, tester will display the image's resolution on the top bar.

Double-taps on the screen to make the image displayed full screen.

The tester supports resolution as follows:

1280x720P 25FPS / 1280x720P 30FPS / 1920x1080P 25FPS / 1920x1080P 30FPS

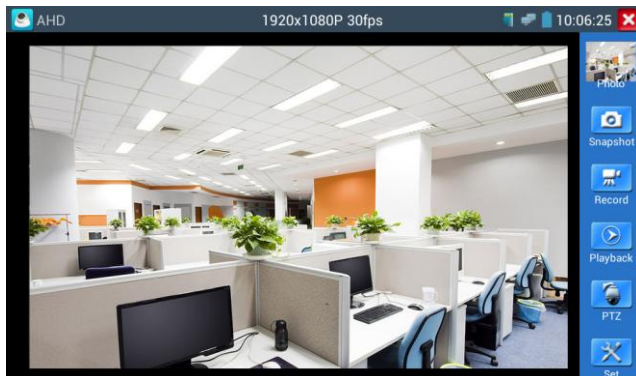

Coaxial PTZ control

Click the icon "PTZ" on the right toolbar to do the corresponding setting.

"Port": Select coaxial control

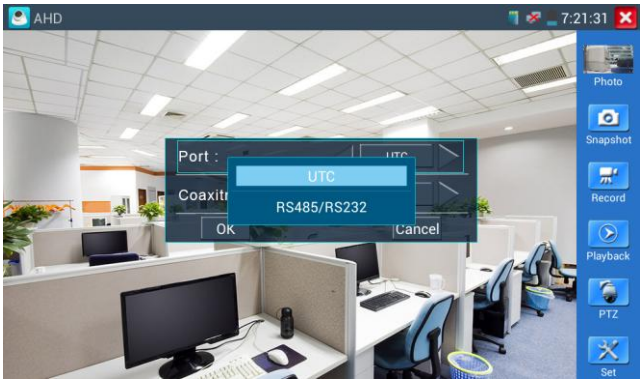

Enter PTZ address to perform parameters setting

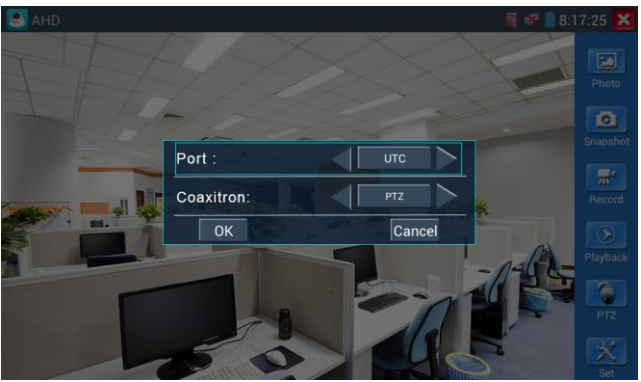

If to coaxial PTZ control the AHD camera, no parameters setting is needed.

More operation instructions, please refer to “3.3.6 CVI camera test”

3.3.9 IP address scan

Connect the cable to the LAN port, click icon  to enter, Set your IP address search range by changing the Start and End IP addresses. Click the “Start” button to scan the IP address range. You can also input an IP address in the Port Number Scan to scan for open ports.

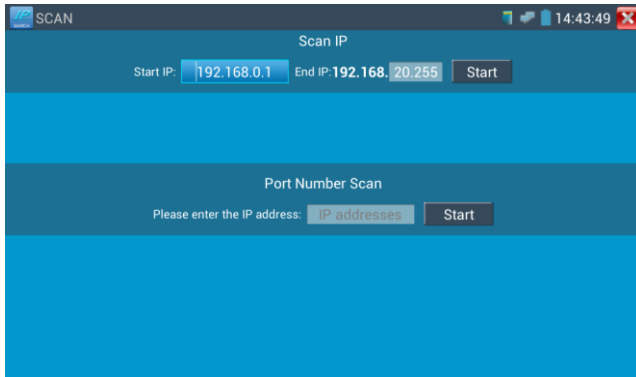

3.3.10 PING Test

PING is the most conventional network debugging tool; it is used for testing if the connected IP camera or other network equipment’s Ethernet port is working normally and the IP address is correct. Connect a network cable to the LAN port and click the  icon to open the PING tool. You can set your LOCAL (native) IP address, Remote IP address (e.g. IP camera), Packet count, Packet Size, Packet time and Timeout. Press “Start” to start pinging. If the IP camera or network device is not configured properly or not plugged in, it will say “Destination host unreachable,” or have 100% packet loss. If the tester connects to the device, the send and receive packets will have a 0% packet loss.

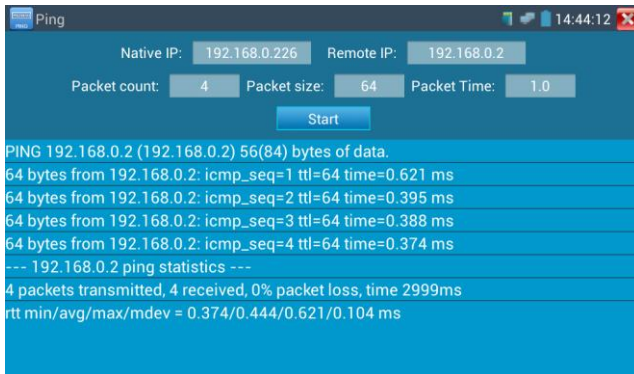

Application: PING testing is the most conventional network debugging tools. It is used for testing if the connected IP camera or other network equipment's Ethernet port is working normally and the IP address is correct.

It's normal that the first data packet will be lost when test start.

3.3.11 Cable test

Click icon  to enter

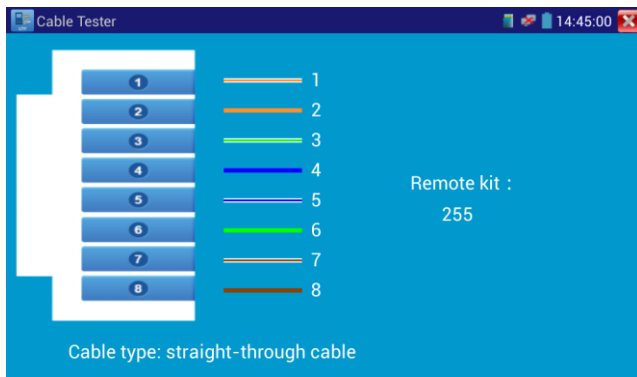

Test LAN cable or telephone cable.

Connect LAN cable or telephone cable with the CCTV tester and cable tester. And then the connecting status, cable type and the sequence of wires as well as the serial number of the cable tester kit will be displayed.

The number of the cable tester is 255

If need several different number other types cable testers, should pay the additional cost.

3.3.12 Cable tracer (* Optional)

Connect test cable or BNC cable to the UTP port or the CABLE SCAN (VIDEO OUT) port on the bottom. Click icon  to enter, click the Number on the screen to adjust audio type.

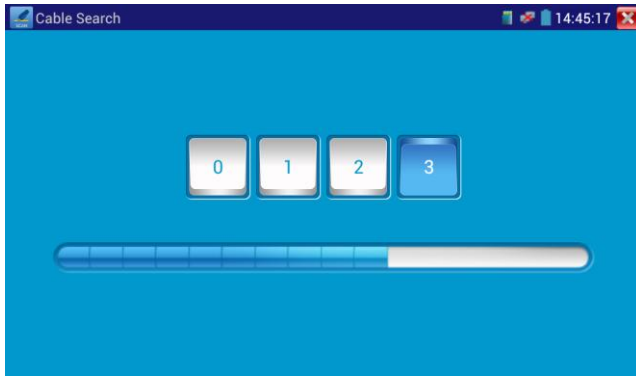

Use the blue Combination cable identifier and network cable tester's copper pointer to touch all the cables in the bundle.

You are searching at the other end. The cable that gives off the loudest tone is the cable connected to the tester. Press the + or – buttons on your blue cable identifier to adjust the volume



Note: Install two AAA batteries in your blue Cable Identifier.



Note: While the cable tracer is receiving the audio signal from the tester, it may be induced into adjacent or crossing cables; however, the cable that makes the loudest noise is the one that's connected to the meter.

Application

It's convenient for people to find out the other end of the cable from the messy cables in security maintenance and network engineering.

While searching BNC cable, connect one port of the alligator clips to the copper core or copper net of the BNC cable, the other one to connect the earth wire (barred windows).



Note: The battery of the cable tracer must according to corresponding positive pole + and negative pole -, otherwise will damage the tester.



Note: While the cable tracer tester is receiving the audio signal from the tester, it may be

influenced by other signals and make some noise.

3.3.13 Port finder

Connect a network cable to the meter's "LAN" port, click the icon  to open the Port Flashing app. Click "Start". The IP tester sends a unique signal to make the connected LAN port of the switch flash.



If the tester and PoE switch are connected well, the LAN port of POE switch flash at special frequency,
If not, no any changes on the LAN port



Application:

The tester will send special signals to make the connected LAN port flicker at special frequency, which will enable the installers to easily and quickly find the connected Ethernet cable. This function can prevent mistakenly insertion or disconnection non-corresponding cable to artificially interrupt network connection.

3.3.14 Data monitor

Pls click icon  to enter

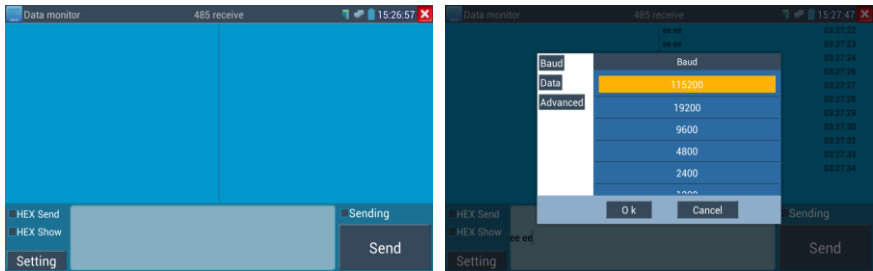

Click “Setting” to choose the baud rate of RS485/RS232; it must be the same as the DVR or the Control keyboard .The DVR or Control keyboard send the code to the tester, if it can be read, the protocol will shown on the upper right, like Pelco D, if not, like P:---

While the tester receives the code, press the  key to empty.

Though the RS485 port, display the PTZ control code of the multifunctional keyboard or the DVR. Controller can check the status of the RS485 transmission through the code on the display. (The RS485 communication rate must be the same.)

Application: Check the RS485 communication states of the video optical transmitter whether normal. Engineer can analyze the protocol and check the data through the displayed code.

3.3.15 Optical power meter (* Optional)

Click icon  to enter ,with five wavelength 1625nm,1550nm, 1490nm , 1310nm ,1300nm ,850nm ,linear or nonlinear optical power display, both for optical power testing and Fiber link loss relative measurement . It is necessary tools for installation and maintenance optical fiber

communication, cable television and CCTV security system.



Note: Please keep the fiber connector and the dust cap be clean, and clean the detector with the special alcohol.

Data hold

While testing, click “Hold” to data hold, the data will not change. It’s convenient to read. Press again to quit.



Relative power value (optical link loss) measurement

While testing, set the wavelength for measurement. Click “relative” (difference) to test, the tester Auto save current fiber power value as the base reference value. Input another optical fiber to be measured, the displayed new measurement and relative value is red color. Press it again to quit.

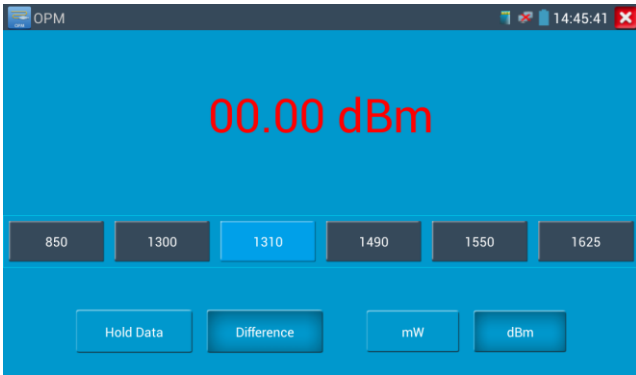

Data hold and Relative measuring use together, the data is yellow while the function is effect.



3.3.16 Visual Fault Locator (* Optional)

Click icon  to enter

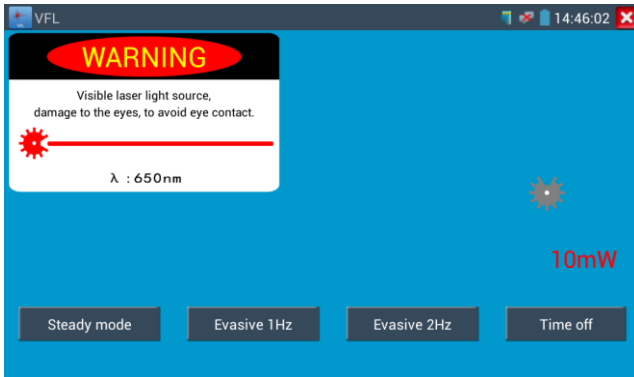

VFL four status can select——“Steady mode”, “Evasive 1Hz”, “Evasive 2Hz”and“Time off”. Click button “Steady mode” to enter steady status, click button “Evasive 1Hz” and “Evasive 2Hz, to enter pulse mode, click button “Time off”, VFL be turned off. Timed turn off can select (5mins, 10mins, 30mins, 60mins and 120mins).

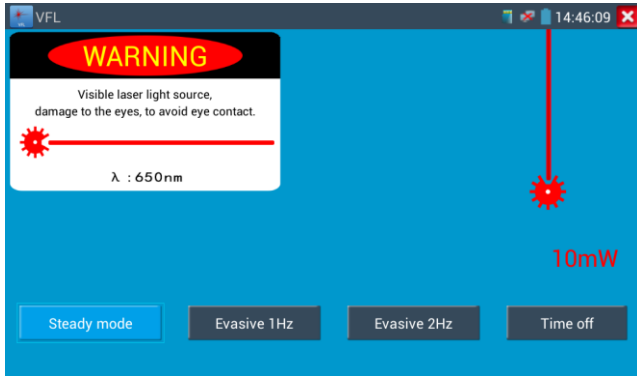

Click "Steady mode", red laser sources emit steady, click again to quit.

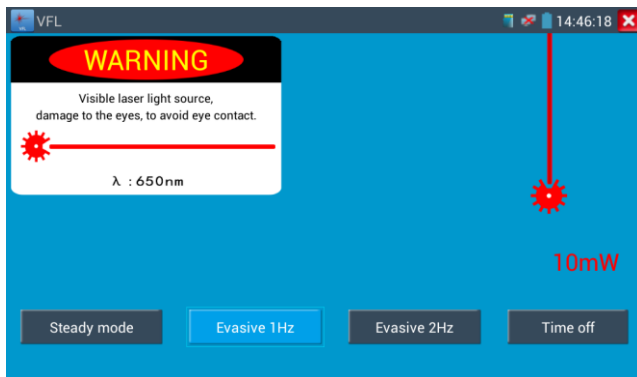

Click icons "Evasive 1Hz" or "Evasive 2Hz" to enter pulse mode, the red laser sources emitted by a certain frequency, press it again to quit

3.3.17 Digital Multi-meter (* Optional)

1. Click icon  to enter

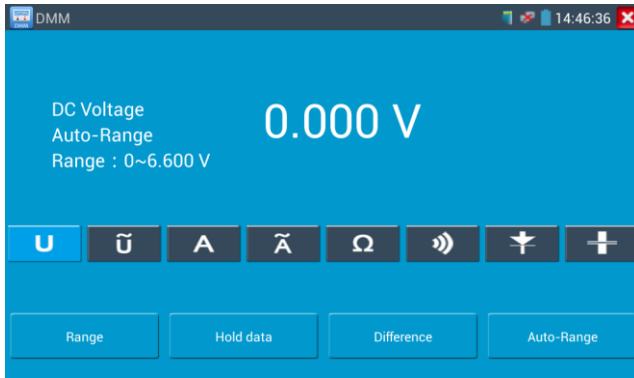

2) SYMBOLS:

U:DC Voltage Measuring

A:DC Current Measuring

Ω:Resistance Measuring

⚡:Diode Testing

U~: AC Voltage Measuring

A~: AC Current Measuring

))) :Continuity Testing

⊕:Capacitance Measuring

AC/DC	Voltage and current measurement state display
Auto- range	The Multimeter auto adjust the range by input signal or tested components
Data hold	Hold data
Relative measurement	Display the relative measurement value Press the key to change display state
10A socket	In 10A current measurement state ,indicate use 10A socket
Over range	The current measurement value over the range, if in the Auto range state, to switch Auto.

(3)OPERATING INSTRUCTION

DC Voltage Measuring

- a. Connect the black test lead to the “COM ” jack and the red test lead to the “V/Ω” jack.
- b. Select U, enter the DC voltage measurement.
- c. the tester default Auto range status ,by click “DC auto range”, press the key can select manual range and restore auto range .

Manual range: 0.000V → 6.600V range
00.00V → 66.00V range
000.0V → 660.0V range
000.0mV → 660.0mV rang

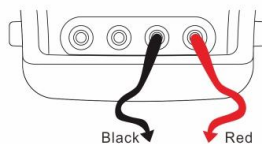

AC Voltage Measuring

- a. Connect the black test lead to the “COM” jack and the red test lead to the “V/Ω” jack.
- b. select U ~ , enter the AC voltage measurement.
- C.the tester default Auto range status, by click “AC auto range”
- d. Manual range can be select , press the key “NEAR” to restore Auto range
- e. Manual range: 0.000V → 6.600V range
00.00V → 66.00V range
000.0V → 660.0V range
000.0mV → 660.0mV range

DC Current Measuring (only manual range)



Shut down the power of the tested circuit, and then connect the meter with the circuit for measurement.

- a. Connect the black test lead to the “COM ” jack and the red test lead to the “mA” jack for a maximum of 660mA current. For a maximum of 10A, move the red lead to the 10A jack.
- b. select A, enter the DC current measurement,the screen display“DC current ”,can select manual range;

c. Manual range: 0.000mA → 6.6mA range
00.00mA → 66.00mA range

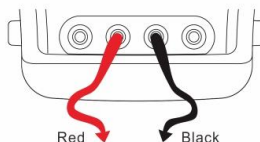

000.0mA → 660.0mA range

00.00A → 10.00A range (use 10A socket)

d. Select the range to enter current measurement



Note:

- ◆ When only the figure “OL” is displayed, it indicates over range situation and the higher range has to be selected.
- ◆ When the value scale to be measured is unknown beforehand, set the range selector at the highest position.
- ◆ The maximum current of mA socket is 660mA; over-current will destroy the fuse, and will damage the meter.
- ◆ The maximum current of 10A socket is 10A, over-current will destroy the meter, and will damage the operator.
- ◆ In “ AC ” mode, only can input “AC”, if not, will damage the meter.

Resistance Measuring



WARNING!

When measuring in-circuit resistance, be sure the circuit under test has all power removed and that all capacitors have discharged fully.

a. Connect the black test lead to the “COM ” jack and the red test lead to the “V/Ω” jack.

b. to select Ω, enter the Ω measurement

the tester default Auto range status, Press the key manually select range ,Press “NEAR” to restore “Auto range”

Manual range:(Connect the red lead to black leads, will display the measure range)

- 000.0Ω → 660Ω range
- 0.000 KΩ → 6.600KΩ range
- 00.00 KΩ → 66.00KΩ range
- 000.0 KΩ → 660.0KΩ range
- 0.000 MΩ → 6.600MΩ range
- 00.00 MΩ → 66.00MΩ rang

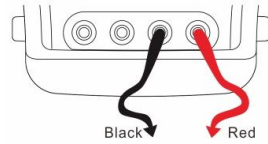

Continuity Testing

- a. Connect the black test lead to the “COM” jack and the red test lead to the “V/Ω” jack.
- b. to select Ⓜ , enter the continuity test, Connect test leads across two point of the circuit under testing.
- c. If continuity exists (i.e., resistance less than about 50Ω), built-in buzzer will sound.

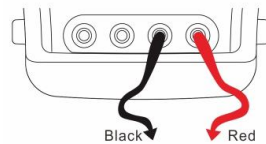

Diode Testing

- a. Connect the black test lead to the “COM” jack and the red test lead to the “V/Ω” jack. (the red lead anode “+”)
- b. to select Ⓜ , enter the diode testing.
- c. Connect test red lead across to the anode, the black lead to the cathode of the diode under testing.
- d. Connect test red lead across to the cathode, the black lead to the anode of the diode under testing.
- e. Tested diode,forward voltage low 30mv,there is sound indication ,then can finish the testing quickly without view the screen.

Capacitance Measuring

- a. Connect the black test lead to the“ COM ” jack and the red test lead to the “V/Ω ” jack.
- b. Select Ⓜ to enter, enter the capacitance measurement.
- c. The tester default auto range status, and manual range by press upward and downward key, Auto rang by press the key “NEAR”

- Manual range: 0.000nF → 6.600nF range
- 00.00nF → 66.00nF range
- 000.0nF → 660.0nF range
- 0.000uF → 6.600μF range
- 00.00uF → 66.00μF range
- 000.0uF → 660.0μF range
- 0.000mF → 6.600mF range
- 00.00mF → 66.00mF range

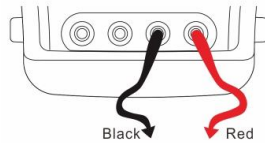

d. Before connect test leads across two sides of the capacitor under measurement, be sure that the capacitor has been discharged fully.



Note:

- The capacitance of a capacitor should be tested separately, should not test in the installation of circuit.
- To avoid electric shock, be sure the capacitors have been discharged fully before measuring the capacitance of a capacitor.
- While testing the capacitance of a capacitor to 660uF, the Max time will be 6.6 seconds, if the capacitor is leaked or damaged, the data can't be read. The tester will be normal after disconnecting the capacitor.

Manual range and Auto range

When testing, click "Range select " to change the value,click "Auto range "to enter Auto measurement

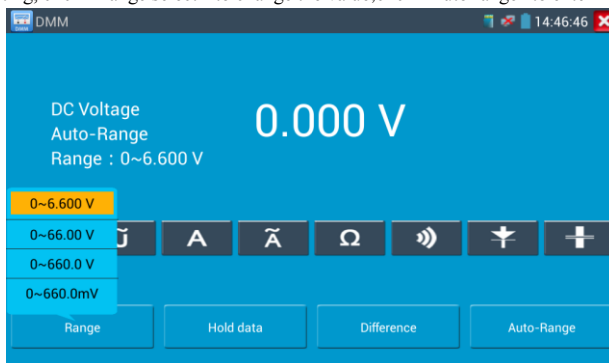

Data hold

Click “Hold data” to enter, the data be hold, the value is green. Press it again to quit.

Relative value measurement

Click “Relative “to enter ,the tester Auto-save the data, the displayed new measurement and relative value is red color. Press it again to quit

The hold function and the relative value be combined use, the display value is yellow

The meter protection

➤ Voltage protection

You can't input the voltage which more than 660V AC, it's possible to show higher voltage, but it's may destroy the inner circuit.

➤ Resistance,Continuity,Diode,PTC component Protection

Wrong input voltage,will Auto enter protection state , It only suitable for short and limit time work.
If input voltage over 600V, will damage the meter.

➤ mA current fuse range :250V 1A

if the current over the rated range ,fuse will melt to protect the meter .Pls use the same model when change the fuse, Pls opens the battery cover to change.



Note: 10A socket without fuse protection, if over the current range

Wrong using the 10A socket to measure the voltage, will damage the meter.

3.3.18 Media Player

Click the icon  to enter

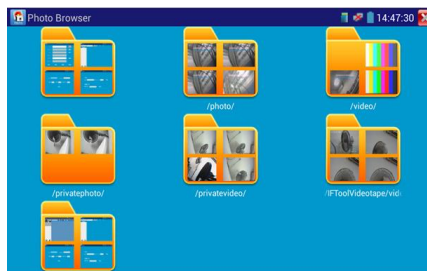

The Media player can browse video and image files. It supports the video formats of MP4, H.264, MPEG4, and MKV. The IP tester recorded files can play directly via the Media player. The Media player will automatically display the video files from the SD card. Click on the desired file to play. Click RETURN to exit.

To rename or delete an existing file, press the file name for a few seconds until the screen below appears. You can then rename or delete the file by pressing the desired option.

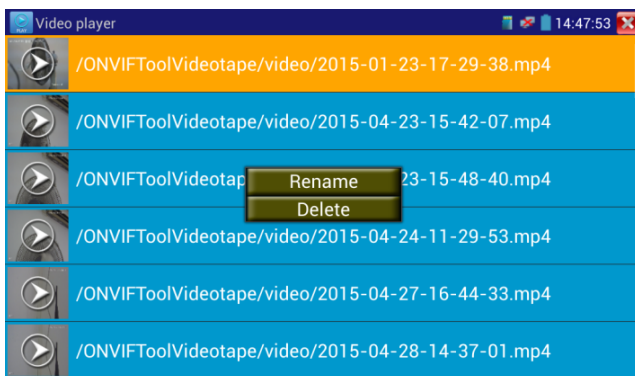

3.3.19 Audio player

Click the icon  to enter , the audio player only supports MP3 format Audio files .



3.3.20 LED Flashlight

It is convenient for the installation or maintenance in the evening or in the dark. Click icon  to enter

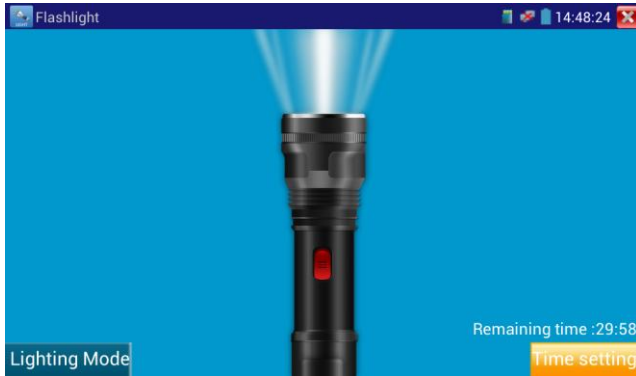

While in the flashlight app, click the red button to turn on the LED lamp. Press it again to turn it off. If you don't press the red button  to shut off the lamp and press the button to exit the app, the lamp will stay on. Click the Time Setting button to set a timer that will shut off the lamp.

3.3.21 PoE/PSE Voltage test

Click icon  to enter PoE voltage measurement

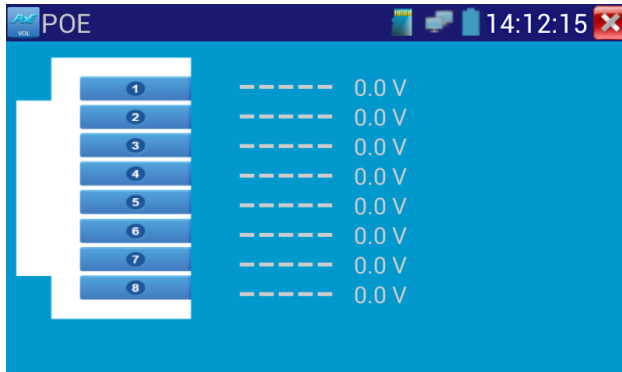

Connect a network cable from a PoE switch to the IP tester 's PSE IN port. Connect an IP camera or other PoE using node to IP tester's LAN port, the PoE voltage and the cable's pin connection status show on the screen.



Note: This test is for measuring the voltage being drawn by the PoE node and the IP tester must be between the PoE switch and the PoE node for this test to work.



Note: The PoE switch must be connected to the PSE IN port. The powered device such as IP camera or other PoE node must be connected to the LAN port.



Note: Do not connect PoE power supply equipment (such as a PoE switch) to the tester's UTP/SCAN port; otherwise it will damage the tester.

3.3.22 TDR cable test (* Optional)



Note: The testing cable can't be connected to any equipment, otherwise it will damage the tester!

Connect Alligator clip cable to the TDR port, and the cable must connect well before testing, or it will influence the accuracy. Click  to enter, and click "Start" to test



Built-in BNC cable, network cable, RVV control cable, Telephone line and TVVB cable etc can test. 11

groups user-defined cable can be set.

Click “cable” “type” to select cable and start testing, One tap on “Start” , do one testing, select built in cable type for testing, click “+” and “-” to adjust cable’s wave speed .



User-defined calibration: Choose the cable 100 meters to 200 meters (more than 50 meters) ,click“Cable” , “Type”to select user-defined 1 for calibration, 11 groups user-defined can be set.



1. Select user-defined and click “Calibration” to enter test , click “user-defined 1” can define cable name, such as: AiPu BNC-5

2. Click “Cable” , “Type” to select cable, and corresponding type, for example, if testing BNC cable, select “BNC”, if testing communication cable 75-2, select SYV 75-2.

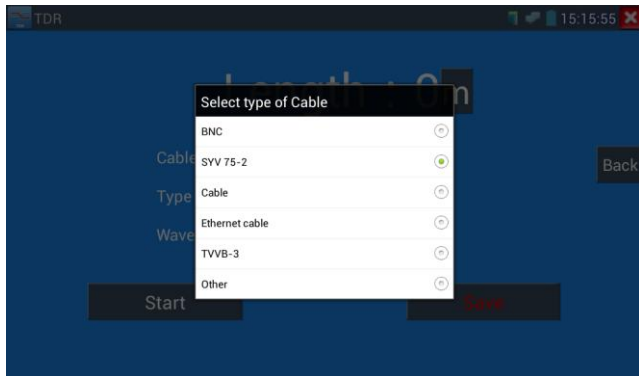

3. Click “+”or“-” to adjust wave speed ,while display length is the same with the actual Length ,click “Save”to save calibration data ,It can be used for the same cable testing next time.

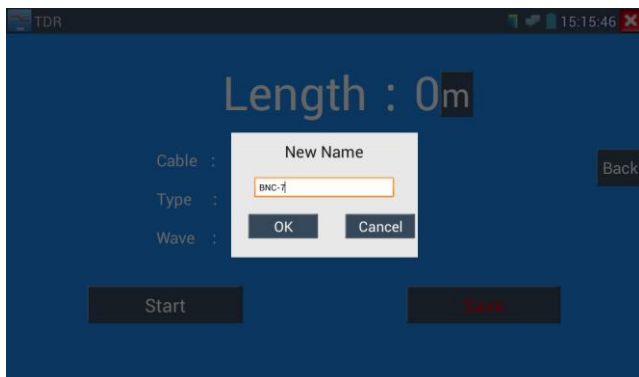

Application:TDR test is the use of pulse reflection method, to transmit pulse signal for tested cable, when cable is disconnected or short-circuit, reflected pulse is generated, the tester receives and deals with the reflected wave, measurement results displayed on the screen. TDR cable test can test cable length and short circuit, help engineer quickly find the cable’s problem location. It is more convenient and efficient to repair the faulty cable.



Note: The TDR reflect signal could be affected by the cable quality/ cable's not well connected etc to cause the different TDR measurement. The TDR measurement is for reference only.

3.3.23 Calculator

Click icon  to enter

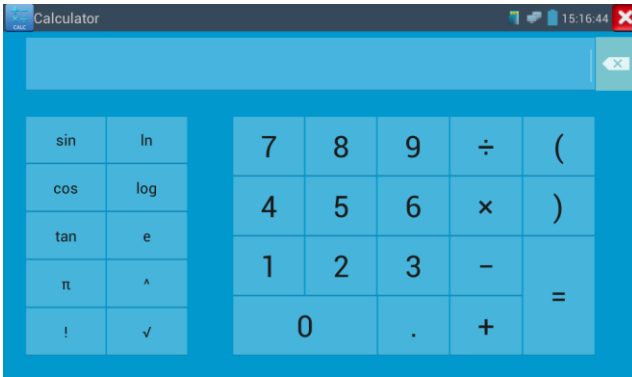



3.3.24 Browser

Click icon  to enter

Type in the camera's IP address and press "Go" to access the IP camera's interface.

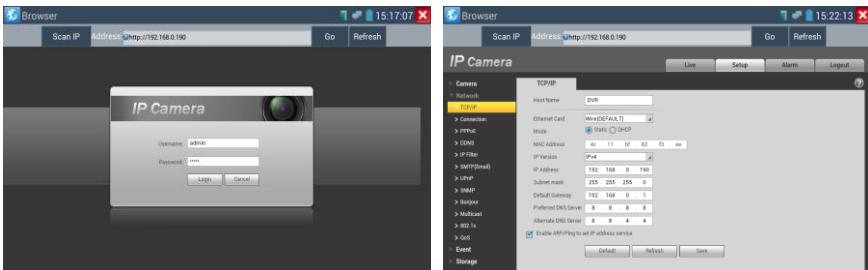
NOTE: You will not be able to view live video in the web browser. For viewing video, use the IP tester's live camera view Apps



The IP camera and IP tester be on the same network segment for the browser to interface with the camera.If they are not in the same segment, click the button  or press “RETRUN” to exit. Open the “Settings” app from the main menu to change the IP tester’s network settings to match those of the IP camera.

3.3.25 IP camera viewer

In addition to the ONVIF app or the IPC Test app, you can use one of the mobile apps in the IPC Viewer folder to view IP camera video. If you cannot find your desired mobile apps, you can send us the mobile apps (Android version. APK files) for our engineers to install in the tester, if successfully installed, the tester will allow you to see the IP camera image by IP camera viewer.

Click icon "IP camera viewer" to enter, run and set the mobile apps parameter to see the corresponding IP camera’s image.

Mobile apps displays IP camera’s image by software decompression, hereby the image may be not clear or fluent.

Note: The mobile apps are third party applications. We do not support these apps or make any usage claims. We do not assume any legal liability.



Click desktop icon several seconds, to uninstall this application

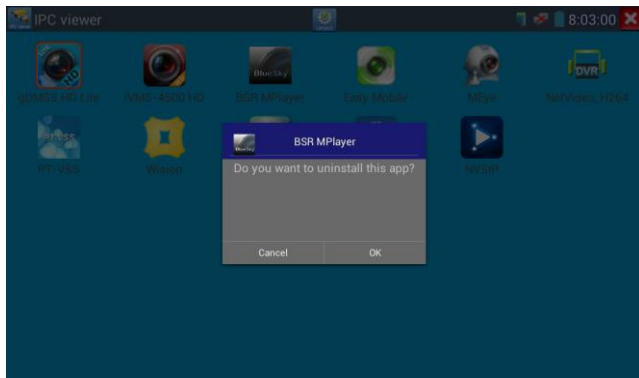

Click icon “update “ in the IPC viewer interface, to update mobile apps.

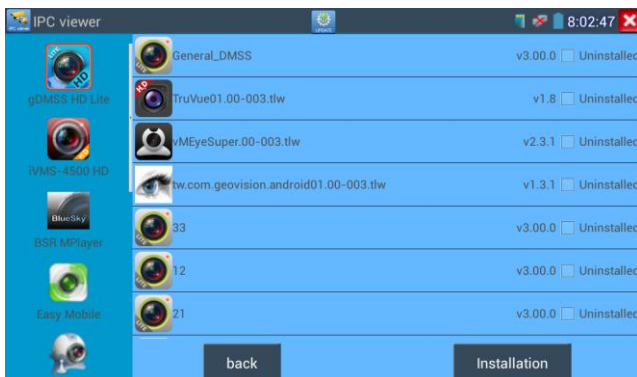

3.3.26 PoE power / DC12V 2A and DC 5V 2A USB power output

When the tester is turned on, the 12VDC and 5VDC power output functions are automatically turned on.

If the IP tester is turned off, the 5VDC USB can still be used to power an external USB device.

To use the PoE Power Output function, click on the icon  and change the switch “ON” or “OFF”. The IP camera needs to be connected to the LAN port before you turn PoE Power on. If the IP camera supports PoE, the PoE power is delivered via pins 1, 2, 3, and 6 on the LAN port. The IP tester will display “48V ON” at the top of the screen when the POE power is still on.



 Note:

1. Don't input power into the "DC12V/2A OUTPUT" port.
2. Don't output this DC12V/2A power to the DC12V/IN port of the IP camera tester to avoid destroy
3. The IPC tester power output is close to 2A, if the IP camera's power is over 2V, the tester will auto enter protection mode. Disconnect all the connections of the tester and then connect the tester with

power adaptor to resume the tester.

4. Before turning on the PoE power output, please make sure the IP camera supports PoE power.

Otherwise it may damage the IP camera.

5 Make sure you plug in your IP camera to the LAN port prior to turning on PoE power

6. Make sure the tester is full charged or more than 80% charged, otherwise the tester will shows “low power”, “not able to supply power” .

3.3.27 Application tools

Click the icon  to open the Application Tools folder. This folder contains useful apps such as Audio Recording, DHCP Server, Network test, Notepad, Link monitor and RTSP Player.

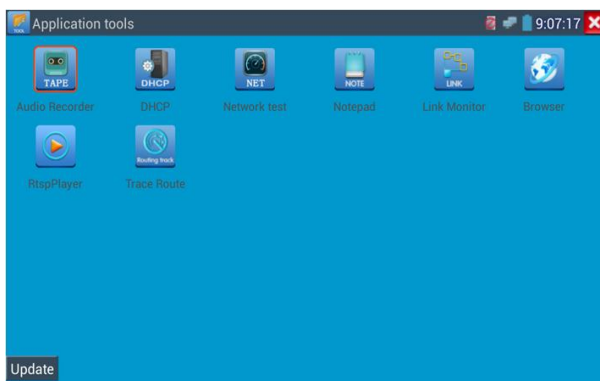

Audio Record: Connect an audio device to the IP tester’s audio input port. Click the  icon to enter the Audio Recorder app. Click the red button to stop, and the unit will prompt you to save the recording

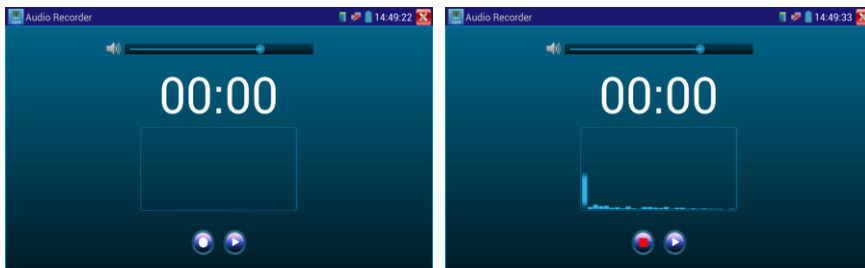

Network test (Ethernet bandwidth test)

To use the Network tester, you will need two IP testers. One is used as a Server and the other as a Client. Both devices must be on the same network segment in order to communicate. Click icon  to open the Network Tester app.

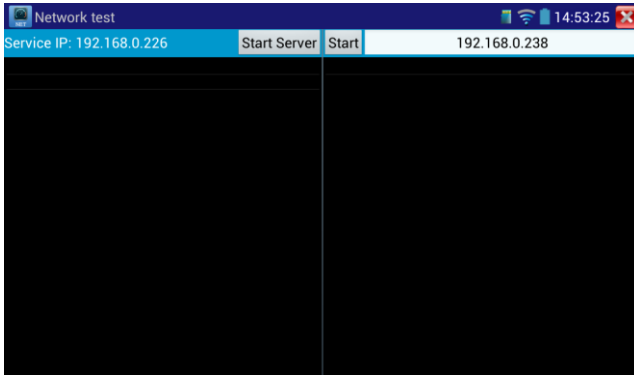

When test, need a tester or a computer installed Network Test Software as the Server, the other tester sends packet test. The two testers must be in the same network segment.

a).Start the server: Click “Start Server” button to use the tester as a Server. It will display its IP address at the top of the screen.

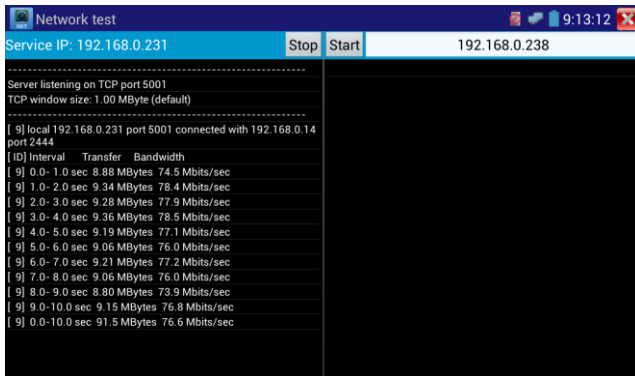

b).Start send packet test: Using the other IP tester, and type in the Server's IP address at the top right corner of the screen. This app is used to send packets for network speed testing. Click the “Start” button to send the packets and start testing.

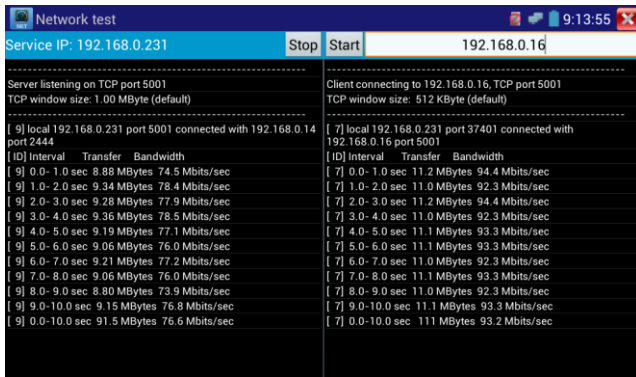

Network bandwidth testing can also be tested with a computer using compatible network bandwidth testing software. Install network bandwidth testing software on a computer, as a test Client or Server, to do the mutual testing with the tester. If use computer as the server, the computer IP address is:

192.168.0.89



Tester as Client, tester’s IP address is:192.168.0.230. The Server and the Client are at the same network segment, but with different IP address. Input Server’s IP address 192.168.0.89 in the tester and click

“Start” to test network bandwidth.

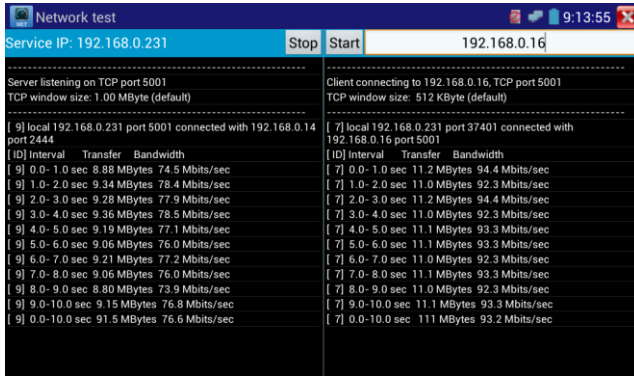

Or tester as a Server, computer as test Client (select Client,input tester’s IP address to test)

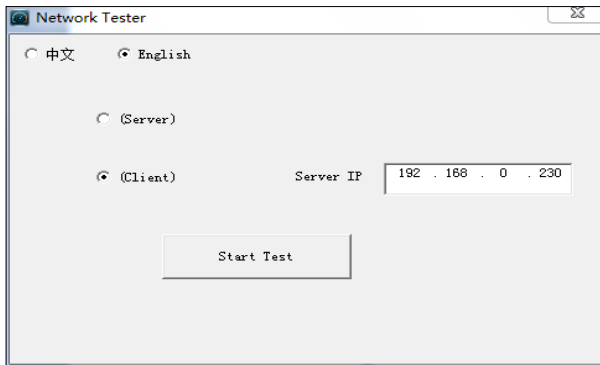

When tester as server, shows results:

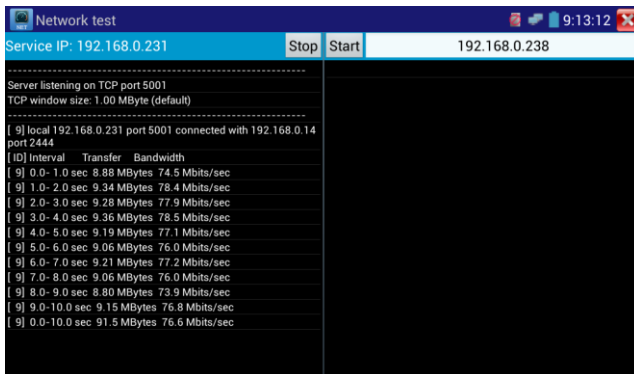

DHCP server:

Click on the DHCP icon to open the DHCP server app. Select the “Start” check box at the top and make any desired changes to the network settings. Click “Save” to start assigning dynamic IP addresses for IP cameras and other networked devices. Click the “Refresh” button to check your Client list.

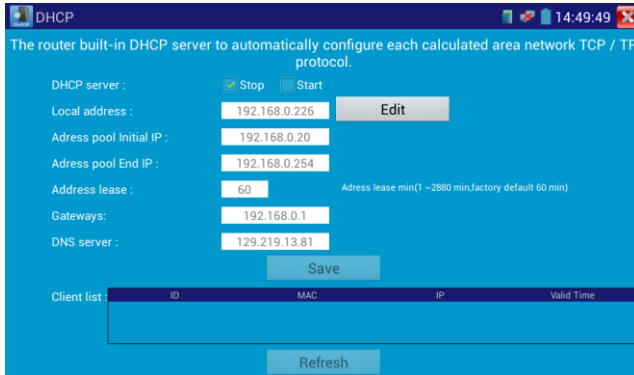

Notepad:

NotePad can be used to record the important testing results, click the key “Save” to save the contents. NotePad can auto record the storage date and time.

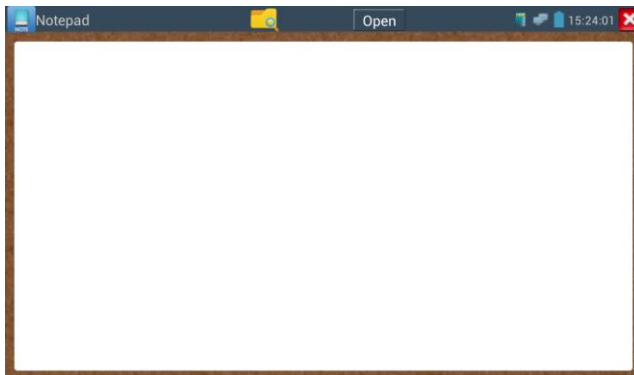

Please click  to view the notepad, all saving contents display. Click each record bar to show the details. Press the record bar for several seconds, prompt whether delete it

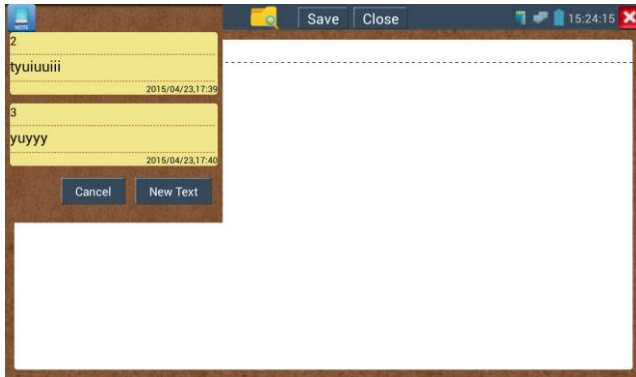

Link monitor :

Click the  icon to open the Link Monitor app. This app is used to see if an IP address is occupied by other network devices. This will avoid new address conflicts

Click “Add” and enter the desired IP address. To test different network segments, click the “Settings” icon on the main menu and go to IP Settings and make the desired changes. Once the desired IP addresses are added to the Link Monitor list, click “Start”. If the IP address status shows a check mark the IP address is occupied. If the IP address status shows an X the IP address is available. Click “Stop” to stop the testing

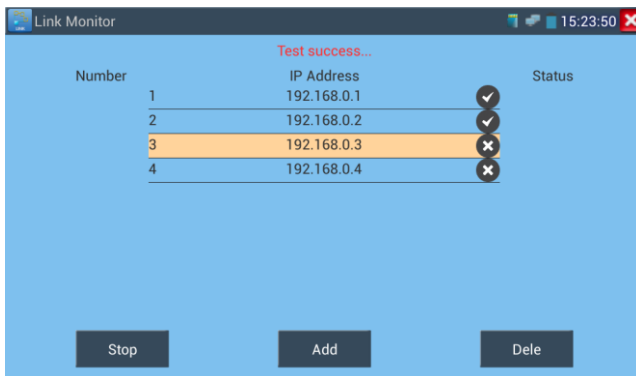

Application:

Add an IP camera or other network device to the current network group, the new IP address must not be occupied, otherwise it will cause IP conflicts and stop the equipment normal working. Link monitor can check if the new setting IP address is occupied.

RTSP Player :

The RTSP Player app will allow you to view the RTSP video stream from an IP camera. If you were unable to view your camera via the ONVIF or IPC Test apps, it is possible your camera will have an RTSP stream and you can view live video.

From the main menu, select the “APP Tool” folder and then select the “RTSP Player” to open the app. If the IP camera uses MJPEG, select the RTSP icon. If the IP camera uses H.264, select the “RTSP HD” icon.

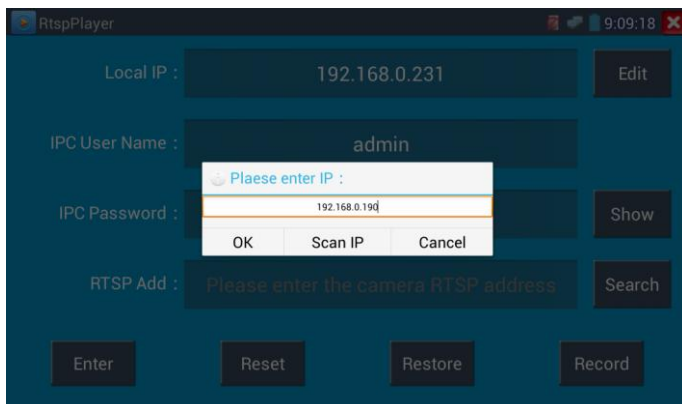

Local IP: This is the IP testers IP address.

RTSP Add: This is where you can manually enter the IP camera’s RTSP URL or click on Search to search the network for cameras that use an RTSP stream.

IPC Username: Enter the IP camera’s user name.

IPC Password: Enter the IP camera’s password.

Once you have entered all the necessary information, select Enter at the bottom left to view the RTSP stream.

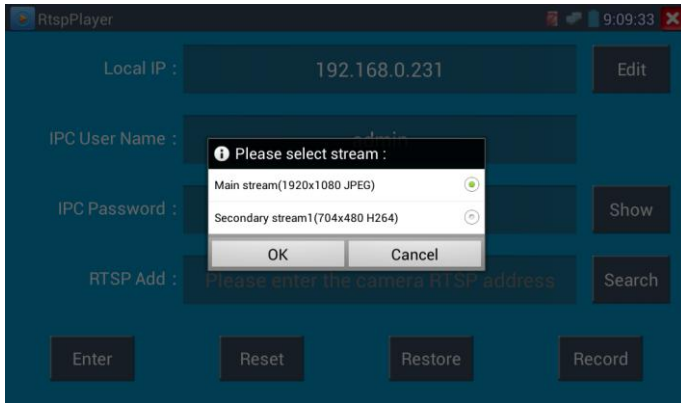

Note: in the event the ip tester does not auto detect the rtsp stream, refer to the specific camera manufacturer for the specific rtsp stream url. you may find this on line with a search of the camera model number and the word rtsp

Trace route

Trace route is used to determine path of the IP packet access target.

Note: Trace route testing results only for reference, for accurate test route tracking, Please use professional Ethernet tester.

Click  to enter Trace Route

Input tracking IP address or domain name in the Remote Host IP. Set maximum hop count, normally default is 30

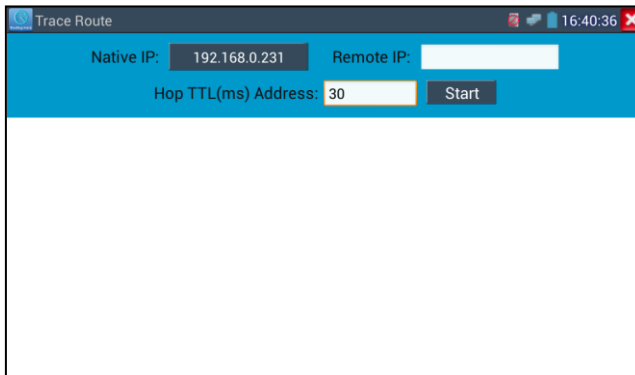

Click “start” to trace the goal address

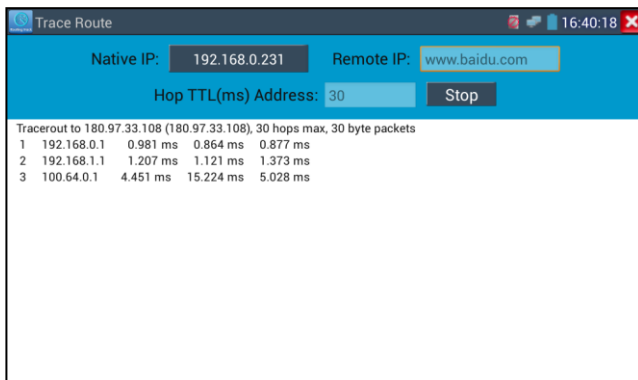

3.3.28 APPS Tools Folder

Click icon  to enter

You can move desktop icons into the Tools Folder by pressing on the icon for a few seconds until the screen below appears:



You can also move an icon back to the desktop by pressing on the icon for a few seconds until it asks you if you want to move the icon back to the desktop

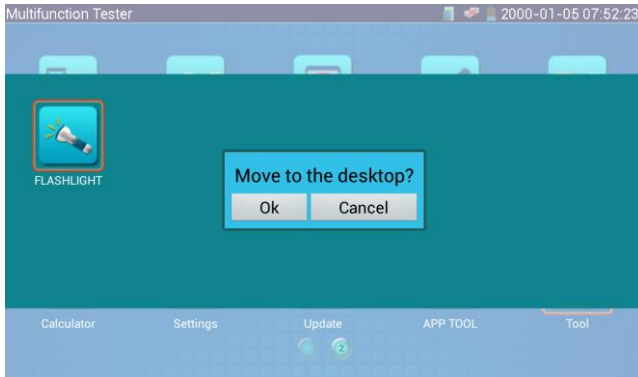

3.3.29 System Setting

Click icon  to enter



Language: Select your desired language: English, Chinese, Korean, Russian, Italian or Polish.

Date/Time: Set the Date/time of the IP tester

IP setting: Manually set the IP address, Subnet Mask, Default Gateway and DNS address or select “Dynamic allocation” to use DHCP. To test multiple network segments, click “Advanced” and then click “Add” to enter another IP address for the IP tester

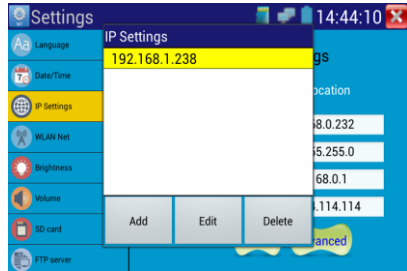
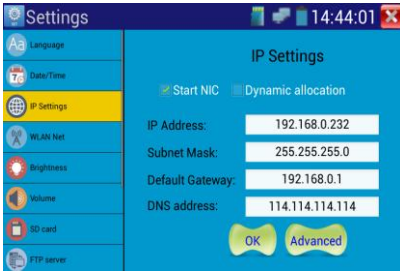

After setting an advanced IP address (refer to above photos), the tester can test two network segments (192.168.0.0) and (192.168.1.0).

WLAN Net: Turn WiFi off or on by pressing the “Open the wifi” button. Once WiFi is turned on, it will scan for wireless networks in your area. Select the desired wireless network SSID and enter your password to connect.

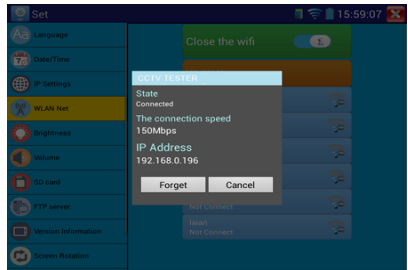

Brightness: Set the desired brightness of the IP tester and adjust the sleep time settings.

Volume: Set volume level

SD Card: Displays SD Card Capacity. You can also format the SD card or unmount it before removing it.

FTP server: Once the IP tester connects to a network, a computer can be used to read the SD card files via FTP

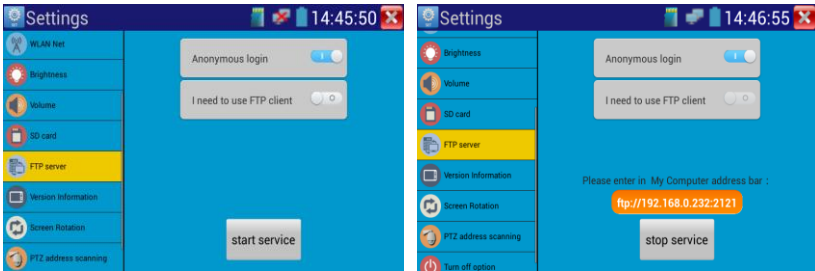

Start the FTP server and then input the tester’s FTP address in the PC’s address bar. This will enable the PC to read, copy and edit the files from the SD card without the use of SD card reader.

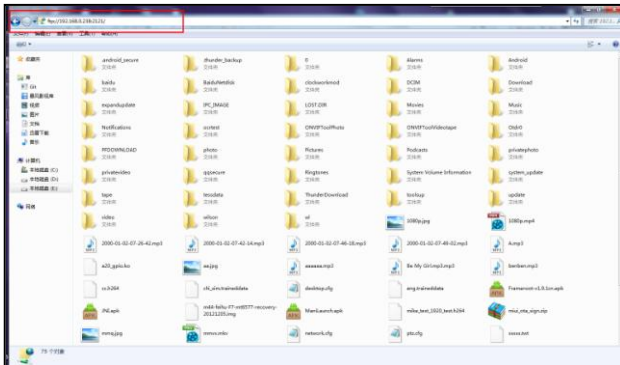

Power display: Display the battery level information

Version information: This displays the version information for each application

Screen display rotation: Click on “Screen Rotation” to flip the IP tester’s display 180 degrees. This function is very convenient for the user to connect the LAN cable on the bottom of the unit without having to flip the unit itself.

PTZ address scan : You can toggle the PTZ Address scan off or on before entering the “PTZ controller” app. This needs to be turned on in order to use the PTZ Scan feature of the PTZ app.

Turn off option: If you select “Fast turn off”, the tester will shut down faster but data will not save. To avoid unnecessary problems, it is recommended not to use the “Fast turn off” option.

3.3.30 Update

Click the  icon to open the Update menu. Select “Local Update” to update via the SD card or select “Online Update” to check for updates on the internet. If there are applications that need updating, the applications will be displayed on the screen. Click the relevant applications to update them to the latest version.

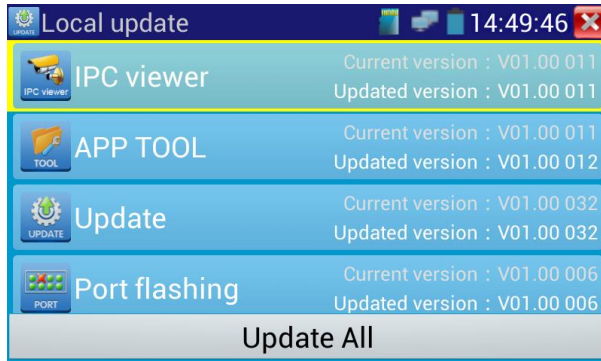

3.4 HDMI output

The built in HDMI output port can output live video from an analog or IP camera, recorded files, media files and images to HDTV monitors. Connect an HDMI cable from the IP tester to an HDTV monitor at any time. It supports up to 1080P resolution.

3.5 PoE power output

The IP tester supports PoE (Power over Ethernet) output to an IP camera via the LAN port. Data transmission and 48VDC use the network cable's 1, 2, 3, and 6 pins to deliver power. If the IP camera supports PoE, you can directly connect to the camera without the use of an external power supply.



⚠ Notice

- a. Please make sure the cable connected to the tester's Lan port is straight-line cable and has no short circuit, otherwise will damage the tester
- b. Before using PoE power output, pls check the IP camera whether supports POE powered. Otherwise it will damage the IP camera.
- c. The instrument's PoE maximum power output is 24W. If Ultra- high-power load happens, the tester will enter protection mode .

3.6 DC12V 2A power output

When the IP tester is turned on, the 12VDC power output ON by default. The smaller end of the supplied converter cable connects to the tester's DC12V/2A OUTPUT and the other end connects to the camera's power input.



Application

Power output function is mainly used in the camera field demonstration and testing, meanwhile, for some camera installation sites, if there is no power outlet for the adapter to power the camera, the tester can offer temporary power for it. But we do not suggest tester supply power for a long time.



Notice:

- a. **Don't input any power into the "DC12/2A OUTPUT" port of the tester**
- b. **Man-made damage is not within our company's warranty**
- c. **The IP tester's power output capacity is 2A. If the IP camera uses more than 2A, the tester will automatically enter a protection mode**
- d. **. Disconnect all cables from the tester and reboot it to resume using the tester.**

The IPC tester power output is close to 2A, if the IP camera's power is over 2V, the tester will auto enter protection mode. Disconnect all the connections of the tester and then connect the tester with power adaptor to resume the tester.

- e. **Make sure the tester has a sufficient charge otherwise the tester will not able to provide enough output power**

3.7 USB 5V 2A power output

When the tester is turned on, the 12V DC and 5V DC power output functions are automatically turned on. If the IP tester is turned off, the 5VDC USB can still be used to power an external USB device.

NOTE: The USB port is for power only and not data.



3.8 Audio test

You can test the audio input from audio pickup devices by connecting the audio pickup device to the IP tester with the supplied audio cable.



4. Specifications

4.1 General Specifications

Model	IP Camera tester 【*】 models Optional
Display	4.3 inch capacitive touch screen , resolution 800 (RGB) x 480
Network port	10/100M auto adapt,RJ45
WIFI	Built in WIFI,speeds150M, allows you to connect to a wireless network and view IP cameras
IP camera type	ONVIF,ONVIF PTZ, Dahua IPC-HFW2100P, Hikvision DS-2CD864-E13, Samsung SNZ-5200, Tiandy TD-NC9200S2, Kodak IPC120L, Honeywell HICC-2300T, RTSP Viewer
SDI video Signal test *(Optional)	1 channel SDI input (BNC interface) , support resolution:720p 60fps / 1080p 30fps /1080i 60fps
CVI video Signal Test * (Optional)	1 channel CVI input (BNC interface) , support resolution:720p 25,30,50,60fps/ 1080p 25,30fps
TVI video Signal Test * (Optional)	1 channel TVI input (BNC interface) , support resolution:720p 25,30,50,60fps/ 1080p 25,30fps
AHD video Signal Test * (Optional)	1 channel AHD input (BNC interface) , support resolution:720p 25,30fps / 1080p 25,30fps
Analog Video test	1 channel BNC Input & 1 channel BNC Output , NTSC/PAL (Auto adapt)
Video level meter * (Optional)	PEAK video signal level, SYNC signal level, COLOR BURST chroma level measurement for cvbs camera
Zoom Image	Supports Analog and IP camera image zooming & movement
Snapshot,Video record and playback	Capture still images and record live video. Media player will view photos and playback video
HDMI output	1 channel HDMI output, supports up to 1080p
PoE power output	48V PoE power output, Max power 24W
12V/2A power output	Output DC12V/2A power for camera

USB 5V power output	5V 2A power output only ,no data
Audio test	1 channel audio signal input and 1 channel audio signal output to connect headphones
PTZ control	Support RS232/RS485 control, Baud 600-115200bps, Compatible with more than 30 protocols such as PELCO-D/P, Samsung, Panasonic, Lilin, Yaan, etc
color bar generator	Output one channel PAL/NTSC color bar video signal for testing monitor or video cable.(red, green ,blue, white and black color)
UTP Cable tester	Test UTP cable connection status and display on the screen. Read the number on the screen
Data monitor	Captures and analyzes the command data from controlling device, also can send hexadecimal
Network test	IP address scan, link scan, and Ping test. Quickly search the for IP camera's IP address on your network
Cable tracer *(Optional)	Find a connected cable from a bundle of cables using audio tones
PoE /PSE voltage test	Measures PoE switch voltage and displays pin configuration
Digital Multi-meter * (Optional)	AC/DC Voltage, AC/DC current, Resistance, Capacitance, Data hold, Relative measurement, Continuity testing . Testing speed: 3 times/ seconds, Data range -6600~+6600.
Optical power meter * (Optional)	Calibrated Wavelength(nm) :850/1300/1310/1490/1550/1625nm Power range(dBm) :-70~+10dBm
Visual fault locator * (Optional)	Test fiber's bending and breakage (SM and MM fiber)
TDR cable test *(Optional)	Cable open circuit and short circuit measurement (BNC cable, Coaxial cable, Cat5/6, telephone cable)
POWER	

External power supply	DC 12V (2A)
Battery	Built-in 7.4V Lithium polymer battery , 5000mAh
Rechargeable	After charging 7~8 hours, normal working time 16 hours
Parameter	
Operation setting	Capacitive touch screen, OSD menu, select your desired language: English, Chinese, Korean, Russian, Italian or Polish, etc
Auto off	5-30 (mins)
General	
Working Temperature	-10°C---+50°C
Working Humidity	30%-90%
Dimension/Weight	215mm x 127mm x 53mm / 0.82kg

Note: * means Optional function

4.2 Multi-meter specifications

Counts:-6600~+6600

Conversion rate: 3times/s

Current modes for clamp meter with ZERO function

Isolation: the Multi-meter connector must be isolated with the other connector.

DC voltage

Range	Accuracy	Resolution
660mV (Manual range)	$\pm (0.3\%+4)$	0.1mV
6.600V		1mV
66.00V		10mV
660.0V		100mV

AC voltage

Range	Accuracy	Resolution
660.0mV (Manual range)	$\pm (1.5\%+6)$	0.1mV
6.600V	$\pm (0.8\%+6)$	1mV
66.00V		10mV
660.0V		100mV

DC current

Range	Accuracy	Resolution
6.600mA	$\pm (0.5\%+3)$	1uA
66.00mA		10uA
660.0mA		100uA
10.00A	$\pm (1\%+5)$	10mA

AC current

Range	Accuracy	Resolution
6.600mA	$\pm (0.5\%+3)$	1uA
66.00mA		10uA
660.0mA		100uA
10.00A	$\pm (1\%+5)$	10mA

Resistance

Range	Accuracy	Resolution
660.0 Ω	$\pm (0.8\%+5)$	0.1 Ω
6.600K Ω	$\pm (0.8\%+2)$	1 Ω
66.00K Ω		10 Ω

660.0K Ω		100 Ω
6.600M Ω		1K Ω
66M Ω	$\pm (1.2\%+5)$	10K Ω

») **Continuity**

Range	Resolution	Function
660.0 Ω	0.1 Ω	The measurement value less 30 Ω \pm 3 Ω ,the tester will sound

Diode

Range	Resolution	Function
2.0V	1mV	Schottky diode:0.15~0.25V rectifier diode:0.6~1.0V triode PN junction:0.5~0.8V

Capacitance

Range	Accuracy	Resolution
6.600nF	$\pm (0.5\%+20)$	1pF
66.00nF	$\pm (3.5\%+8)$	10pF
660.0nF		100pF
6.600 μ F		1nF
66.00 μ F		10nF
660.0 μ F	$\pm (5\%+8)$	100nF
6.600mF		1 μ F
66.00mF		10 μ F

4.3 Optical power meter specifications

Measure Range(dBm)	-70~+10dBm
Wavelength(nm)	850nm,1300nm,1310nm,1490nm,1550nm,1625nm
Detector	InGaAs
Uncertainly	< ±3%dB(-10dBm,22℃) < ±5%dB(full range,22℃)
Display Resolution	Linear:0.1% ; Nonlinear:0.01dBm
Operating Temperature(℃)	-10~+50
Storage Temperature (℃)	-20~+70
Connector type	FC/PC

4.4 Visual fault locator specifications

Laser type	LD
Wavelength Calibration	650nm
Output power	5mW (Optional 10mW,20mW)
Modulation mode	CW/1Hz/2Hz
Measurement Range	5KM (Optional 10-20KM)
Connector	FC/PC exchangeable
Working Temperature	-10℃~+50℃
Operating Temperature	-20℃~+70℃

The data above is only for reference and any change of them will not be informed in advance. For more detailed technical inquiries, please feel free to call the Technical Department of our company.