

Separating transformer

CT-007-048-12-0

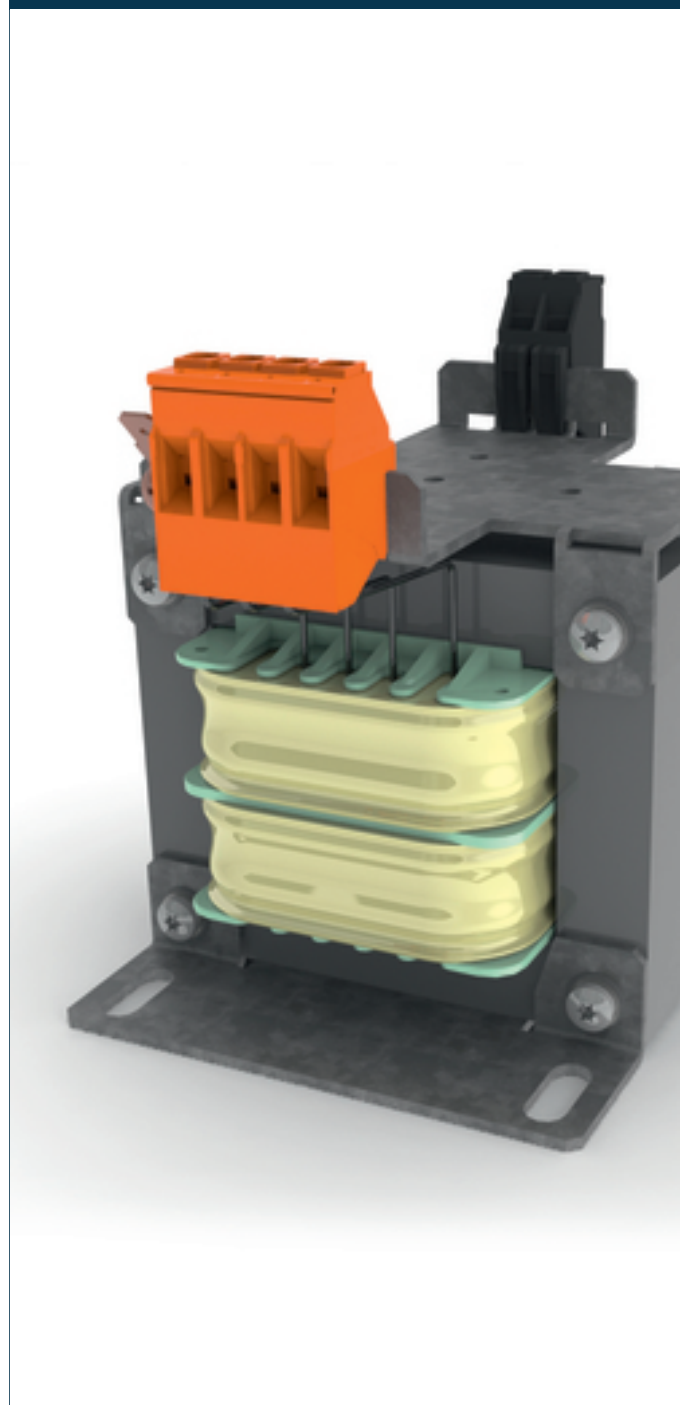

Advantages

Fused versions available

Versions with DIN rail for additional components available

100 % finger-safe

Jumpers included for primary voltage selection

Impregnated for max. protection

Up to 2500 VA

Applications

As an industrial control transformer for adjustment of the voltage and simple electrical isolation.

Sample application

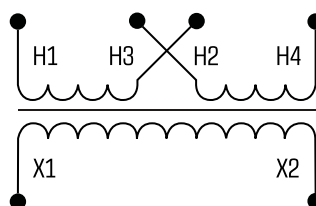

Standards



Separating transformer
to: EN 61558 part 1 with part 2-1, UL 5085-1/-2;2:2, CSA 22.2 No. 66

Approvals



UL 5085-1/-2, CSA 22.2 No.66

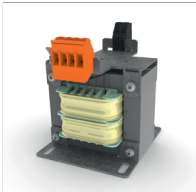

Separating transformer CT-007-048-12-0

Type		CT-007-048-12-0
Electrical data	Special features	
	Characteristics	-
	Input	
	Rated input voltage	240 x 480 Vac
		2 x 0.19 Aac
	Frequency Range	50 - 60 Hz
	Output	
	Rated output voltage	120 Vac
	Power	75 VA
	No-load voltage (app. x factor)	1.16
	Efficiency	82 %
	Standards	
	Classification	Separating transformer
	Approvals	
	Approvals	cURus
	Environment	
	Ambient temperature	max. 104 °F
	Type of cooling	Air natural
	Safety and protection	
Type	Open type	
Insulation class	B, class 130	
Protection index	IP 00	
Safety class (prepared)	I	
Short circuit strength	non-short-circuit proof	
Core	EI 78/27,5	

Type		CT-007-048-12-0
Mechanical data	Measures and weights	
	Weight	2.43 lbs

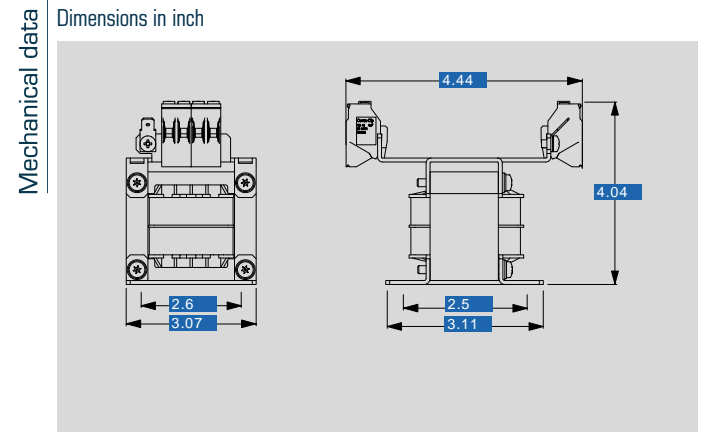

Subject to change.