

TENMA[®]



Pocket Size Digital Multimeter with USB

Model: 72-7730A & 72-7732A









IMPORTANT SAFETY INFORMATION

Please read these instructions carefully before use and retain for future reference.

This instrument is designed & manufactured in compliance with: G84793, IEC61010-1, CAT III 600V, & CAT IV 1000V Pollution Degree 2 and Double Insulation standards.

- Please operate according to this manual, otherwise the protection provided by the device will be impaired or fail.
- Check the test leads, probe and case insulation condition before using. If you find any breakage, damage or abnormality, or you consider the device is broken, stop using the device immediately.
- When using the test probes, keep your fingers behind the finger protection rings.
- Ensure all inputs are less than the range selected otherwise it may cause electrical shock or meter damage.
- Take caution when voltages are above 60V DC and 30V AC rms.
- Disconnect circuit power and discharge all high-voltage capacitors before testing resistance, diode and current.
- Do not use the meter with the back cover removed.
- Do not adjust the range selector during measurement.
- Replace the batteries as soon as the low battery indicator appears on the display.
- Remove dead batteries from the meter or if it is not going to be used for a long time.
- Never mix old and new batteries together, or different types of batteries.
- Never dispose of batteries in a fire, or attempt to recharge ordinary batteries.
- Before replacing the battery, turn off the meter and disconnect all the test probes.
- To prolong battery life turn off the meter after use..

ELECTRICAL SYMBOLS GUIDE

	Low battery		Grounding		Warning
	Double insulated		AC		DC Measurement
	Fuse		Diode		AC/DC Measurement

WHAT'S INCLUDED

- Digital Multimeter with USB.
- 1 pair of test leads.
- Temperature probe.
- Alligator clip.
- Test clip.
- USB interface cable.
- CD Rom PC software.
- Storage bag.
- 9V battery.

OVERVIEW

1. LCD display
2. Function buttons.
3. Range selector.
4. Input terminals.

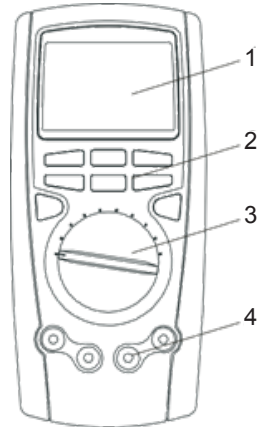

Automatic Power Off

- The display blanks and the meter goes into sleep mode after a 10 minute period of inactivity.
- While in Sleep mode, pressing the blue button or turning the range selector will reactivate the meter.
- The meter then returns to the display for the function selected with the range selector; all previously activated button features are discarded.

Display Backlight

- Press LIGHT button to turn the backlight on and press LIGHT again to turn it off. Press EXIT to exit the feature.
- Press LIGHT to select the backlight level (low or high) in the Setup menu where you could specify a time to automatically turn off the backlight (10 seconds, 20 seconds, 30 seconds or OFF). If the period is set to OFF, the backlight feature is disabled.

RANGE SELECTOR FUNCTIONS



Position	Function	Blue Key function
OFF	Turn the meter off	None
V	DC voltage measurement	None
V~	AC voltage measurement	None
mV	DC millivolt measurement	None
Hz % mV	DC millivolt measurement	Frequency measurement Frequency signal duty cycle
Ω	Resistance measurement	Diode test Continuity test
	Capacitance measurement	None
Hz %	Frequency measurement	Frequency signal duty cycle
°C °F	Centigrade measurement	Fahrenheit measurement
μA~	DC current measurement (400μA, 4000μA)	Switch between DC and AC
μA~ 4-20mA %	DC current measurement (40mA, 400mA)	Switch between AC or DC current 4~20mA loop current as % reading
A~	AC or DC current measurement	Switch between AC and DC





- Press the blue key to access alternate functions of the main range selected.



Function buttons

- The buttons activate features that augment the function selected with the range selector.
- Press the button once to access the main feature (e.g. STORE).
- To access the first additional feature of the button (e.g. RECALL), press and hold the button for over 1 second. This additional feature illuminates above or on the left hand side of the appropriate keys.

Note: The RANGE and EXIT buttons have only one additional feature.

Button	Description	Access Method
	Range feature: Exit AUTO and enter MANUAL ranging. In MANUAL, select next input range. EXIT to return to AUTO. AUTO is default.	Press the button once.
	Testing resistance signal from calibrator: When testing resistance signal from calibrator, it is necessary to press this button to change the maximum display to 4000 counts but the accuracy remains unchanged.	Press and hold the button while turning on the meter.
	Setup feature: Access Setup selections, the display shows "SET". In the Setup mode, each press of SETUP button steps to the next selection.	Press and hold the button for more than 1 second.
	Store feature: Store the current measurement value. Press EXIT to exit.	Press the button once.
	Recall feature: Recall the stored value. Press EXIT to exit the Recall feature.	Press and hold the button for more than 1 second.
	Setup feature: In Setup, press to select OFF at the selection of HIGH and LOW.	Press the button once after entering Setup mode.
	Hold feature: Press HOLD to freeze the displayed value. Press EXIT to release the display. Peak Hold feature: Press to access Peak Hold feature, the primary display shows PEAK HOLD. Press EXIT to exit.	Press the button once. Press and hold the button for over 1 second.
	In Setup, each press to select the digit you want to edit. In Recall, press to enable SEND feature In Store, press to toggle between clearing all the stored reading or start storing reading from the current index number.	Press the button once after entering Setup or Recall or Store mode.
	Steps to perform Peak Hold function:- Peak Value : True RMS Value (Sinewave). Peak Value is a half of Peak-to-Peak Value.	Input first, then press down Peak Hold button. Press EXIT button to quit the function. If measuring high voltage first, and then low voltage, Peak Hold needs to be reset.

Button	Description	Access Method
	Press to exit certain button functions and the meter will return to the factory default setting.	Press the button once.
	Press to turn the backlight on. It is possible to switch between 1st and the 2nd backlight level and Exit the feature by pressing this button. After exiting the light feature, it is necessary to press and hold the button for over 1 second to turn the backlight on again.	Press and hold the button for over 1 second.
	Press to display max, min and average values. Press EXIT to stop and return to current measurement mode.	Press the button once.
	In Setup, each press to decrement an Option.	Press the button once after entering SEND mode.
	Press to display max, min and average values. Press EXIT to stop and return to current measurement mode.	Press the button once.
	Press to output the data, AUTO mode switch off. The primary display shows "SEND". Press EXIT to exit.	Press and hold the button for over 1 second.
	In Setup, each press to decrement an Option. In Recall, each press to go back to the previous stored reading. In Store, each press to decrease a second on the storing interval. Press EXIT to exit.	Press the button once after entering SEND mode.
	Press to enter relative mode, the primary display shows . The left secondary display shows the present measurement value. The right secondary display shows the stored value. The primary display shows the present measurement value minus the stored value. Press EXIT to exit relative mode.	Press the button once.
	In Setup, each press to increment an Option. In Recall, each press to recall the next stored reading. In Store, each press to increase a second on the storing interval.	Press and hold the button for over 1 second.
	When it is at AC measurement mode, press the button to display AC+DC True RMS value in the primary display and the left secondary display "AC+DC".	Press the yellow button once.
	Use the blue button to select any range selector alternate function (labeled in blue).	Press the blue button once.
	Press and hold the button while turning on the meter to toggle to it's fastest 4000 counts for all functions. If you turn the meter off then on, or if the resuming from Auto Power Off mode, the meter will revert to 40,000 count mode.	

Function	Primary Display	Right Secondary Display	Left Secondary Display
DCV	The tested DC voltage value	No display	Full range: 4, 40, 400, 1000
ACV	The tested AC voltage value	The tested frequency value: 45.00Hz~ 100.0kHz	Full range: 4, 40, 400, 1000
DCmV	The tested DCmV value	No display	Full range: 400
Ω	The tested resistance value	No display	Full range: 400, 4, 40, 400, 4, 40
	The tested resistance value	No display	Full range value: 400
	The tested resistance value	No display	Full range: 4
Hz	The tested frequency value	No display	Full range: 40, 400, 4, 40, 400, 4, 40, 400
	The tested capacitance value	No display	Full range: 40, 400, 4, 40, 400, 4, 40
°C	The tested °C value	No display	1000
°F	The tested °F value	No display	1832
DC μ A	The tested DC μ A	No display	Full range: 400, 4000
AC μ A	The tested AC μ A	The tested frequency value: 45.00Hz~10.00kHz	Full range: 400, 4000
DCmA	The tested DCmA value	No display	Full range: 40, 400
ACmA	The tested ACmA value	The tested frequency value: 45.00Hz~10.00kHz	Full range: 400, 4000
DCA	The tested DC current value	No display	Full range: 10
ACA	The tested AC current value	The tested frequency value: 45.00Hz~10.00kHz	Full range: 10
STO	The current measurement reading	The value of the corresponding index number	Index number increase one. Index number: no.0001~no.0100
RCL	The recalled value	The total number of the stored value	Index number no.0001~no.0100
MAXMIN	Send		
REL Δ	The present measurement value minus the stored value	The stored value	The present measurement value

Selecting the Range

- Press RANGE to select either a fixed range or the autorange feature.
- Autoranging (AUTO lit in the display) always comes on initially when you select a new function. In autorange, the meter selects the lowest input range possible, ensuring that the reading appears with the highest available resolution.
- If AUTO is already on, press RANGE to enter MANUAL ranging in the present range. You can then select the next manual range each time you press RANGE.
- Return to autoranging by press EXIT.

Note: There is no MANUAL ranging on REL feature.

Analog Bar Graph

- The bar graph provides an analog indication of the measured input. For most measurement functions, the bar graph updates 10 times per second.
-

Using MAX MIN

- The MAX MIN mode stores minimum (MIN) and maximum (MAX) input values. When the input goes below the stored minimum value or above the stored maximum value, the meter beeps and stores the new value.
- Press MAX MIN to enter MAX MIN mode. The sampling time is every 2 seconds. The maximum reading and MAX are shown on the left secondary display. The minimum reading and MIN are shown on the right secondary display. The primary display shows the current measurement reading.
- Press MAX MIN the second time, the current measurement reading is shown on the left secondary display. The minimum reading and MIN are shown on the right secondary display. The primary display shows the maximum value.
- Press MAX MIN the third time, the current measurement reading is shown on the left secondary display. The maximum reading and MAX are shown on the right secondary display. The primary display shows the minimum value.
- Each subsequent press of MAX MIN steps through the above three modes.
- To exit MAX MIN mode, press EXIT.

Note: MAX MIN mode can only be used under MANUAL ranging mode.

OPERATION

Measuring Voltages

- To measure voltage, do the following:
 1. Insert the red test lead into the V terminal and the black test lead into the COM terminal.
 2. Set the range selector to V $\overline{\text{---}}$ or V~ or Hz % mV $\overline{\text{---}}$
 3. Connect the test leads across the object being measured.
 4. The measured value shows on the display. AC measurement displays the True RMS value. DC measurement displays the effective value of sine wave (mean value response).
- When the ACV function is selected, you can press the Yellow Button to view the AC+DC True RMS value in the primary display.
- The BLUE button cycles among mV $\overline{\text{---}}$ frequency and duty cycle.
- Special care should be taken when measuring high voltage.
- When voltage measurement has been completed, disconnect the test leads from the circuit under test and remove the test leads from the input terminals of the meter.

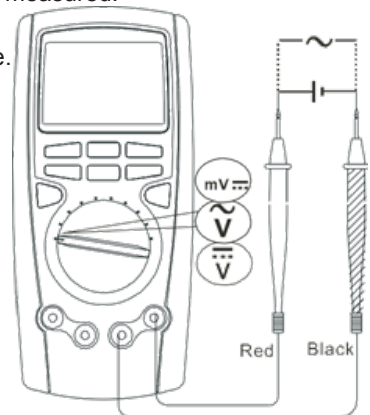

Warning: To avoid personal injury, or damage to the meter from electrical shock, do not attempt to measure voltages higher than 1000V, although readings may be obtained.

Measuring Current

- To measure AC or DC current proceed as follows:
 - Turn off power to the circuit. Discharge all high-voltage capacitors.
 - Insert the red test lead into the mA μ A or A terminal and black test lead into the COM terminal.
 - If you are using the A terminal, set the range selector to A \approx . If you are using mA μ A terminal, set the range selector to μ A \approx .
 - DC measurement is default, press blue button to select AC measurement.
 - Open the circuit path to be tested. Touch the red testing leads to the positive side of the break; touch the black probe to the negative side of the break. Reversing the leads will produce a negative reading, but will not damage the meter.
 - Turn on power to the circuit; then read the display. AC measurement displays the True RMS value. DC measurement displays the effective value of sine wave (mean value response).
 - Turn off power to the circuit and discharge all high- voltage capacitors. Remove the meter and restore the circuit to normal operation.
 - When the ACA function is selected, you can press the Yellow Button to view the AC+DC True RMS value in the primary display.

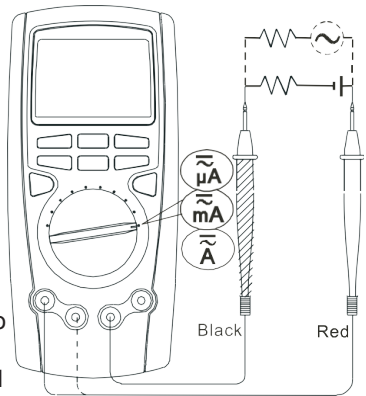

Note: The Blue Button is to choose AC or DC current.

- If the value to be measured is unknown, use the maximum measurement position and reduce the range step by step until a satisfactory reading is obtained.
- When the measured current is below 5A, continuous measurement is allowed.
- When the measured current is between 5A-10A, continuous measurement ≤ 10 sec and more than 15 minutes must be allowed between measurements.
- When current measurement has been completed, disconnect the test leads from the circuit under test and remove test leads from the input terminals of the meter.

Measuring Resistance

- To measure resistance, procede as follows:
 - Insert the red test lead into the Ω terminal and the black test lead into the COM terminal.
 - Set the range selector to $\rightarrow \rightarrow \Omega$ press BLUE button to select Ω measurement mode.
 - Connect the test leads across with the object being measured.
 - The measured value shows on the display.

Note: The BLUE button cycles among resistance, continuity, and diode.

- The LCD displays OL indicating open-circuit or the tested resistor value is higher than the maximum range of the meter.

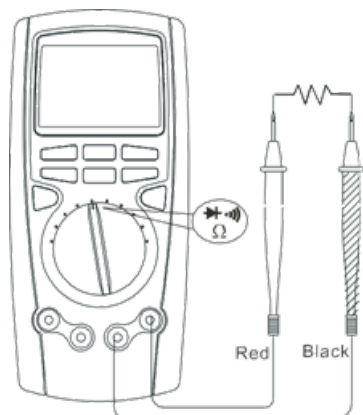

- When testing the resistance signal from the calibrator, it is necessary to press and hold the RANGE while turning on the meter to change the maximum display to 4000 counts but the accuracy remains unchanged.
- When resistance measurement has been completed, disconnect the test leads from the circuit under test and remove test leads from the input terminals of the meter.

Testing for Continuity

- Turn off power to the circuit. Discharge all high-voltage capacitors.
- To test for continuity proceed as follows:
 1. Insert the red test lead into the Ω terminal and the black lead into the COM terminal.
 2. Set the range selector to $\rightarrow \rightarrow \rightarrow \Omega$ press BLUE button to select $\rightarrow \rightarrow \rightarrow$ measurement mode and connect the test leads across with the object being tested.
 3. The beeper comes on continuously for open circuits, and will sound for conditions of less than $\leq 50\Omega$.

Note: The BLUE button cycles between resistance, continuity, and diode.

- When continuity measurement has been completed, disconnect the test leads from the circuit under test and remove test leads from the input terminals of the meter.

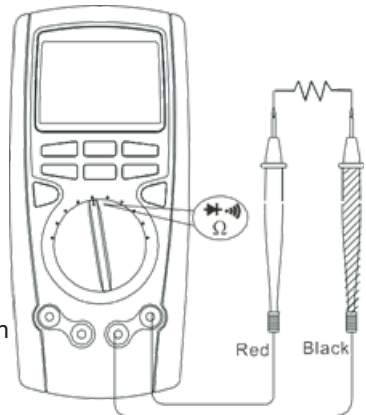

Testing Diodes

- Turn off power to the circuit. Discharge all high-voltage capacitors.
- Use the diode test to check diodes, transistors, and other semiconductor devices. The diode test sends a current through the semiconductor junction, then measures the voltage drop across the junction. A good silicon junction drops between 0.5V and 0.8V.
- To test for continuity proceed as follows:
 1. Insert the red test lead into the Ω terminal and the black lead into the COM terminal.
 2. Set the range selector to $\rightarrow \rightarrow \rightarrow \Omega$ press BLUE button to select $\rightarrow \rightarrow \rightarrow$ measurement mode and connect the test leads across with the object being tested.
 3. Place the red test lead on the component's anode and place the black test lead on the component's cathode.

Note: The BLUE button cycles between resistance, continuity, and diode.

- When continuity measurement has been completed, disconnect the test leads from the circuit under test and remove test leads from the input terminals of the meter.

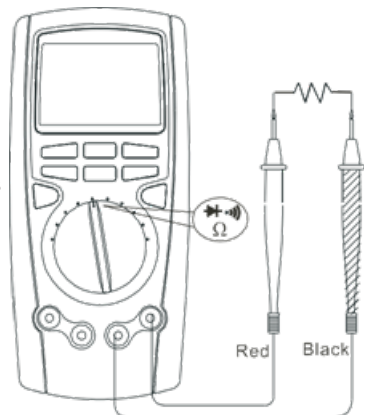

Measuring Capacitance

- To ensure accuracy, the meter will first internally discharge the capacitor under test. DIS.C will show on the display. Depending upon the size of the capacitor and the amount of discharge required, this process may take some time.
- To avoid damage to the meter or to the equipment under test, disconnect circuit power and discharge all high-voltage capacitors before measuring capacitance.
- Use the DC Voltage function to confirm that the capacitor is discharged.
- To measure capacitance, proceed as follows:
 1. Insert the red test lead into the $\text{---}||\text{---}$ terminal and the black lead into the COM terminal.
 2. Set the range selector to $\text{---}||\text{---}$ measurement mode, the meter may display a fixed reading which is an internal distributed capacitor value. For best accuracy when testing capacitors less than 10nF, the internal distributed capacitor value should be subtracted from the reading.

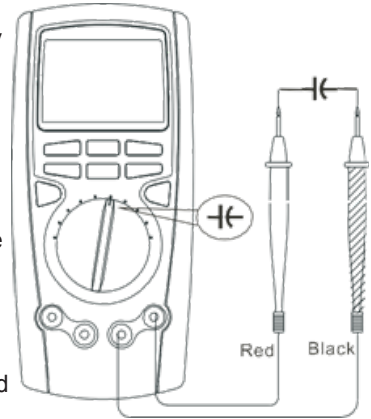

Note: To improve the measurement accuracy of small value capacitors (less than 10nF), press REL with the test leads open to subtract the residual capacitance of the meter and leads.

- It is recommended that the short test clip leads be used for capacitance measurement.
- The LCD displays OL indicating the tested capacitor is shorted or it exceeds the maximum range.
- Capacitors larger than 400 μ F take longer time. The analogue bar graph shows the time left before finishing the measurement.
- When capacitance measurement has been completed, disconnect the test leads from the circuit under test and remove test leads from the input terminals of the meter.

Measuring Frequency / Duty Cycle

To measure frequency and duty cycle, proceed as follows:

1. Insert the red test lead into the Hz terminal and the black test lead into the COM terminal.
 2. Set the range selector to %Hz or Hz % mV $\text{---}||\text{---}$ and press BLUE button to select the Hz measurement mode for frequency measurement or % for duty cycle measurement.
 3. Connect the test leads across the circuit being measured.
 4. The measured value shows on the primary display.
- When frequency measurement has been completed, disconnect the test leads from the circuit under test and remove test leads from the input terminals of the meter.

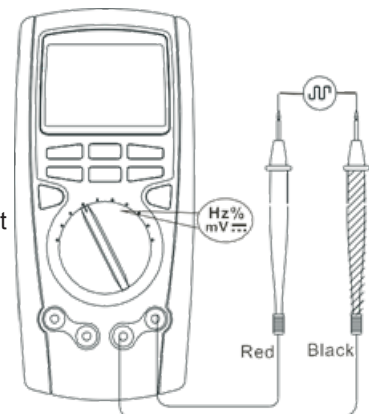

Measuring Temperature

Note: Do not apply voltage to the test leads when the meter is in temperature measuring mode.

1. Set the range selector to °C °F, the display shows OL. Short circuit the test leads to show the room temperature. The meter is default to Celsius degree unit, you can change units by press the BLUE button once you have selected the temperature function.
 2. Insert the point contact temperature probe into the right hand pair of meter terminals.
 3. Place the temperature probe onto the object being measured.
 4. The measured value shows on the display after several seconds.
- Nominal environmental temperature for using the meter is 18°~23° otherwise a false reading may be obtained especially in testing low temperatures.
 - The included point contact temperature probe can only be used with temperature up to 230°C or 440°F.
 - When temperature measurement has been completed, disconnect the temperature probe from the input terminals of the meter.

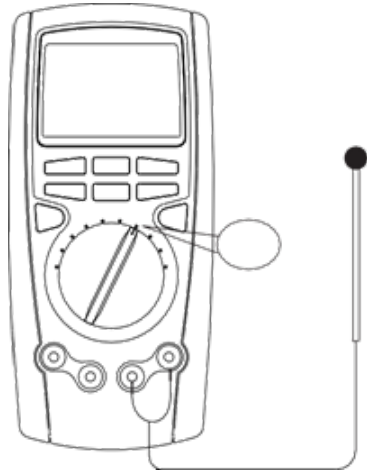

4~20mA loop current as % readout

- This mode shows the mA measured value or output level on a 4-20mA scale.
- Connect the Meter as follows:
- Set the range selector to mA \approx 4-20mA % and press BLUE button to select (4-20mA)% option.
- When the measured current is below 5A, continuous measurement is allowed.
- When the readings obtained is <4mA: the primary display shows LO
at 4mA: the primary display shows 0
at 20mA: the primary display shows 100
>20mA: the primary display shows HI
- When loop current measurement has been completed, disconnect the test leads from the circuit under test and remove test leads from the input terminals of the meter.

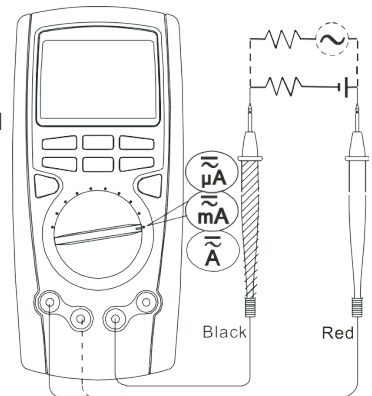

Storing and Clearing Readings

- To store readings, proceed as follows:
 1. Press STORE once, STO and “no.xxxx” displays to confirm the operation and the left secondary display shows the current measurement reading. Press to toggle between clearing the stored readings and start from the first readings or start from the last stored reading. Right secondary display shows the original number of records.
 2. Press STORE a second time and STO displays. The left secondary display shows the storing time interval in seconds, it is preset to zero.
 3. To change the interval in seconds by pressing + or - button. The interval can be as high as 255 seconds or as low as 0 second.
 4. Press and hold STORE to access the quick setting.
 5. Press STORE the third time, STO and no displays. The left secondary display shows the index number increase by one. The right secondary display shows the value of the corresponding index number, the primary display shows the current measurement reading.
- If there is no interval time set to store the reading, each press of STORE increments the reading by one index number.
- The maximum number of stored reading is 100 (for 72-7730A) and 9999 (for 72-7732A) When the stored readings memory is full, the meter will stop storing data.
- To exit, press EXIT.
- Automatic power off feature is disabled while the meter is in this mode.

Recalling Stored Readings



- Use the following procedure to recall the stored reading:
 - Press RECALL to recall the stored value and RCL displays to confirm the operation.
 - The left secondary display shows the index number “no.xxxx”.
 - The primary display shows the corresponding recalled data.
 - The right secondary display shows the total number of the stored data.
 - Press button to enable the SEND feature to export the data to the computer via USB. The software shows the data storing time and also the data value. After the data transferring is completed, the SEND feature will be disabled automatically.
 - Press + or - button to view additional stored reading.
 - Press and hold RECALL to access quick recalling.
 - Press EXIT to exit recalling.

Using Send

- When using a Send feature, please refer to the Installation Guide on the included CD-ROM.

Changing the Default Setting

- The meter allows you to change the default operating configuration by changing setup options made at the factory.
- It is recommended to change the default setting only when the Meter is in DCV measurement mode.
- To enter the Setup mode, turn the meter on and press and hold SETUP button for over 1 second.
- Each press of SETUP button steps to the next Selection. Each press of - or + button increments or decrements an option.

Selection	Option	Factory Default	Description
HIGH	Max. 40,000 (model 72-7732A), Max. 20,000 (model 72-7730A) Press ◀ to select off Press ▶ to select the digit you want to edit.	OFF	Over the upper limits, beeps intermitently
LOW	Max. 40,000 (model 72-7732A), Max. 20,000 (model 72-7730A) Press ◀ to select off Press ▶ to select the digit you want to edit.	OFF	Over the upper limits, beeps intermitently
	10 20 30 OFF	10 mins	10 mins power off 20 mins power off 30 mins power off Power off is disabled
	1 OFF	1	Beeps continuously and icon lights on No beep, icon flashes
	10 20 30 OFF	10	Backlight turns off in 10 sec Backlight turns off in 20 sec Backlight turns off in 30 sec Disable backlight feature
Analogue Bar Graph	Zero is in left hand side Zero is in the centre	Zero in Centre	Only applies to DCV, DCI and C° / F° functions

Saving Setup Options

- At each setup Option, store your choice and exit setup by press EXIT, advance to the next Option by press +.
- To exit the Setup mode without saving the present Option, press SETUP.

BATTERY AND FUSE REPLACEMENT

- If  icon appears on LCD, please replace the battery as follows:
- Disconnect test probes from circuits being measured, turn range selector to OFF position.
- Remove the screw from the battery cover, and separate the battery cover from the rear casing.
- Replace the 9V battery with a new one (6F22) noting the correct polarity.
- Refit the battery cover and tighten the screw.

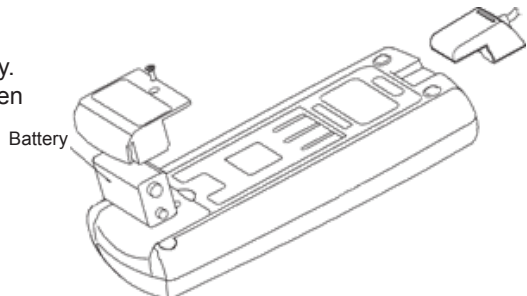

Replacing the Fuses

Warning: To avoid electrical shock, personal injury or damage to the Meter, use specified fuses ONLY in accordance with the following procedure.

- Turn the rotary switch to OFF and remove all connections from the terminals.
- Remove the 5 screws from the case bottom.
- Remove the fuse by gently prying one end loose, then lift out the fuse from its holder.
- Install ONLY replacement fuses with the identical type and specification as follows and make sure the fuse is fixed firmly in the bracket.
- Fuse 1: 0.5A, 1000V, fast type 6.3x32mm
- Fuse 2: 10A, 1000V, fast type 10.3x38mm
- Refit the case bottom and case top, and install the 5 screws.

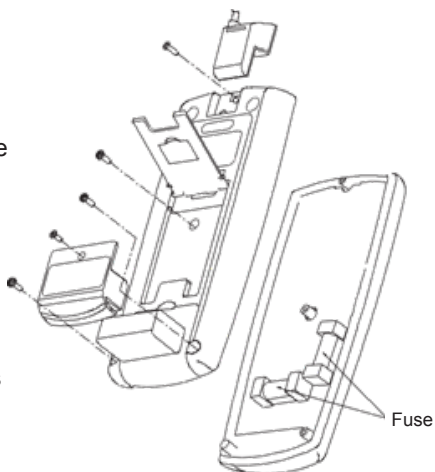

Note: Replacement of a fuse is seldom required, a blown fuse is nearly always the result of improper operation.

SPECIFICATIONS

Function	Range/description
Operating Temperature	0°~40°C (32°F~104°F)
Relative Humidity	≤75%@ 0°C~30°C below ≤50%@ 30°C~40°C
Battery Type	9V NEDA 1604 or 6F22 or 006P
Dimensions (H x W x L)	177 x 85 x 40mm)
Weight	340g incl battery
Range	Auto
Polarity	Auto
Tri digital display: Primary	40,000 counts (Model 72-7732A), 20,000 counts (Model 72-7730A)
Left Secondary:	4000 counts (Model 72-7732A), 2000 counts (Model 72-7730A)
Right Secondary:	4000 counts (Model 72-7732A), 2000 counts (Model 72-7730A)
Analogue bar graph	40 segments, updates 10 times / second
DC Voltage	0 to 1000V
AC Voltage true RMS	0 to 1000V 100kHz bandwidth
Basic accuracy	DC Voltage: 72-7730A/72-7732A: 0.05% AC Voltage: 72-7730A/72-7732A: 0.6%

Function	Range/description
DC Current	0 to 10A (5~10A for ≤10 seconds, interval ≥15 minutes)
AC Current, True RMS	0 to 10A (5~10A for ≤10 seconds, interval ≥15 minutes)
Resistance	0 to 40MΩ
Capacitance	0 to 40mF
Frequency	0~400MHz
Temperature	-40°C~1000°C(-40°F~1832°F)
STORE Readings	Up to 100 readings for 72-7730A or 9999 reading for 72-7732A may be saved by the user in a memory. These readings may be viewed by using Recall feature.

DC Voltage						
Range		Resolution	Accuracy		Overload Protection	Input Impedance
72-7730A	72-7732A		72-7730A	72-7732A		
200mV	400mV	0.01mV	±(0.05%+5)	±(0.25%+5)	1000V	~2.5gΩ
2V	4V	0.0001mV	±(0.08%+5)	±(0.05%+5)		~10mΩ
20V	40V	0.001mV				
200V	400V	0.01mV				
1000V	1000V	0.1mV	±(0.1%+8)	±(0.1%+8)		

AC Voltage (AC+DC measurement is available)						
Range		Resolution	Bandwidth	Accuracy		Input Impedance
72-7730A	72-7732A			72-7730A	72-7732A	
2V	400mV	0.01mV	45Hz~1kHz	±(0.6%+40)	±(0.4%+30)	Approx 10mΩ
			1kHz~10kHz	±(3%+40)	±(3%+30)	
			10kHz~100kHz	±(7%+40)	±(6%+30)	
20V	4V	0.0001mV	45Hz~1kHz	±(0.6%+40)	±(0.4%+30)	
			1kHz~10kHz	±(3%+40)	±(3%+30)	
			10kHz~100kHz	±(7%+40)	±(6%+30)	
200V	400V	0.01mV	45Hz~1kHz	±(0.6%+40)	±(0.4%+30)	
			1kHz~10kHz	±(5%+40)	±(5%+30)	
			10kHz~100kHz	Not Specified	Not Specified	
1000V	1000V	0.1mV	45Hz~1kHz	±(1.2%+40)	±(1%+30)	
			1kHz~10kHz	±(6%+40)	±(5%+30)	
			5kHz~100kHz	±(10%+40)	±(10%+30)	

Overload Protection: 1000V.

- True rms are valid from 10% of range to 100% of range
- AC crest factor can be up to 3.0 except 1000V where it is 1.5.
- A residual reading of 80 digits with test leads shorted, will not affect stated accuracy.
- When frequency is lower than 100kHz, the accuracy guarantee range 10% -100%
- For AC+DC measurement, add (1%-35 digits) of reading based on above table.

DC Current					
Range		Resolution	Accuracy		Overload Protection
72-7730A	72-7732A		72-7730A	72-7732A	
200μA	400μA	0.01μA	±(0.15%+20)	±(0.1%+15)	0.5A, 1000V fast type fuse Ø6.3 x 32mm
2000μA	4000μA	0.1μA		±(0.15%+15)	
20mA	40mA	0.001mA			
200mA	400mA	0.01mA	±(0.7%+30)	±(0.5%+30)	
10A	10A	0.001mA			

AC Current (AC+DC measurement is available)						
Range		Resolution	Bandwidth	Accuracy		Input Impedance
72-7730A	72-7732A			72-7730A	72-7732A	
200μA	400μA	0.01μA	45Hz~1kHz 1kHz~10kHz	±(0.8%+15) ±(1.5%+40)	±(0.7%+15)	0.5A, 1000V fast type fuse Ø6.3 x 32mm
2000μA	4000μA	0.1μA				
20mA	400mA	0.001mA		±(1%+40)		
200mA	400mA	0.01mA				
10A	10A	0.001A	45Hz~1kHz	±(2%+20)	±(1.5%+20)	10A, 1000V fast type fuse Ø6.3 x 32mm
			1kHz~10kHz	±(6%+40)	±(5%+40)	

Overload Protection: 1000V.

- True rms are valid from 10% of range to 100% of range
- AC crest factor can be up to 3.0.
- A residual reading of 80 digits with test leads shorted, will not affect stated accuracy.
- When frequency is lower than 100kHz, the accuracy guarantee range 10% -100%
- For AC+DC measurement, add (1%-35 digits) of reading based on above table.

Resistance					
Range		Resolution	Accuracy		Overload Protection
72-7730A	72-7732A		72-7730A	72-7732A	
200Ω	400Ω	0.01Ω	±(0.4%+20) +test leads OC value	±(3%+8) +test leads OC value	1000V
2kΩ	4kΩ	0.0001kΩ	±(0.4%+20)	±(3%+8)	
20kΩ	40kΩ	0.001kΩ			
200kΩ	400kΩ	0.01kΩ	±(0.8%+20)	±(0.5%+20)	
2mΩ	4mΩ	0.0001mΩ	±(1%+40)	±(1%+40)	
20mΩ	40mΩ	0.001mΩ	±(1.5%+40)	±(1.5%+40)	

Continuity Test

Range	Resolution	Overload Protection
	0.01Ω	1000V

- Open circuit voltage approximate -1.2V.
- The buzzer does not sound when the test resistance is >60Ω
- The beeper sounds continuously for open circuits and if test resistance is ≤40Ω

Diode Test

Range	Resolution	Overload Protection
	0.0001V	1000V

- Open circuit voltage approximate 2.8V.
- A good silicone junction drops between 0.5V and 0.8V

Capacitance					
Range		Resolution	Accuracy		Overload Protection
72-7730A	72-7732A		72-7730A	72-7732A	
20nF	40nF	0.001nF	±(1.2%+20) + capacitance value of open circuit test leads	±(1%+20) + capacitance value of open circuit test leads	1000V
200nF	400nF	0.01nF	±(1.2%+20)	±(1.2%+20)	
2μF	4μF	0.0001μF			
20μF	40μF	0.001μF	±(1.2%+40)		
200μF	400μF	0.1μF	±(1.5%+40)	±(1.2%+20)	
2mF	4mF	0.0001μF	±(5%+40)	±(5%+20)	
20mF	40mF	0.001μF	Not specified	Not specified	

Frequency					
Range		Resolution	Accuracy		Overload Protection
72-7730A	72-7732A		72-7730A	72-7732A	
20Hz	40Hz	0.001Hz	$\pm(0.1\%+15)$	$\pm(0.01\%+8)$	1000V
200Hz	400Hz	0.01Hz			
2kHz	4kHz	0.0001kHz			
20kHz	40kHz	0.001kHz			
200kHz	400kHz	0.01kHz			
2mHz	4mHz	0.0001mHz			
20mHz	40mHz	0.001mHz			
200mHz	400mHz	0.01mHz	Not specified	Not specified	

Input amplitude 'a' as follows (DC = 0)

- When 10Hz~40MHz : $200\text{mV} \leq 'a' \leq 30\text{Vrms}$
- When > 40MHz : Not specified.

Temperature (Celsius)

Range	Resolution	Accuracy	Overload Protection
-40°C~40°C	0.1°C	$\pm (3\%+30)$	1000V
40°C~400°C		$\pm (1\%+30)$	
400°C~1000°C		$\pm (2\%+10)$	

Temperature (Fahrenheit)

Range	Resolution	Accuracy	Overload Protection
-40°F~32°F	0.1°F	$\pm (4\%+50)$	1000V
32°F~752°F		$\pm (1.5\%+50)$	
752°F~1832°F		$\pm (2\%+18)$	

Included is a K-Type (nickel chromium ~ nickel silicon) point contact temperature probe which could only measure temperature below 230°C .

If you want to measure temperature higher than 230°C, you must use the rod contact temperature probe.

4~20mA Loop Current

Range	Resolution	Accuracy	Overload Protection
(4~20mA) %	0.01%	$\pm (1\%+50)$	0.5A, 1000V, fast type fuse, 6.3x32mm

When the readings obtained is:

- < 4mA, the primary display shows LO
- 4mA, the primary display shows 0%....
- 20mA, the primary display shows 100%
- > 20mA, the primary display shows HI

CLEANING

- Periodically wipe the case with damp cloth and mild detergent. Do not use abrasives or solvents for cleaning.
- Clean the measurement probe tips occasionally, as dirt on the probes can affect reading accuracy.

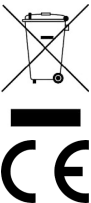

INFORMATION ON WASTE DISPOSAL FOR CONSUMERS OF ELECTRICAL & ELECTRONIC EQUIPMENT

These symbols indicate that separate collection of Waste Electrical and Electronic Equipment (WEEE) or waste batteries is required. Do not dispose of these items with general household waste. Separate for the treatment, recovery and recycling of the materials used. Waste batteries can be returned to any waste battery recycling point which are provided by most battery retailers. Contact your local authority for details of the battery and WEEE recycling schemes available in your area.

Made in China. PR2 9PP

Man Rev 1.0