

Kunde / customer :

Artikelnummer / part number : **820 552 711**

Datum / Date : **2013-03-01**

Bezeichnung :

description : **Disk Varistor Standard WE-VD**

DIAM: **5** mm

ROHS Compliant

A Elektrische Eigenschaften / Electrical Properties :

TECHNICAL DATA

Part Number	Breakdown Voltage	Tolerance	Working Voltage		Clamping Voltage	Current Clamp. Volt.	Peak Current Withstanding C.
	(V@mA) (*1)		AC	DC	V (*2)	(A)	A (*3)
820 552 711	430	10	275	350	745	5	400

* 1 The varistor voltage was measured at 0.1 mA current for 5 mm diameter and 1 mA current for other

* 2 The Clamping voltage measured at "Current Clamping Voltage" see next column

* 3 The Peak Current was tested at 8/20 μ s waveform for 1 time

Part Number	Rated Wattage	Energy	Capacitance	UL	Certification CSA	VDE	Diameter
	(W)	J (*4)	pF (*5)	(*6)	(*7)	(*8)	(mm)
820 552 711	0.1	16.5	65	yes	yes	yes	5

* 4. The Energy measured at 10/1000 μ s waveform for 1 time

* 5. The capacitance value measured at standard frequency @ 1kHz

* 6. Certification UL N° E332875

* 7. Certification CSA N° 224856

* 8. Certification VDE N° 40016998 & 40016986

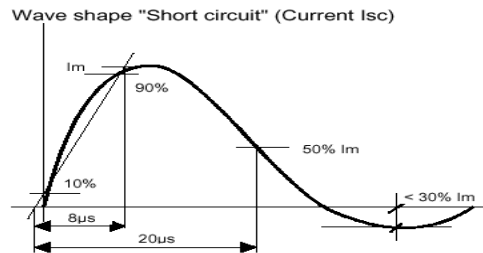

Wave during	T1	T2
8/20 μ s	8 μ s	20 μ s
10/1000 μ s	10 μ s	1000 μ s

ORDER CODE

820

Varistor Type

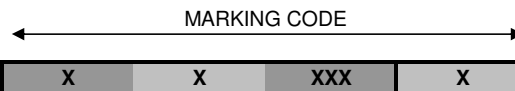

Serie

Diameter

Vrms Voltage

Tolerance

Code

S

Special Type

Disc Varistor

5 = Standard
4 = High Surge

5 = 5 mm
7 = 7 mm
1 = 10 mm
4 = 14 mm
2 = 20 mm

5 = 5%
1 = 10%
6 = 15%
2 = 20%
7 = 25%
3 = 30%

Example:
180 = 18 V
271 = 270 V
102 = 1 000 V

Kunde / customer :

Artikelnummer / part number : **820 552 711**

Bezeichnung :

description : **Disk Varistor Standard WE-VD**

DIAM: **5** mm

B Mechanische Abmessungen / Dimensions :

SIZE

Diameter*	Ø 5	Ø 7	Ø 10	Ø 14	Ø 20
D max.	7,5	9,0	12,5	16,5	23,0
d +/-0,05	0,6	0,6	0,8	0,8	1,0
F +/-1,0	5,0	5,0	7,5	7,5	10,0
H max.	11	13	18	22	28
H1 max	3,5	3,5	5,0	5,0	5,0
L1 min.	25	25	25	25	25
L min.	24	24	24	24	24

(mm) - *Nominal Disk Diameter of Bare Disk



Table of T max., A & P₁. Unit : (mm)

Diameter	Ø 5			Ø 7			Ø 10			Ø 14			Ø 20		
	T max A+/-0,8	P ₁		T max A+/-0,8	P ₁		T max A+/-0,8	P ₁		T max A+/-0,8	P ₁		T max A+/-0,8	P ₁	
110	4,5	1,4	3,0	4,5	1,4	3,0	4,9	1,4	3,0	5,0	1,5	3,0	5,2	1,5	3,0
140	4,5	1,5	3,0	4,5	1,5	3,0	4,9	1,5	3,0	5,0	1,6	3,0	5,3	1,6	3,0
170	4,7	1,5	3,0	4,7	1,5	3,0	5,1	1,5	3,0	5,2	1,7	3,0	5,4	1,7	3,0
200	4,7	1,6	3,0	4,7	1,6	3,0	5,1	1,6	3,0	5,2	1,8	3,0	5,4	1,8	3,0
250	4,7	1,8	3,0	4,7	1,8	3,0	5,1	1,8	3,0	5,2	2,0	3,0	5,4	2,0	3,0
300	5,0	1,8	3,0	5,0	1,8	3,0	5,5	1,8	3,0	5,6	2,0	3,0	5,6	2,0	3,0
350	5,0	2,0	3,0	5,0	2,0	3,0	5,5	2,0	3,0	5,6	2,2	3,0	5,6	2,2	3,0
400	5,5	2,3	3,0	5,5	2,3	3,0	6,0	2,3	3,0	6,1	2,5	3,0	6,1	2,5	3,0
500	3,8	1,4	3,0	3,8	1,4	3,0	4,3	1,4	3,0	4,4	1,6	3,0	4,9	1,8	3,0
600	3,9	1,4	3,0	3,9	1,4	3,0	4,4	1,4	3,0	4,5	1,6	3,0	5,1	1,8	3,0
750	4,1	1,5	3,0	4,1	1,5	3,0	4,5	1,5	3,0	4,6	1,7	3,0	5,3	1,9	3,0
950	4,5	1,8	3,0	4,5	1,8	3,0	4,9	1,8	3,0	5,1	2,0	3,0	5,6	2,2	3,0
111	4,1	1,6	3,0	4,1	1,6	3,0	4,5	1,6	3,0	4,7	1,8	3,0	5,2	2,0	3,0
131	4,2	1,6	3,0	4,2	1,6	3,0	4,6	1,6	3,0	4,8	1,8	3,0	5,3	2,0	3,0
141	4,3	1,7	3,0	4,3	1,7	3,0	4,7	1,7	3,0	4,9	1,9	3,0	5,4	2,1	3,0
151	4,4	1,7	3,0	4,4	1,9	3,0	4,8	1,9	3,0	5,0	2,1	3,0	5,5	2,3	3,0
171	4,6	1,9	3,0	4,6	2,0	3,0	5,0	2,0	3,0	5,2	2,1	3,0	5,7	2,5	3,0
191	4,8	1,9	3,0	4,8	2,1	3,0	5,2	2,2	3,0	5,4	2,3	3,0	5,9	2,7	3,0
211	4,9	1,9	3,0	4,9	2,1	3,0	5,3	2,2	3,0	5,5	2,3	3,0	6,0	2,7	3,0
231	5,1	2,4	3,0	5,1	2,5	3,0	5,5	2,5	3,0	5,7	2,7	3,0	6,2	2,9	3,0
251	5,3	2,6	3,5	5,3	2,6	3,5	5,7	2,8	3,5	5,9	2,8	3,5	6,4	3,0	3,5
271	6,1	2,7	3,5	6,1	2,9	3,5	6,5	3,1	3,5	6,7	3,1	3,5	7,2	3,3	3,5
301	6,4	2,8	3,5	6,4	2,9	3,5	6,8	3,2	3,5	7,0	3,3	3,5	7,5	3,5	4,0
321	6,6	3,1	4,0	6,6	3,1	4,0	7,0	3,7	4,0	7,2	3,7	4,0	7,7	3,9	4,0
351	6,9	3,4	4,0	6,9	3,4	4,0	7,3	4,0	4,0	7,5	4,0	4,0	8,0	4,2	4,0
381	7,2	3,7	4,0	7,2	3,7	4,0	7,6	4,6	4,0	7,8	4,4	4,0	8,3	4,7	4,0
421	7,5	4,0	4,0	7,5	4,0	4,0	8,0	5,0	4,0	8,2	4,7	4,0	8,7	5,0	4,0
461	7,9	4,3	4,0	7,9	4,3	4,0	8,4	5,0	4,0	8,6	4,9	4,0	9,1	5,1	4,0
481				8,1	4,5	4,0	8,6	5,2	4,0	8,8	5,2	4,0	9,3	5,4	4,0
511				8,3	4,7	4,0	8,8	5,2	4,0	9,0	5,2	4,0	9,5	5,4	4,0
551							9,4	6,0	4,0	9,6	6,0	4,0	10,1	6,3	4,0
621							9,9	6,0	4,0	10,1	6,2	4,0	10,7	6,4	4,0
681							10,5	6,3	4,0	10,7	6,7	4,0	11,2	6,9	4,0
102							12,6	9,8	6,0	12,8	10,2	6,0	13,5	10,4	6,0

Kunde / customer :
 Artikelnummer / part number : **820 552 711**
 Bezeichnung :
 description : **Disk Varistor Standard WE-VD** DIAM: **5** mm

C Markierung / Marking Spec. :

MARKING

Würth Elektronik

Characteristic

Certification

Date Code

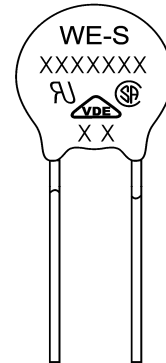
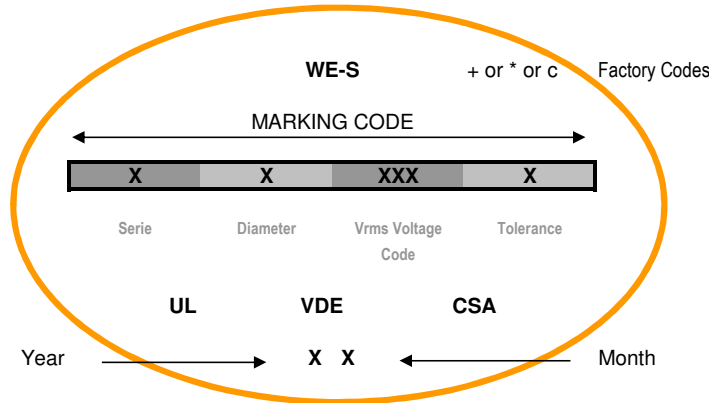

GENERAL CHARACTERISTICS

Max. reponse time	25 n sec
Operating temperature:	-40 to +85°C
Insulation resistance (500VDC):	Over 1000 MΩ

LEAD FREE SOLDERING

Solder	Tin 100%
Soldering temperature at	255°C +/- 5 °C
Profile soldering	270°C during 10s

D Verpackung / Packaging:

QUANTITY PER PACKING UNIT

Diameter	Ø 5		Ø 7		Ø 10		Ø 14		Ø 20	
	Bulk	Reel	Bulk	Reel	Bulk	Reel	Bulk	Reel	Bulk	Reel
Voltage Serie	(Box)		(Box)		(Box)		(Box)		(Box)	
110 ~ 300	5 000	1 500	5 000	1 500	2 500	1 000	1 500	750	750	500
350 ~ 400	5 000	1 500	5 000	1 500	2 500	1 000	1 500	750	750	500
500 ~ 210	5 000	1 500	5 000	1 500	2 500	1 000	1 500	750	750	500
230 ~ 250	5 000	1 500	5 000	1 500	2 500	1 000	1 500	750	750	500
271 ~ 301	5 000	1 500	5 000	1 000	2 500	750	1 500	750	750	500
321 ~ 461	4 000	1 000	4 000	1 000	1 500	500	750	500	450	500
481 ~ 102	-	-	-	-	-	-	1 500	500	750	500

QUANTITY PER CARTON UNIT

Packaging	Bulk (Box)	Reel	Reel Ø 14 / 20
Box size	290 x 155 x 110	350 x 350 x 108	350 x 350 x 7
Carton size	310 x 328 x 250	371 x 371 x 590	370 x 370 x 468
One carton with	4 boxes	5 boxes (10 reels)	6 boxes

Kunde / customer :

Artikelnummer / part number : **820 552 711**

Bezeichnung :

description : **Disk Varistor Standard WE-VD**

DIAM: **5** mm

E Rollenspezifikation / Tape and Reel Specification :

TAPE

1/2" pitch

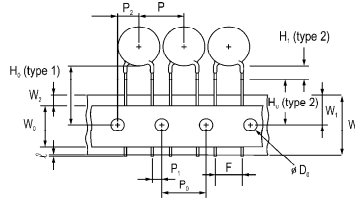

1.0" pitch

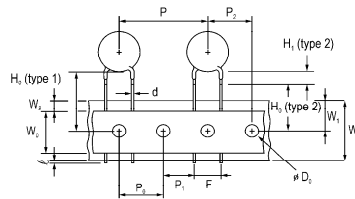

REEL DIMENSION

(Unit : mm)

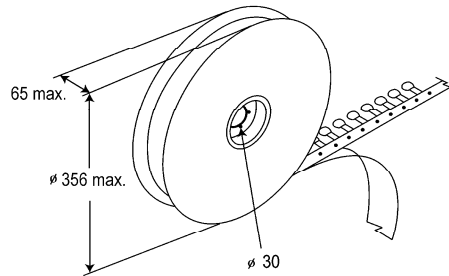

Item	Ø 5 / 7	Ø 10	Ø 10 / 14 / 20	Ø 14 / 20
Taping pitch	1/2"		1.0"	
I	1,1 mm maxi.		1,1 mm maxi.	
H ₁ (type 2)	3,5 mm max.	5 mm max.	5 mm maxi.	
H ₀ (type 2)	16 +/-0,5 mm		16 +/-0,5 mm	
H ₀ (type 1)	16 à 21 mm		16 à 21 mm	
h	+/-2 mm		+/-2 mm	
W	18 mm +1 / - 0,5 mm		18 mm +1 / - 0,5 mm	
W ₀	10 mm		12 mm	
W ₁	9 mm +0,75 / -0,5 mm		9 mm +0,75 / -0,5 mm	
W ₂	3 mm maxi.		3 mm maxi.	
F	5 mm +0,8 / -0,2 mm		7,5 mm +0,8 / -0,2 mm	10 mm +0,8 / -0,2 mm
P	12,7 mm +/-1 mm		25,4 mm +/-1 mm	
P ₀	12,7 mm +/-0,3 mm		12,7 mm +/-0,3 mm	
P ₁	3,85 mm +/-0,7 mm		8,95 mm +/-0,7 mm	7,7 mm +/-0,7 mm
P ₂	6,35 mm +/-1,3 mm		12,7 mm +/-1,3 mm	
D ₀	4 mm +/-0,2 mm		4 mm +/-0,2 mm	
d	0,6 mm +/-0,05 mm		0,8 mm +/-0,05 mm	1,0 mm +/-0,05 mm
t ₁	0,7 mm +/-0,05 mm		0,6 mm +/-0,05 mm	
t ₂	1,6 mm maxi.		1,8 mm maxi.	

Freigabe erteilt / general release:	Kunde / customer				
			RoD	Version 5.1	2013-03-01
Datum / date	Unterschrift / signature		JP Penlou	Version 5	2010-07-19
			JP Penlou	New P/N	2006-06-01
Geprüft / checked	Würth Elektronik		JP Penlou	Customer Layout	2006-05-11
			JP Penlou	Factory codes	2005-11-16
	2013-03-01		JP Penlou	Lead Free Marking	2004-10-19
	Kontrolliert / approved		Name	Änderung / modification	Datum / date
		JP. Penlou			

Würth Elektronik eiSos GmbH & Co.KG