



POWER CONDITIONERS — PRODUCT GUIDE

TABLE OF CONTENTS

CONSTANT VOLTAGE FERRORESONANT POWER CONDITIONERS	1
OPERATING CHARACTERISTICS	3
CVS HARDWIRED SERIES	5
MCR HARDWIRED SERIES	6
MCR PORTABLE SERIES	8
ELECTRICAL CONNECTIONS	9
MODEL COMPARISON — SPECIFICATIONS	11
SOLATRON™ PLUS SERIES - THREE PHASE POWER CONDITIONERS	12

CONSTANT VOLTAGE FERRORESONANT POWER CONDITIONERS

Sola's ferroresonant power conditioners protect equipment from all power problems other than a complete loss of power. They excel at tightly regulating voltage within $\pm 1.0\%$ for input variations up to $+10\%/-20\%$, provide superior noise attenuation and are designed to withstand the harshest electrical environments. With no moving parts, Sola's ferroresonant power conditioners are virtually maintenance free.

In 1938, Sola was awarded the first patent for a ferroresonant power conditioner; the constant voltage transformer. Since then, Sola has remained at the forefront of ferroresonant power conditioning. Today, the sinewave output provided by Sola's ferroresonant power conditioners is essential for any solid state application.

Whether you purchase a Sola CVS or MCR, you can count on an average of 25 years of dependable service. Every ferroresonant power conditioner is manufactured to exacting specifications and subjected to rigorous quality control. Sola uses cruciform-type construction with precision die-cut shunts, gaps and spacings between windings. This design technique is superior to ferroresonant transformers utilizing E and I type laminations with loose shunts, gaps and variable spacings between windings. The cruciform-type construction provides more consistent electrical characteristics and quieter operation than other types of construction.

WHAT IS FERRORESONANCE?

Ferroresonance is the principle behind Sola's CVS and MCR power conditioners. Simply put, ferroresonance is the property of a transformer design in which the transformer contains two separate magnetic paths with limited coupling between them. The output contains a parallel resonant tank circuit and draws power from the primary to replace power delivered to the load.

Note that "resonance" in ferroresonance is similar to that in linear circuits with series or parallel inductors and capacitors, where the impedance peaks at a particular frequency. In a nonlinear circuit, such as Sola's ferroresonant transformers, "resonance" is used to reduce changes in supply voltage to provide a more consistent voltage to the load.

A magnetic device is nonlinear. Its reluctance changes abruptly above a certain magnetic flux density. At this point, the magnetic device is defined as being in saturation. The design of the Sola transformer allows one magnetic path (the resonant path) to be in saturation, while the other is not (see Figure 1). As a result, further change in the primary voltage will not translate into changes in the saturated or secondary voltage and voltage regulation results.

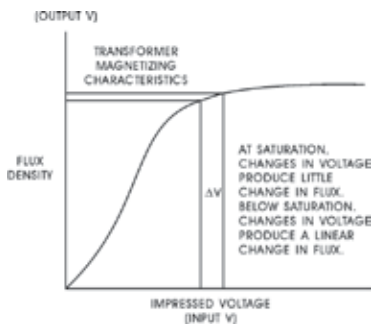

Figure 1

HOW DO SOLA'S FERRORESONANT POWER CONDITIONERS WORK?

Sola's ferroresonant products consist of a resonant electrical circuit utilizing a high-leakage reactance. The electrical circuit is comprised of four windings (see Figure 2): a primary winding (1), a capacitor (resonant) winding (2), a compensating winding (3) and an output winding (4). The primary and the compensating windings are wound on the center leg of the iron core. The capacitor and the output windings are wound on the same center leg, but isolated from the primary and compensating windings by a magnetic shunt.

When an AC current is induced in the primary, the resulting magnetic flux induces a voltage in the capacitor winding. Because of the reluctance (magnetic resistance) of the air gaps in the shunt path, the resulting voltage is about equal to the turns ratio of the windings. As the primary voltage is increased, the flux through the core structure increases.

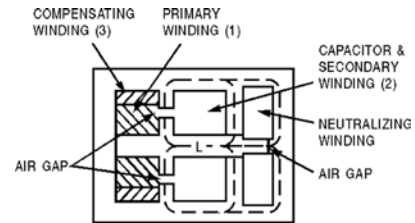

Figure 2

When the flux density becomes such that the inductive reactance between the primary and secondary approaches the capacitive reactance at the frequency of the line voltage, the circuit becomes resonant. The voltage across the capacitor winding then increases to a stable value that is higher than the turns ratio. This action has the effect of increasing the magnetic density in the portion of the magnetic circuit on the resonant winding to a value that is larger than the magnetic flux density of the shunt.

Further variations in flux, produced by changes in the primary, are largely recirculated by the shunt, and the resultant voltage change in the resonant circuit is small. The compensating winding is designed so that the change in voltage induced in it by a change in input voltage is, roughly, equal to the change in output voltage. This winding is connected in series (but with opposite polarity) to the secondary winding. The resulting output voltage remains constant, regardless of variations in the primary voltage.

CONSTANT VOLTAGE FERRORESONANT POWER CONDITIONERS

HARMONIC BLOCKING

The input current to a ferroresonant transformer contains a negligible harmonic current relative to the fundamental. This relationship remains about the same no matter what kind of load is placed on the output winding. Even switch-mode power supplies that may demand harmonic currents as high as 150% relative to the fundamental will reflect near sine wave currents back to the utility. This is due to the blocking action of the two separate magnetic paths of the ferroresonant transformer.

FERRORESONANT POWER CONDITIONERS AND HARMONICS

A Sola ferroresonant power conditioner will have essentially harmonic free output because of the addition of a neutralizing coil. This coil neutralizes the harmonics in a manner best explained by first considering the device as a conventional transformer with the neutralizing coil disconnected. Though this coil is now open circuited, it has a voltage induced in it as a portion of the magnetic flux passes through the center leg of the core to the outer legs. Since some of the primary flux links this coil, fundamental voltage is present. The resultant voltage has a high odd-harmonic content due to the leakage flux from the output winding.

This leakage flux can return to the output winding by two paths. One bypasses the neutralizing coil. The other path links the neutralizing coil completely. By controlling the reluctance of these magnetic paths, one can control the degree of secondary flux coupled to the neutralizing coil. The neutralizing coil is connected with its polarity additive to the secondary (or output coil) as shown in Figure 3.

The output of the newly formed regulator has constant voltage with a wave shape almost completely free of harmonics. The harmonics are still present in the neutralizing coil. Since those harmonics present in the neutralizing coil are induced by the flux from the secondary winding, the harmonics in each coil are approximately 180 degrees out of phase. This results in their cancellation. Proper control of turns ratio and magnetic path reluctance contribute to the generation of a sinusoidal output... even with a square wave input.

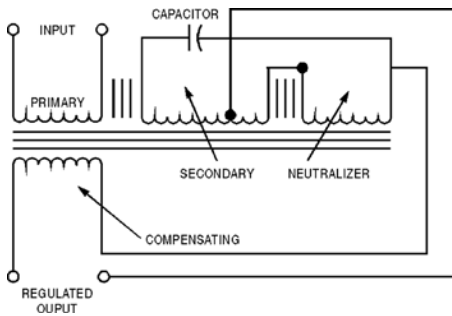

Figure 3

REGULATION

Sola's CVS power conditioners will hold output voltages to $\pm 1.0\%$ or less with input variations as great as $\pm 15\%$ ($115V \pm 15\%$ or $120V +10\%/-20\%$). Units operated at less than rated load will maintain approximately $\pm 1\%$ regulation over a wider input line voltage variation. Output meets NEMA voltage specifications even when input voltage drops to 65% of nominal. The output versus input voltage relationship for a typical CVS is shown in Figure 4. Note: MCR line regulations: $\pm 3\%$ for 60 Hz; $\pm 5\%$ for 50 Hz.

The typical performances shown in Figure 5 indicate that most of the residual changes take place near the lower (95V) and upper (130V) ends of the input range. It is possible to improve output regulation if line variations remain within a restricted range near the center of the nameplate range (for example, 100-120V).

Normally, the output voltage will rise as the load is decreased. Typical percentages for changes in resistive load from full to zero load is shown below:

Conditioner Rating VA	Increase in Output Voltage due to Load Removal
30	3%
60 & 120	2%
250 & Over	1%

Except as noted, all characteristics of Sola's CVS products also apply to the MCR series.

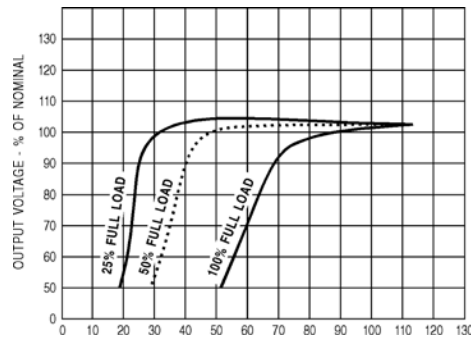

Figure 4

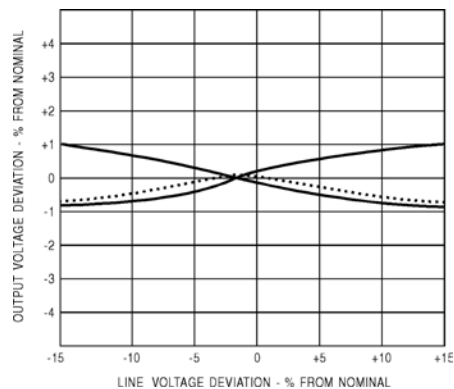

Figure 5

OPERATING CHARACTERISTICS

POWER FACTOR

Sola power conditioners will regulate any power factor load. Output voltage is a function of load current and load power factor (see Figure 6). If lower voltage under lagging power factor is objectionable, correction may be made with capacitors at the load. "Median" value of output voltage will vary from the nameplate rating if the load has a power factor other than that for which the transformer was designed. Load regulation will also be relatively greater as the inductive load power factor is decreased (see Figure 6). However, the resulting median values of output voltage will be regulated against supply line changes at any reasonable load or load power factor.

EFFICIENCY

The copper magnet wire and lamination material used in Sola products are selected so high efficiency is achieved. This results in typical power efficiencies of 90% or higher. Whether or not an external load is being served, current will be drawn from the line whenever the primary is energized, since the capacitor remains connected in the circuit.

INPUT CHARACTERISTICS

Since Sola power conditioners include a resonant circuit which is energized whether or not it is serving load, the input current at no load or light load may run 50% or more of the full primary current. As a result, the temperature of the unit may rise to substantially full-load level, even at light or no load. Input power factor will average 90-100% at full load, but may drop to about 75% at half load and 25% at no load. In any case, the current is always leading. The input no load watts are about 12.5% of the VA rating.

FREQUENCY

Output voltage varies linearly with a change of frequency of the input voltage. This change is about 1.5% of the output voltage for each 1% change in input frequency and in the same direction as the frequency change.

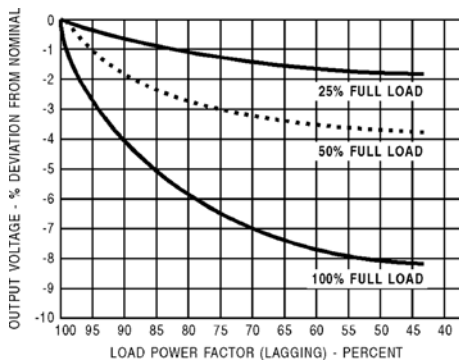

Figure 6

MOTOR LOADS

Because of the fast response time of the Sola circuit, any current-limiting characteristic must be taken into account for transient overloads such as motor starting and solenoid operation. In general, the Sola constant voltage regulator must have a capacity nearly equal to the maximum demand made on it, even for an instant. To determine the power rating of the regulator, peak motor-starting current or solenoid inrush current should be measured or power factor correcting capacitors should be used to reduce the starting VA of the load.

RESPONSE TIME

An important advantage of Sola's ferroresonant transformer is its fast response time compared with other types of AC regulators. Transient changes in supply voltage are usually corrected within 1-1/2 cycles or less; the output voltage will not fluctuate more than a few percent, even during this interval.

OVERLOAD AND SHORT CIRCUITS

When the load is increased beyond the regulator's rated value, a point is reached where the output voltage suddenly collapses and will not regain its normal value until the load is partially released. Under direct short circuit, the load current is limited to approximately 150-200% of the rated full load value and the input watts to less than 10% of normal.

A constant voltage regulator will protect both itself and its load against damage from excessive fault currents. Fusing of load currents may not be necessary. The actual value of short-circuit current varies with the specific design and rating. Units may be operated indefinitely at short-circuit. This characteristic protects the unit itself as well as the load and load circuit being served. Typical overload performance is shown in Figure 7.

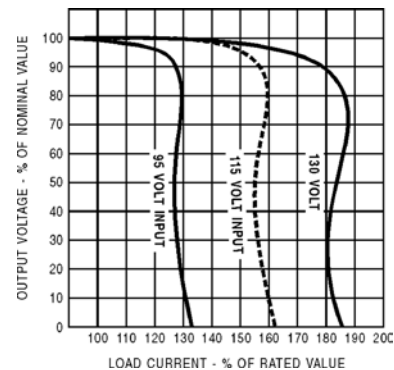

Figure 7

OPERATING CHARACTERISTICS

TEMPERATURE

Sola's ferroresonant power conditioners are very stable with respect to temperature. The change in output voltage is only 0.025% per degree centigrade. Units are factory adjusted to +2%/-0% of nominal, with full load and nominal input voltage. This adjustment to the high side of nominal is to compensate for the natural temperature drift of about 1% that takes place during initial turn-on or warm-up. When the unit warms up to operating temperature, the voltage typically falls about 1%.

At a stable operating temperature, the output voltage will change slightly with varying ambient temperatures. This shift is equal to approximately 1% for each 40°C of temperature change.

The normal maximum temperature rise of a Sola power conditioner may fall anywhere in the range of 40°C to 110°C depending on the type and rating. The nominal design ambient range is between -20°C and +50°C (-20°C to +40°C for 70 - 1000 VA, 60 Hz portable models).

EXTERNAL MAGNETIC FIELD

In almost all applications, this effect may be disregarded. The exclusive Sola "wide outside leg" construction (U.S. Patent 2,806,199) reduces stray magnetic fields to a practical minimum. On critical applications, care should be taken in orientation of the core with respect to critical circuits to minimize the effect of the field.

PHASE SHIFT

The phase difference which exists between input and output voltages is in the range of 120 degrees to 140 degrees at full load. This phase difference varies with the magnitude and power factor of the load, and to a lesser extent, with changes in line voltage and load power factor.

PARALLEL OPERATION

Constant voltage regulators of the same Sola catalog number may be connected in parallel to obtain larger load capacity. Both input and output connections must be made in parallel. See Figure 8.

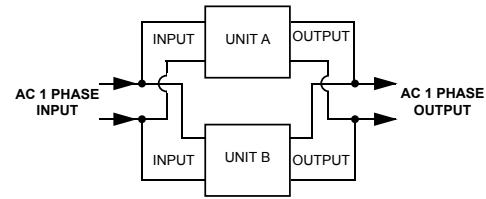

Figure 8

1. The catalog number must end in -8 and must be larger than the 1 KVA. Any units with 7-digit model numbers (no dash) or are not -8 cannot be paralleled. Portable units cannot be paralleled.
2. On 60 Hz models smaller than 5 KVA, do not parallel connect the 208 or 240 volt windings.
3. On 50 Hz models, do not parallel connect the 220 volt center tap outputs and the 240 volt center tap outputs.
4. All input and output paralleling wires must be tied in an external paralleling "box". Do not attempt to jumper the wires of one unit to the terminal block of the other unit. The terminal block is not rated to carry the currents of both units.
5. The input of each unit must be properly fused separately.
6. Failure to adhere to all of these requirements may damage the output windings.

CVS HARDWIRED SERIES

Superior voltage regulation of $\pm 1\%$ sets the CVS series apart from other power conditioning technologies on the market. Extremely tight regulation is accomplished by SolaHD's ferroresonant transformer technology. The CVS recreates a well regulated sinusoidal waveform that is well isolated from input disturbances including:

- Impulses
- Swells
- Brownouts
- Sags
- Severe waveform distortion

No other power conditioning technology provides as complete a solution against these power quality disturbances. The CVS series is ideal for applications where even a small change in voltage level can lead to unscheduled downtime, misoperation, incorrect data or scrapped production.



APPLICATIONS

- Industrial automation and control equipment PLCs
- Analytical laboratory and factory automating equipment
- Photo processing equipment
- Sound/recording systems
- Photographic enlargers
- Broadcast equipment

FEATURES

- Superior voltage regulation of $\pm 1\%$
- Surge protection tested to ANSI/IEEE C62.41, Class A & B waveform
- Harmonic filtering
- Hardwired
- Acts as a step-up/step-down transformer
- Galvanic isolation provides exceptional circuit protection
- 25 year typical mean time between failure
- No maintenance required

CERTIFICATIONS AND COMPLIANCES

-  Listed
- UL 1012
- CSA C22.2 No. 107.1
- RoHS Compliant

RELATED PRODUCTS

- On-line UPS (S4K Industrial)
- Surge Protection
- Three Phase Power Conditioners
- Active Tracking® Filters

SELECTION TABLES: SINGLE PHASE

GROUP 1 – CVS SERIES, 60 HZ

VA	Catalog Number	Voltage Input	Voltage Output	Height in (mm)	Width in (mm)	Depth in (mm)	Ship Weight lbs (kg)	Design Style	Elec Conn
30	23-13-030-2	120	120	7.00 (177.8)	4.00 (101.6)	5.00 (127.0)	9.0 (4.08)	1	J
60	23-13-060-2	120	120	7.00 (177.8)	4.00 (101.6)	5.00 (127.0)	9.0 (4.08)	1	J
120	23-22-112-2	120, 240	120	8.00 (203.2)	4.00 (101.6)	5.00 (127.0)	13.0 (5.90)	1	J
250	23-23-125-8	120, 240, 480	120	11.00 (279.4)	6.00 (152.4)	8.00 (203.2)	29.0 (13.15)	1	G
500	23-23-150-8	120, 208, 240, 480	120, 240	13.00 (330.2)	9.00 (228.6)	7.00 (177.8)	42.0 (19.05)	1	H
1000	23-23-210-8	120, 208, 240, 480	120, 240	17.00 (431.8)	9.00 (228.6)	7.00 (177.8)	65.0 (29.48)	1	H
2000	23-23-220-8	120, 208, 240, 480	120, 240	18.00 (457.2)	13.00 (330.2)	10.00 (254.0)	111.0 (50.35)	1	H
3000	23-23-230-8	120, 208, 240, 480	120, 240	19.00 (482.6)	13.00 (330.2)	10.00 (254.0)	142.0 (64.41)	1	H
5000	23-23-250-8	120, 208, 240, 480	120, 240	28.00 (711.2)	13.00 (330.2)	10.00 (254.0)	222.0 (100.70)	1	H
7500*	23-28-275-6	240, 480	120, 240	27.00 (685.8)	25.00 (635.0)	9.00 (228.6)	365.0 (165.56)	2	J

* This unit is  Listed only.

MCR HARDWIRED SERIES

The MCR Hardwired Series provides excellent noise filtering and surge protection to safeguard connected equipment from damage, degradation or misoperation. Combined with the excellent voltage regulation inherent to SolaHD's ferroresonant design, the MCR can increase the actual Mean Time Between Failure (MTBF) of protected equipment. The MCR is a perfect choice where dirty power, caused by impulses, swell, sags, brownouts and waveform distortion can lead to costly downtime because of damaged equipment.

APPLICATIONS

- Industrial automation and control equipment PLCs
- Machine tools
- Computer loads and electronic equipment
- Robotics
- Semiconductor fabrication equipment

FEATURES

- $\pm 3\%$ output voltage regulation
- Noise attenuation
 - 120 dB common mode
 - 60 dB transverse mode
- Surge protection tested to ANSI/IEEE C62.41 Class A & B Waveform:
 - <10 V let through typical
- Acts as a step-up or step-down transformer
- Harmonic filtering
- Hardwired
- Galvanic isolation provides exceptional circuit protection
- 25 year typical MTBF
- No maintenance required



CERTIFICATIONS AND COMPLIANCES

All Models

- RoHS Compliant

Selection Table: Group 2

- cUL US Listed (120VA-750VA Units) (1-5kVa ("-C8") Units)
 - UL 1012, CSA C22.2 No. 107.1
- UL Listed (7.5kVA-15kVA Units) (1-5kVa ("-8") Units)
 - UL 1012

Selection Table: Group 3

- cUL US Listed (500VA-3kVA Units)
 - UL 1012, CSA C22.2 No. 107.1
- SF Certified (5kVA-15kVA Units)
 - CSA C22.2 No. 66

Selection Table: Group 4

- cUL US Listed
 - UL 1012, CSA C22.2 No. 107.1

RELATED PRODUCTS

- On-line UPS (S4K Industrial)
- Surge Protection
- Three Phase Power Conditioners
- Active Tracking® Filters

DESIGN STYLES (CVS AND MCR HARDWIRED)

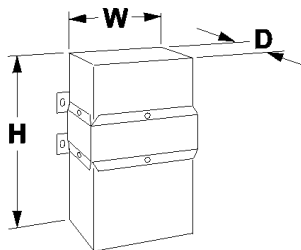

DESIGN STYLE 1

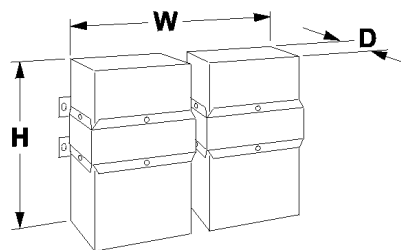

DESIGN STYLE 2

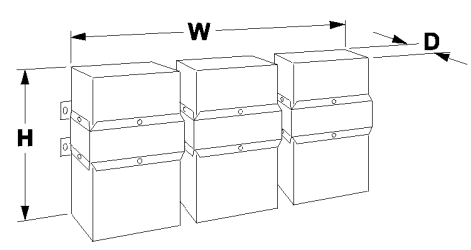

DESIGN STYLE 3

MCR HARDWIRED SERIES

SELECTION TABLES: SINGLE PHASE

GROUP 2 – MCR SERIES, 60 HZ ONLY

VA	Catalog Number	Voltage Input	Voltage Output	Height in (mm)	Width in (mm)	Depth in (mm)	Ship Weight lbs (kg)	Design Style	Elec Conn
120	63-23-112-4	120, 208, 240, 480	120	9.00 (228.6)	4.00 (101.6)	5.00 (127.0)	15.0 (6.80)	1	D
250	63-23-125-4	120, 208, 240, 480	120	10.00 (254.0)	6.00 (152.4)	8.00 (203.2)	27.0 (12.25)	1	D
500	63-23-150-8	120, 208, 240, 480	120, 208, 240	13.00 (330.2)	9.00 (228.6)	7.00 (177.8)	37.0 (16.78)	1	E
750	63-23-175-8	120, 208, 240, 480	120, 208, 240	14.00 (355.6)	9.00 (228.6)	7.00 (177.8)	52.0 (23.60)	1	E
1000*	63-23-210-8	120, 208, 240, 480	120, 208, 240	17.00 (431.8)	9.00 (228.6)	7.00 (177.8)	62.0 (28.12)	1	E
1500*	63-23-215-8	120, 208, 240, 480	120, 208, 240	17.00 (431.8)	13.00 (330.2)	9.00 (228.6)	95.0 (43.10)	1	E
2000*	63-23-220-8	120, 208, 240, 480	120, 208, 240	18.00 (457.2)	13.00 (330.2)	9.00 (228.6)	109.0 (49.44)	1	E
3000*	63-23-230-8	120, 208, 240, 480	120, 208, 240	19.00 (482.6)	13.00 (330.2)	9.00 (228.6)	142.0 (64.41)	1	E
5000*	63-23-250-8	120, 208, 240, 480	120, 208, 240	28.00 (711.2)	13.00 (330.2)	9.00 (228.6)	222.0 (100.70)	1	E
7500	63-28-275-8	208, 240, 480	120, 208, 240	27.00 (685.8)	26.00 (660.4)	9.00 (228.6)	362.0 (164.20)	2	F
10000	63-28-310-8	208, 240, 480	120, 208, 240	28.00 (711.2)	26.00 (660.4)	9.00 (228.6)	446.0 (202.30)	2	F
15000	63-28-315-8	208, 240, 480	120, 208, 240	28.00 (711.2)	38.00 (965.2)	10.00 (254.0)	710.0 (322.05)	3	F

* Canadian option:  units must be ordered by changing “-8” (UL only) to “-C8”.

GROUP 3 – MCR SERIES, 60 HZ ONLY

VA	Catalog Number	Voltage Input	Voltage Output	Height in (mm)	Width in (mm)	Depth in (mm)	Ship Weight lbs (kg)	Design Style	Elec Conn
500	63-31-150-8	600	120, 208, 240	13.00 (330.2)	9.00 (228.6)	7.00 (177.8)	38.0 (17.24)	1	B
1000	63-32-210-8	600	120, 208, 240	17.00 (431.8)	9.00 (228.6)	7.00 (177.8)	62.0 (28.12)	1	B
2000	63-32-220-8	600	120, 208, 240	18.00 (457.2)	13.00 (330.2)	10.00 (254.0)	109.0 (49.44)	1	B
3000	63-32-230-8	600	120, 208, 240	19.00 (482.6)	13.00 (330.2)	10.00 (254.0)	142.0 (64.41)	1	B
5000	63-29-250-8	208, 240, 480, 600	120, 208, 240	28.00 (711.2)	13.00 (330.2)	10.00 (254.0)	221.0 (100.24)	1	A
7500	63-29-275-8	208, 240, 480, 600	120, 208, 240	27.00 (685.8)	25.00 (635.0)	10.00 (254.0)	360.0 (163.30)	2	A
10000	63-29-310-8	208, 240, 480, 600	120, 208, 240	28.00 (711.2)	25.00 (635.0)	10.00 (254.0)	441.0 (200.03)	2	A
15000	63-29-315-8	208, 240, 480, 600	120, 208, 240	28.00 (711.2)	38.00 (965.2)	10.00 (254.0)	706.0 (320.24)	3	A

GROUP 4 – MCR SERIES, 50 HZ ONLY (±5% OUTPUT VOLTAGE REGULATION)

VA	Catalog Number	Voltage Input	Voltage Output	Height in (mm)	Width in (mm)	Depth in (mm)	Ship Weight lbs (kg)	Design Style	Elec Conn
120	63-23-612-8	110, 120, 220, 240, 380, 415	110, 120, 220, 240	9.00 (228.6)	6.00 (152.4)	8.00 (203.2)	24.0 (10.90)	1	C
250	63-23-625-8	110, 120, 220, 240, 380, 415	110, 120, 220, 240	11.00 (279.4)	6.00 (152.4)	8.00 (203.2)	27.0 (12.25)	1	C
500	63-23-650-8	110, 120, 220, 240, 380, 415	110, 120, 220, 240	13.00 (330.2)	9.00 (228.6)	7.00 (177.8)	40.0 (18.14)	1	C
1000	63-23-710-8	110, 120, 220, 240, 380, 415	110, 120, 220, 240	18.00 (457.2)	9.00 (228.6)	7.00 (177.8)	64.0 (29.03)	1	C
2000	63-23-720-8	110, 120, 220, 240, 380, 415	110, 120, 220, 240	18.00 (457.2)	13.00 (330.2)	10.00 (254.0)	113.0 (51.26)	1	C
3000	63-23-730-8	110, 120, 220, 240, 380, 415	110, 120, 220, 240	27.00 (685.8)	13.00 (330.2)	10.00 (254.0)	162.0 (73.48)	1	C
5000	63-23-750-8	110, 120, 220, 240, 380, 415	110, 120, 220, 240	30.00 (762.0)	13.00 (330.2)	10.00 (254.0)	266.0 (120.66)	1	C
7500	63-28-775-8	220, 240, 380, 415	110, 120, 220, 240	28.00 (711.2)	26.00 (660.4)	10.00 (254.0)	393.0 (178.26)	2	C1
10000	63-28-810-8	220, 240, 380, 415	110, 120, 220, 240	30.00 (762.0)	26.00 (660.4)	10.00 (254.0)	490.0 (222.26)	2	C2
15000	63-28-815-8	220, 240, 380, 415	110, 120, 220, 240	30.00 (762.0)	38.00 (965.2)	10.00 (254.0)	776.0 (352.00)	3	C2

MCR PORTABLE SERIES

The MCR provides excellent noise filtering and surge protection to protect connected equipment from damage, degradation or misoperation. Combined with the excellent voltage regulation inherent to SolaHD's ferroresonant design, they can increase the actual Mean Time Between Failure (MTBF) of protected equipment. These units are a perfect choice where dirty power caused by impulses, swell, sags, brownouts and waveform distortion can lead to costly downtime because of damaged equipment.

APPLICATIONS

- Computers/ Printers
- Telephone/FAX systems
- POS terminals
- Security systems
- Laboratory equipment
- LAN networks

FEATURES AND BENEFITS

- $\pm 3\%$ output voltage regulation
- Noise attenuation
 - 120 dB common mode
 - 60 dB transverse mode
- Surge protection tested to ANSI/IEEE C62.41 Class A & B waveform (<10 V let-through typical)
- Harmonic filtering
- Galvanic isolation provides exceptional circuit protection.
- Point-of-use protection (cord & plug connected)
 - Easy & Flexible Installation



MCR Portable Series





- 25 year typical MTBF
- No maintenance required

CERTIFICATIONS AND COMPLIANCES

All Models

- RoHS Compliant
-  Listed
 - UL 1012

Select Models

-  Listed (1500VA Units)
 - UL 1012, CSA C22.2 No. 66
-  Certified (70VA-1kVA Units)
 - CSA C22.2 No. 66

SELECTION TABLES: SINGLE PHASE

GROUP A - MCR PORTABLE SERIES, 60 HZ

VA	Catalog Number	Voltage Input/ Output	Height (inch)	Width (inch)	Depth (inch)	Ship Weight (lbs)	Receptacle (No.) Type (NEMA)	Plug (NEMA)
70	63-13-070-6	120	6	7	9	18	(4) 5-15R	5-15P
150	63-13-115-6	120	6	7	9	21	(4) 5-15R	5-15P
250	63-13-125-6	120	6	7	9	26	(4) 5-15R	5-15P
500	63-13-150-6	120	9	9	16	32	(4) 5-15R	5-15P
750	63-13-175-6	120	9	9	16	64	(4) 5-15R	5-15P
1000	63-13-210-6	120	9	9	16	69	(4) 5-15R	5-15P
1500*	63-13-215-6	120	11	11	17	95	(6) 5-15R	5-20P
2000	63-13-220-6	120	11	11	17	115	(4) 5-15R, (1) L5-30R	L5-30P
3000**	63-13-230-6	120	11	11	17	143	(4) 5-15R, (1) L5-30R	L5-50P

* 

**  only

ELECTRICAL CONNECTIONS

A

Primary Voltage	Interconnect	Connect Lines To
208	H1 to H4 H2 to H5	H1 & H5
240	H1 to H4 H3 to H6	H1 & H6
480	H3 to H4	H1 & H6
600	H3 to H4	H1 & H7
Secondary Voltage	Interconnect	Connect Lines To
120		X1 & X2 or X3 & X2
208		X4 & X5
240		X1 & X3

MCR 60 HZ 5000–15000 VA

B

175-650 V

Primary Voltage	Interconnect	Connect Lines To
600		H1 & H2
Secondary Voltage	Interconnect	Connect Lines To
120		X1 & X2 or X3 & X2
208		X4 & X5
240		X1 & X3

MCR 60 HZ 500–3000 VA

C

Primary Voltage	Interconnect	Connect Lines To
110-120	H1 to H3 H2 to H4	H1 & H4
220-240	H2 to H3	H1 & H4
380-415	H2 to H3	H1 & H5
Secondary Voltage	Interconnect	Connect Lines To
110		X1 & X2 or X3 & X2
120		X4 & X2 or X5 & X2
220		X1 & X3
240		X4 & X5

MCR 50 HZ 120–5000 VA

C1

Primary Voltage	Interconnect	Connect Lines To
220-240	H1 to H3 H2 to H5	H1 & H5
380-415	H2 to H3	H1 & H4
Secondary Voltage	Interconnect	Connect Lines To
110		X1 & X2 or X2 & X3
120		X4 & X2 or X5 & X2
220		X1 & X3
240		X4 & X5

MCR 50 HZ 7500 VA

C2

Primary Voltage	Interconnect	Connect Lines To
220-240	H2 to H3	H1 & H4
380-415	H2 to H3	H1 & H5
Secondary Voltage	Interconnect	Connect Lines To
110		X1 & X2 or X3 & X2
120		X4 & X2 or X5 & X2
220		X1 & X3
240		X4 & X5

MCR 50 HZ 10000–15000 VA

D

H5 380-520V
H4 190-260V
H3 175-235V
H2 95-130V
H1 Common

Primary Voltage	Interconnect	Connect Lines To
120		H1 & H2
208		H1 & H3
240		H1 & H4
480		H1 & H5
Secondary Voltage	Interconnect	Connect Lines To
120		X1 & X2

MCR 60 HZ 120–250 VA

ELECTRICAL CONNECTIONS

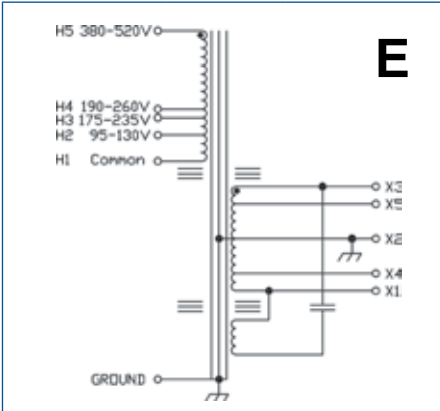

Primary Voltage	Interconnect	Connect Lines To
120		H1 & H2
208		H1 & H3
240		H1 & H4
480		H1 & H5
Secondary Voltage	Interconnect	Connect Lines To
120		X1 & X2 or X3 & X2
208		X4 & X5
240		X1 & X3

MCR 60 HZ 500-5000 VA

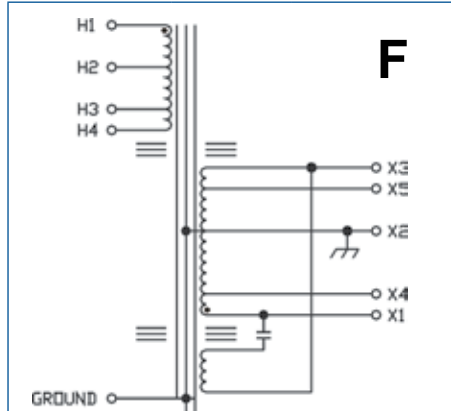

Primary Voltage	Interconnect	Connect Lines To
208		H2 & H3
240		H2 & H4
480		H1 & H4
Secondary Voltage	Interconnect	Connect Lines To
120		X1 & X2 or X3 & X2
208		X4 & X5
240		X1 & X3

MCR 60 HZ 7500, 10000 AND 15000 VA

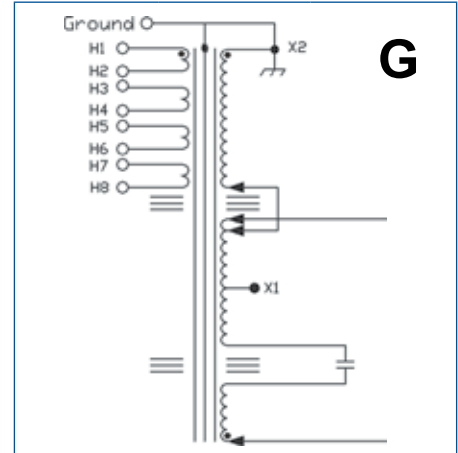

Primary Voltage	Interconnect	Connect Lines To
120	H1 to H3 to H5 to H7 H2 to H4 to H6 to H8	H1 & H2
240	H2 to H3 H6 to H7 H1 to H5 H4 to H8	H1 & H4
480	H2 to H3 H4 to H5 H6 to H7	H1 & H8
Secondary Voltage	Interconnect	Connect Lines To
120		X1 & X2

CVS 60 HZ 250 VA ONLY

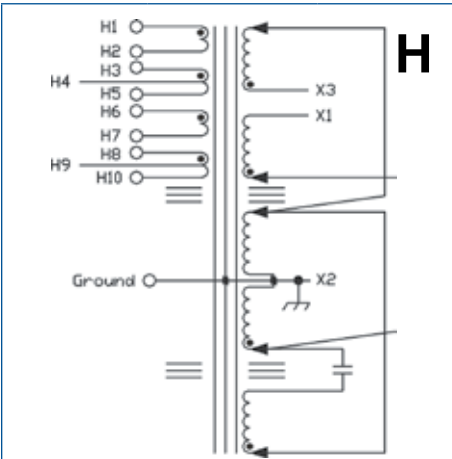

Primary Voltage	Interconnect	Connect Lines To
120	H1 to H3 to H6 to H8 H2 to H5 to H7 to H10	H1 & H2
208	H2 to H3 H7 to H8 H1 to H6 H4 to H9	H1 & H4
240	H2 to H3 H7 to H8 H1 to H6 H5 to H10	H1 & H5
480	H2 to H3 H5 to H6 H7 to H8	H1 & H10
Secondary Voltage	Interconnect	Connect Lines To
120		X1 & X2 or X3 & X2
240		X1 & X3

CVS 60 HZ 500-5000 VA

Series-Multiple Primary with Tap for two input voltages **J**

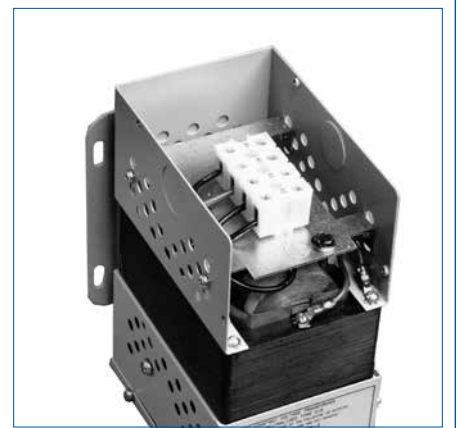
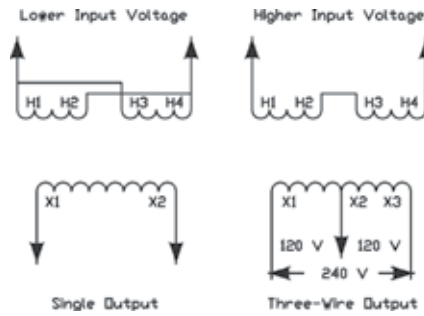

Open MCR/ CVS terminal

30 & 60 VA Primary Voltage	120 VA Primary Voltage	7500 VA Primary Voltage	Interconnect	Connect Lines To
120	N/A	N/A	Note: H3 & H4 are not used	H1 & H2
N/A	120	240	H1 to H3 H2 to H4	H1 & H4
N/A	240	480	H2 to H3	H1 & H4
30 & 60 VA Secondary Voltage	120 VA Secondary Voltage	7500 VA Secondary Voltage	Interconnect	Connect Lines To
120	120	N/A		X1 & X2
N/A	N/A	120		X1 & X2 or X3 & X2
N/A	N/A	240		X1 & X3

Note: Secondaries are not grounded. Ground X₂ per Code.

CVS 60 HZ 30-120 VA & 7500 VA

SPECIFICATIONS

SPECIFICATIONS - MODEL COMPARISON

Description	Hardwired CVS	Hardwired MCR	Portable MCR	Portable MCR
VA Ratings	30 to 7500 VA	120 to 15000 VA	70 to 3000 VA	250, 500, 1000 VA
Input Voltage Range	+10/-20% of nominal	+10/-20% of nominal	+10/-20% of nominal	+10/-20% of nominal
Voltage Regulation	±1% for an input line variation of +10/-20%. No loss of output for line loss of 3 mSec.	±3% for an input line variation of +10/-20%. (50 Hz units ±5%). No loss of output for complete line loss of 3 mSec.	±3% for an input line variation of +10/-20% (50 Hz units ±5%). No loss of output for complete line loss of 3 mSec.	±3% for an input line variation of +10/-20% (50 Hz units ±5%). No loss of output for complete line loss of 3 mSec.
Overload	Limits output current to a maximum of 2x rated current	Limits output current to a maximum of 2x rated current	Limits output current to a maximum of 2x rated current	Limits output current to a maximum of 2x rated current
Output Harmonic Distortion	3% total RMS content at full load	3% total RMS content at full load	3% total RMS content at full load	3% total RMS content at full load
Noise Isolation	40 dB common and normal code	120 dB common mode 60 dB normal mode	120 dB common mode 60 dB normal mode	120 dB common mode 60 dB normal mode
Surge Suppression	Up to 6000 Volt surges are suppressed to a let through of less than 1% per ANSI/IEEE C62.41 - 1980 Class A & B waveforms	Up to 6000 Volt surges are suppressed to a let through of less than 1% per ANSI/IEEE C62.41 - 1980 Class A & B waveforms	Up to 6000 Volt surges are suppressed to a let through of less than 0.2% per ANSI/IEEE C62.41 - 1980 Class A & B waveforms	Up to 6000 Volt surges are suppressed to a let through of less than 0.2% per ANSI/IEEE C62.41 - 1980 Class A & B waveforms
Efficiency	Up to 92% at full load	Up to 92% at full load	Up to 90% at full load	Up to 87% at full load
Operating Temperature	-20 °C to +50 °C (-4 °F to +122 °F)	-20 °C to +50 °C (-4 °F to +122 °F)	-20 °C to +40 °C (-4 °F to +104 °F)	-20 °C to +40 °C (-4 °F to +104 °F)
Audible Noise	32 dB to 65 dB	35 dB to 65 dB	34 dB to 49 dB	43 dB
Warranty	10 + 2 years	10 + 2 years	10 + 2 years	10 + 2 years

All values are typical and may vary based on VA ratings of actual units. For specific data, call Technical Services at (800) 377-4384

SOLATRON™ PLUS SERIES - THREE PHASE POWER CONDITIONERS

APPLICATIONS

- Automatic Packaging Machinery
- Large Machine Tool Equipment
- UPS Bypass Circuits
- Retail Store
- Process Equipment

FEATURES

- Rugged, industrial construction
- High overload capability
- High MTBF - No fans used
- No power factor restriction on loads
- Tight regulation for protection against sag (-25%) and swell (+10%) conditions
- No load current interruption for auto-bypass mode
- Status indicating lights
- Shielded, copper wound isolation transformer
- Surge protection to ANSI/IEEE Standards
- High efficiency (96%) microprocessor controlled on-load tap changer
- Automatic over and under voltage regulation. Auto restart upon power loss and return
- Two year limited warranty



CERTIFICATIONS AND COMPLIANCES

-  Listed
 - UL 1012
 - UL 1449, 3rd Edition
 - CSA C22.2 No.107.1

MECHANICAL SPECIFICATIONS

Indicators	Indicating Lamps: 2 amber (over temperature and bypass mode), 1 green (regulated output present)		
Connections	Field wired, terminal blocks		
Size	H IN (MM)	W IN (MM)	D IN (MM)
	42 (1016)	28 (712)	26 (661)

ENVIRONMENTAL SPECIFICATIONS

Audible Noise	Less than 50 dBA at 3 feet
Ambient Temperature	Operating - 0 °C to +40 °C (+32 °F to +104 °F) Storage - 0 °C to +80 °C (+32 °F to +176 °F)
Operating Altitude	10,000 feet, maximum
Operating Humidity	95% relative (non-condensing)

ELECTRICAL SPECIFICATIONS

Power Ratings	20, 30, 50, 75 kVA, Three Phase*
Nominal Voltages	See Selection Table
Input Voltage Range	-25% to +10% of nominal rated voltage
Output Voltage Range	Regulated to ± 3% of nominal voltage with an input voltage range of -25% to +10%.
Response Time	Responds to any line variation in <1.5 cycles typical.
Technology	Enhance Voltage Regulation (EVR), Microprocessor controlled electronic tap switching. 6 taps switched at zero current crossing with no output interruption.
Operating Frequency	57-63 Hz
Load Power Factor	No Restriction
Insulation Resistance	100 megohms from winding to core measured at 500 Vdc
Efficiency	96% typical
Overload Capability	1000% of rated load for 1 second 200% of rated load for 1 minute
EMI	Less than 0.2 gauss at a distance of 3 ft.

SOLATRON™ PLUS SERIES - THREE PHASE POWER CONDITIONERS

SELECTION GUIDE

Output kVA	Catalog Number	Vac Input	Vac Output	Ship Weight lbs (kg)
208 VAC INPUT, 208Y/120 VAC OUTPUT, 60 HZ				
20	63TAA320	208	208Y/120	600.0 (273.00)
30	63TAA330	208	208Y/120	750.0 (341.00)
50	63TAA350	208	208Y/120	950.0 (432.00)
75	63TAA375	208	208Y/120	1200.0 (545.00)
480 VAC INPUT, 208Y/120 VAC OUTPUT, 60 HZ				
20	63TCA320	480	208Y/120	600.0 (273.00)
30	63TCA330	480	208Y/120	750.0 (341.00)
50	63TCA350	480	208Y/120	950.0 (432.00)
75	63TCA375	480	208Y/120	1200.0 (545.00)
480 VAC INPUT, 480Y/277 VAC OUTPUT, 60 HZ				
20	63TCC320	480	480Y/277	600.0 (273.00)
30	63TCC330	480	480Y/277	750.0 (341.00)
50	63TCC350	480	480Y/277	950.0 (432.00)
75	63TCC375	480	480Y/277	1200.0 (545.00)
600 VAC INPUT, 208Y/120 VAC OUTPUT, 60 HZ				
20	63TDA320	600	208Y/120	600.0 (273.00)
30	63TDA330	600	208Y/120	750.0 (341.00)
50	63TDA350	600	208Y/120	950.0 (432.00)
75	63TDA375	600	208Y/120	1200.0 (545.00)
Custom Voltages	240 Vac Input, 240Y/139 Vac Output, 60 Hz 480 Vac Input, 240Y/139 Vac Output, 60 Hz 600 Vac Input, 240Y/139 Vac Output, 60 Hz			

Contact Technical Services at (800) 377-4384 for custom voltages.

PROTECTION SPECIFICATIONS

Under Voltage	Output voltage will switch to bypass mode when input is less than 50% of nominal. Regulated output voltage will be re-established once input voltage is with specifications.
Short Circuit Protection	Input circuit breaker
Over Temperature Protection	Amber lamp indication of over temperature at approximately 180°C. Unit switches to by-pass mode until internal temperature is reduced to specified values.

NOISE SUPPRESSION PERFORMANCE SPECIFICATIONS

Common Mode Noise Attenuation	150 dB at 100 kHz
Normal Mode Noise Attenuation	65 dB at 100 kHz
Surge Protection	Tested to ANSI/IEEE standard C62.41 A&B

DESIGN STYLE

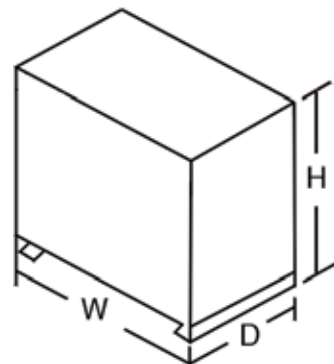

Emerson brings integrated manufacturing solutions to diverse industries worldwide. Our comprehensive product line, extensive experience, world-class engineering and global presence enable us to implement solutions that give our customers the competitive edge. SolaHD is our premium line of power-conversion and power quality solutions products.

For over 150 years, our electrical product brands have been providing a rich tradition of long-term, practical, high quality solutions with applications ranging from the construction and safe operation of petrochemical and process plants to providing quality power that precisely controls automotive robotic production.

Engineers, distributors, contractors, electricians and site maintenance professionals around the world trust Emerson brands to make electrical installations safer, more productive and more reliable.

The Appleton Group business unit of Emerson is organized into three focused groups that provide distributors and end users expert knowledge and excellent service.

Electrical Construction Materials

This group is made up of the Appleton and O-Z/Gedney brands. They manufacture a broad range of electrical products including conduit and cable fittings, plugs and receptacles, enclosures and controls, conduit bodies and industrial and hazardous lighting. Whether the application is hazardous location, industrial or commercial, the electrical construction materials group has the products to meet your needs.

Power Quality Solutions

The SolaHD brand offers the broadest power quality line, including uninterruptible power supplies, power conditioners, voltage regulators, shielded transformers, surge protection devices and power supplies.

Heating Cable Systems

This group is made up of the EasyHeat and Nelson brands. They offer a broad range of electrical heating cable products for residential, commercial and industrial applications.

Asia/Pacific
+ 65.6556.1100

Australia
+ 61.3.9721.0348

Canada
+ 1.888.765.2226

China
+ 86.21.3338.7000

Europe
+ 33.3.22.54.13.90

Mexico/Latin America
+ 52.55.5809.5049

Middle East/Africa/India
+ 971.4.811.8100

United States
+ 1.800.621.1506

Appleton Group
9377 W. Higgins Road
Rosemont, IL 60018
1.800.377.4384
solahd.com

SOLAHD

Appleton Grp LLC d/b/a Appleton Group. EasyHeat, Inc. is a wholly owned subsidiary of Appleton Grp LLC.
All other product or service names are the property of their registered owners. © 2016, Appleton Grp LLC. All rights reserved.
The Emerson logo is a trademark and a service mark of Emerson Electric Co. ©2016, Emerson Electric Co.



EMERSON. CONSIDER IT SOLVED.™