

Mitutoyo

Digital ABS Caliper CoolantProof IP67

0-150mm

Item number: 500-706-20



Description

These robust calipers allow reliable measurements in a wide range of situations.

The ABSOLUTE Digimatic Caliper IP67 offers you the following benefits:

- Excellent resistance against water and dust (IP67 protection level) enabling use in machining situations that include splashing coolant fluid.
- Dustproof, complies with EN60529 withstands temporary complete immersion in water without suffering any damage
- Extraordinarily long battery life.

Features

Range: 0 - 150 mm
Depth bar: flat
Mass: 164 g
Accuracy: ≤ 200 mm : ±0,02 mm > 200 mm : ±0,03 mm (excluding quantizing error)
Digital step: 0,01 mm
Max. response speed: Unlimited
Battery life: approx. 5 years (150 mm ,200 mm)5000 hours (300 mm)
Display: LCD, Character Height 9 mm (150, 200 mm) 10,2 mm (300 mm)
Delivered: In a case, including 1 battery
ORIGIN (ABS-Zero): Yes
Auto Power OFF after 20 min. non use: Yes
Low voltage alarm: Yes
Digital/Analog: Digital
Inch-Metric: Metric
Functions: Without thumb roller

Dimensions

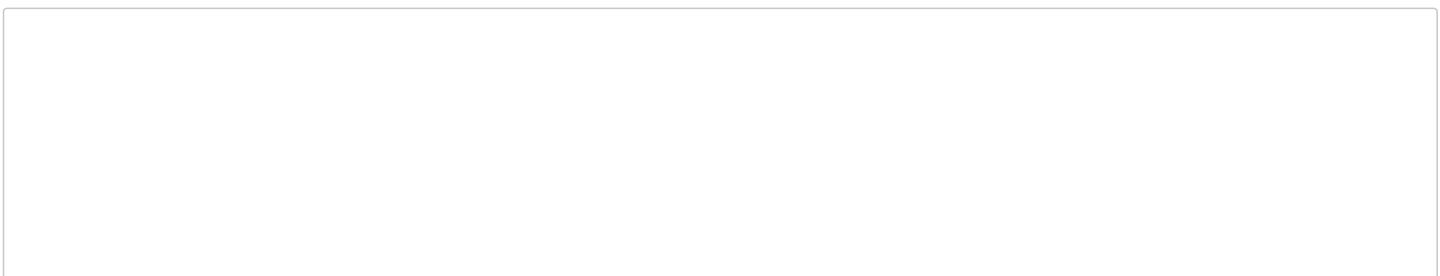

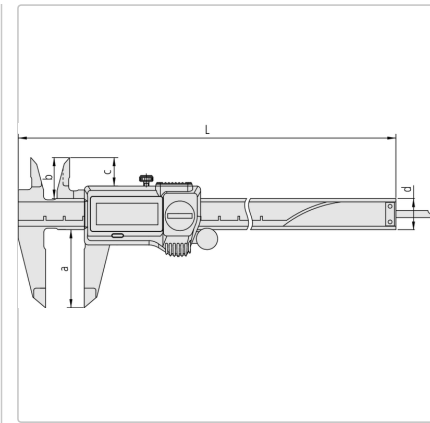

L: 233 mm

a: 40 mm







b: 21 mm

c: 16.5 mm

d: 16 mm

Accessories

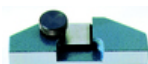
Optional accessories:

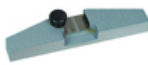
Product	Price
 Digimatic Cable with Data Button IP Type 1m, Caliper Type 05CZA624	Price on application
 Digimatic Cable with Data Button IP Type 2m, Caliper Type 05CZA625	Price on application
 U-WAVE T Connection Cable A with Data Button IP Caliper Type 02AZD790A	Suggested retail price: 97.00 €*
 USB Input Tool Direct (Digimatic USB) with Data Button IP Caliper Type 06AFM380A	Suggested retail price: 119.00 €*
 Depth Base Attachment for Caliper, 75mm width for 100, 150, 200mm range 050083-10	Suggested retail price: 47.00 €*
 Depth Base Attachment for Caliper, 100 mm width for 100mm, 100, 150, 200mm range 050084-10	Suggested retail price: 52.00 €*
 Depth Base Attachment for Caliper, 125 mm width for 300mm range 050085-10	Suggested retail price: 59.00 €*

Consumable spares:

Product	Price

Product	Price	
 SR44 1.5V NO. 938882 Mitsuboshi SR44 1.5V NO. 938882	Battery SR44 1.5V 938882	Price on application