

Description

- Industry standard SMD package with 5.5mm lead spacing
Suitable for real time clock applications
Plastic encapsulated
- Model 85SMX
- Model Issue number 9

Frequency Parameters

- Frequency 32.7680kHz
- Frequency Tolerance $\pm 30.00\text{ppm}$
- Frequency Stability $\pm 160.00\text{ppm}$
- Operating Temperature Range -20.00 to 70.00°C
- Overtone Order Fundamental
- Ageing $\pm 5\text{ppm}$ max per year @ 25°C

Electrical Parameters

- Load Capacitance (CL) 12.50pF
- Shunt Capacitance (C0) 1pF typ
- Drive Level 1.0 μW max
- ESR 50.00k Ω max

Environmental Parameters

- Storage Temperature Range: -55 to 125°C
- Drop: 75cm drop (3 times) onto hard wooden board
- Vibration: 1.5mm amplitude, 10Hz-60Hz, 2-3mins in 3 mutually perpendicular planes, duration 2hrs each plane

Manufacturing Details

- Not suitable for use with ultrasonic cleaning techniques

Compliance

- RoHS Status (2011/65/EU) Compliant
- REACH Status Compliant
- MSL Rating (JDEC-STD-033): Not Applicable

Packaging Details

- Pack Style: Reel Tape & reel in accordance with EIA-481-D
Pack Size: 3,000
- *Alternative packing option available*



Outline (mm)

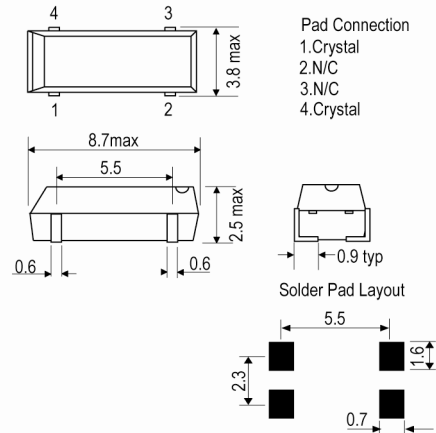

Typical Frequency Stability Characteristics

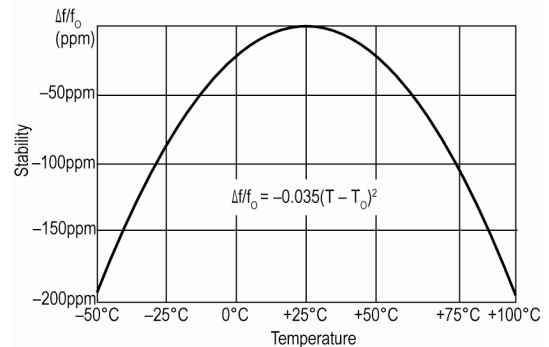

Sales Office Contact Details:

UK: +44 (0)1460 270200
Germany: 0800 1808 443

France: 0800 901 383
USA: +1.760.318.2824

Email: info@iqdfrequencyproducts.com
Web: www.iqdfrequencyproducts.com