

## PNOZ m EF 8DI4DO

**PILZ**  
THE SPIRIT OF SAFETY

- ▶ Configurable control systems PNOZmulti 2

This document is a translation of the original document.

All rights to this documentation are reserved by Pilz GmbH & Co. KG. Copies may be made for internal purposes. Suggestions and comments for improving this documentation will be gratefully received.

Pilz®, PIT®, PMI®, PNOZ®, Primo®, PSEN®, PSS®, PVIS®, SafetyBUS p®, SafetyEYE®, SafetyNET p®, the spirit of safety® are registered and protected trademarks of Pilz GmbH & Co. KG in some countries.



SD means Secure Digital

<b>Section 1</b>	<b>Introduction</b>	<b>4</b>
	1.1 Validity of documentation	4
	1.2 Using the documentation	4
	1.3 Definition of symbols	4
<b>Section 2</b>	<b>Overview</b>	<b>6</b>
	2.1 Scope of supply	6
	2.2 Unit features	6
	2.3 Front view	7
<b>Section 3</b>	<b>Safety</b>	<b>8</b>
	3.1 Intended use	8
	3.2 System requirements	8
	3.3 Safety regulations	8
	3.3.1 Use of qualified personnel	8
	3.3.2 Warranty and liability	9
	3.3.3 Disposal	9
	3.3.4 For your safety	9
<b>Section 4</b>	<b>Function description</b>	<b>10</b>
	4.1 Integrated protection mechanisms	10
	4.2 Functions	10
	4.3 System reaction time	10
	4.4 Block diagram	10
<b>Section 5</b>	<b>Installation</b>	<b>11</b>
	5.1 General installation guidelines	11
	5.2 Dimensions in mm	11
	5.3 Connecting the base unit and expansion modules	11
<b>Section 6</b>	<b>Commissioning</b>	<b>13</b>
	6.1 General wiring guidelines	13
	6.2 Connection	13
	6.3 Download modified project to the PNOZmulti system	14
<b>Section 7</b>	<b>Operation</b>	<b>16</b>
	7.1 Messages	16
<b>Section 8</b>	<b>Technical details</b>	<b>17</b>
	8.1 Safety characteristic data	19
<b>Section 9</b>	<b>Supplementary data</b>	<b>21</b>
	9.1 Permitted ambient temperature $T_{amb}$ dependent on the total current $I_{sum}$	21
<b>Section 10</b>	<b>Order reference</b>	<b>22</b>
	10.1 Product	22
	10.2 Accessories	22

# 1 Introduction

## 1.1 Validity of documentation

This documentation is valid for the product PNOZ m EF 8DI4DO. It is valid until new documentation is published.

This operating manual explains the function and operation, describes the installation and provides guidelines on how to connect the product.

## 1.2 Using the documentation

This document is intended for instruction. Only install and commission the product if you have read and understood this document. The document should be retained for future reference.

## 1.3 Definition of symbols

Information that is particularly important is identified as follows:



### **DANGER!**

This warning must be heeded! It warns of a hazardous situation that poses an immediate threat of serious injury and death and indicates preventive measures that can be taken.



### **WARNING!**

This warning must be heeded! It warns of a hazardous situation that could lead to serious injury and death and indicates preventive measures that can be taken.



### **CAUTION!**

This refers to a hazard that can lead to a less serious or minor injury plus material damage, and also provides information on preventive measures that can be taken.



### **NOTICE**

This describes a situation in which the product or devices could be damaged and also provides information on preventive measures that can be taken. It also highlights areas within the text that are of particular importance.

**INFORMATION**

This gives advice on applications and provides information on special features.

## 2 Overview

### 2.1 Scope of supply

- ▶ Expansion module PNOZ m EF 8DI4DO
- ▶ Jumper

### 2.2 Unit features

Using the product PNOZ m EF 8DI4DO:

Expansion module for connection to a base unit from the configurable control system PNOZmulti 2 .

The product has the following features:

- ▶ Can be configured in the PNOZmulti Configurator
- ▶ Semiconductor outputs:
  - 4 safety outputs
  - Depending on the application, up to PL e of EN ISO 13849-1 and up to SIL CL 3 of EN IEC 62061
- ▶ 8 inputs for connecting, for example:
  - E-STOP pushbutton
  - Two-hand button
  - Safety gate limit switch
  - Start button
  - Light beam devices
  - Scanner
  - Enabling switch
  - PSEN
  - Operating mode selector switch
- ▶ LED for:
  - Error messages
  - Diagnostics
  - Supply voltage
  - Output circuits
  - Input circuits
- ▶ Test pulse outputs used to monitor shorts across the inputs
- ▶ Monitoring of shorts between the safety outputs
- ▶ Plug-in connection terminals:
  - Either spring-loaded terminal or screw terminal available as an accessory (see order reference)
- ▶ Please refer to the document "PNOZmulti System Expansion" for the PNOZmulti base units that can be connected.

## 2.3 Front view

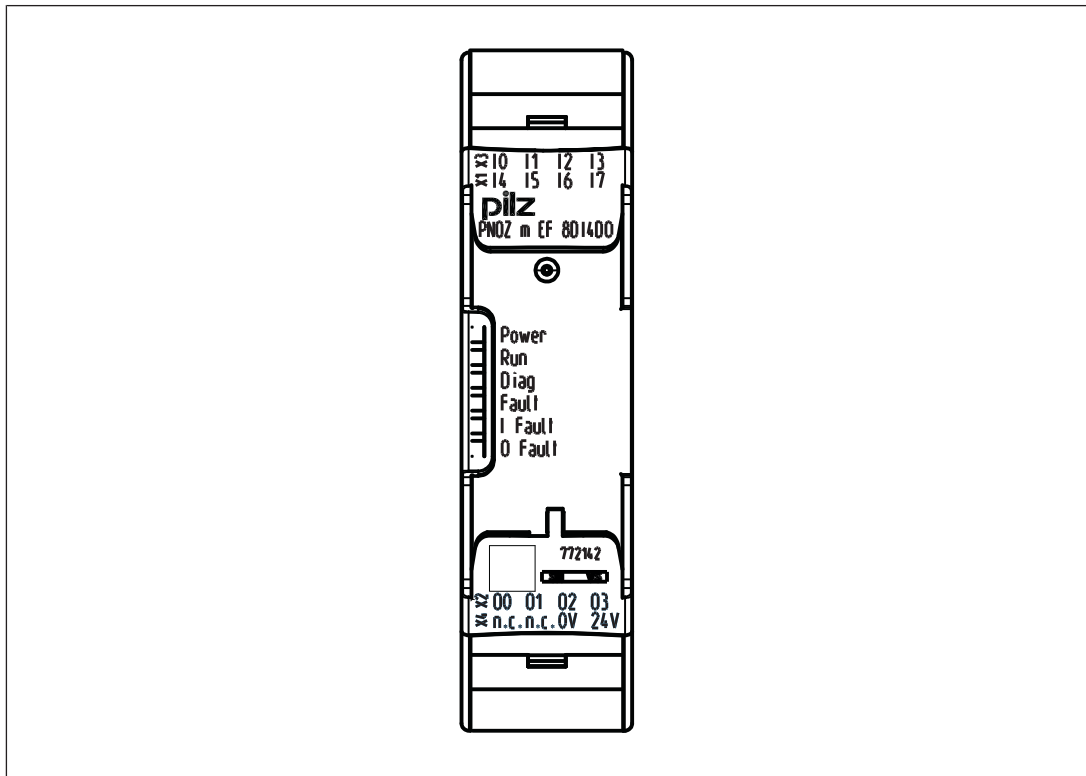

Key:

- ▶ 0 V, 24 V: Supply connections
- ▶ Inputs I0 – I7
- ▶ Outputs O0 – O3
- ▶ LEDs:
  - POWER
  - Run
  - Diag
  - Fault
  - I Fault
  - O Fault

## 3 Safety

### 3.1 Intended use

The expansion module may only be connected to a base unit from the configurable system PNOZmulti 2 (please refer to the document "PNOZmulti System Expansion" for details of the base units that can be connected).

The configurable system PNOZmulti 2 is used for the safety-related interruption of safety circuits and is designed for use in:

- ▶ Emergency stop equipment
- ▶ Safety circuits in accordance with VDE 0113 Part 1 and EN 60204-1

The following is deemed improper use in particular:

- ▶ Any component, technical or electrical modification to the product
- ▶ Use of the product outside the areas described in this manual
- ▶ Use of the product outside the technical details (see [Technical details](#) [ 17]).



#### NOTICE

##### EMC-compliant electrical installation

The product is designed for use in an industrial environment. The product may cause interference if installed in other environments. If installed in other environments, measures should be taken to comply with the applicable standards and directives for the respective installation site with regard to interference.

### 3.2 System requirements

Please refer to the "Product Modifications PNOZmulti" document in the "Version overview" section for details of which versions of the base unit and PNOZmulti Configurator can be used for this product.

### 3.3 Safety regulations

#### 3.3.1 Use of qualified personnel

The products may only be assembled, installed, programmed, commissioned, operated, maintained and decommissioned by competent persons.

A competent person is someone who, because of their training, experience and current professional activity, has the specialist knowledge required to test, assess and operate the work equipment, devices, systems, plant and machinery in accordance with the general standards and guidelines for safety technology.

It is the company's responsibility only to employ personnel who:

- ▶ Are familiar with the basic regulations concerning health and safety / accident prevention
- ▶ Have read and understood the information provided in this description under "Safety"



- ▶ And have a good knowledge of the generic and specialist standards applicable to the specific application.

### 3.3.2 **Warranty and liability**

All claims to warranty and liability will be rendered invalid if

- ▶ The product was used contrary to the purpose for which it is intended
- ▶ Damage can be attributed to not having followed the guidelines in the manual
- ▶ Operating personnel are not suitably qualified
- ▶ Any type of modification has been made (e.g. exchanging components on the PCB boards, soldering work etc.).

### 3.3.3 **Disposal**

- ▶ When decommissioning, please comply with local regulations regarding the disposal of electronic devices (e.g. Electrical and Electronic Equipment Act).

### 3.3.4 **For your safety**

The unit meets all the necessary conditions for safe operation. However, you should always ensure that the following safety requirements are met:

- ▶ This operating manual only describes the basic functions of the unit. The expanded functions are described in the PNOZmulti Configurator's online help. Only use these functions once you have read and understood the documentations.
- ▶ Do not open the housing or make any unauthorised modifications.
- ▶ Please make sure you shut down the supply voltage when performing maintenance work (e.g. exchanging contactors).

## 4 Function description

### 4.1 Integrated protection mechanisms

The relay conforms to the following safety criteria:

- ▶ The circuit is redundant with built-in self-monitoring.
- ▶ The safety function remains effective in the case of a component failure.
- ▶ The safety outputs are tested periodically using a disconnection test.

### 4.2 Functions

The expansion module provides additional inputs and additional semiconductor outputs.

The function of the inputs and outputs on the control system depends on the safety circuit created using the PNOZmulti Configurator. A chip card is used to download the safety circuit to the base unit. The base unit has 2 microcontrollers that monitor each other. They evaluate the input circuits on the base unit and expansion modules and switch the outputs on the base unit and expansion modules accordingly.

The online help on the PNOZmulti Configurator contains descriptions of the operating modes and all the functions of the PNOZmulti control system, plus connection examples.

### 4.3 System reaction time

Calculation of the maximum reaction time between an input switching off and a linked output in the system switching off is described in the document "PNOZmulti System Expansion".

### 4.4 Block diagram

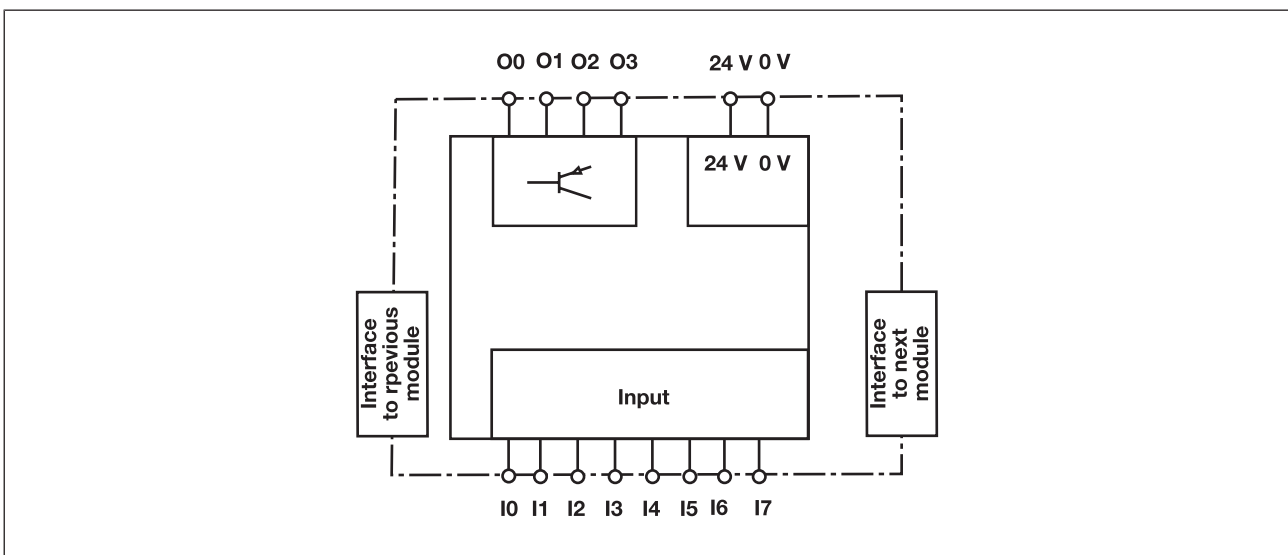

## 5 Installation

### 5.1 General installation guidelines

- ▶ The unit should be installed in a control cabinet with a protection type of at least IP54.
- ▶ Fit the safety system to a horizontal mounting rail. The venting slots must face upward and downward. Other mounting positions could damage the safety system.
- ▶ Use the locking elements on the rear of the unit to attach it to a mounting rail.
- ▶ In environments exposed to heavy vibration, the unit should be secured using a fixing element (e.g. retaining bracket or end angle).
- ▶ Open the locking slide before lifting the unit from the mounting rail.
- ▶ To comply with EMC requirements, the mounting rail must have a low impedance connection to the control cabinet housing.
- ▶ The ambient temperature of the PNOZmulti units in the control cabinet must not exceed the figure stated in the technical details, otherwise air conditioning will be required.



#### NOTICE

Damage due to electrostatic discharge!

Electrostatic discharge can damage components. Ensure against discharge before touching the product, e.g. by touching an earthed, conductive surface or by wearing an earthed armband.

### 5.2 Dimensions in mm

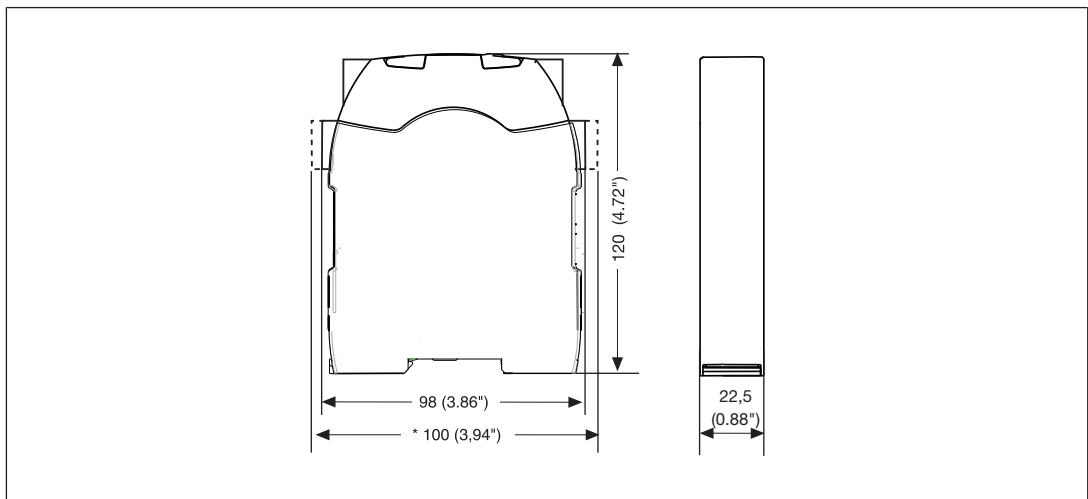

### 5.3 Connecting the base unit and expansion modules

Connect the base unit and the expansion modules as described in the operating manuals for the base modules.

- ▶ The terminator must be fitted to the last expansion module
- ▶ Install the expansion module in the position configured in the PNOZmulti Configurator.

The position of the expansion modules is defined in the PNOZmulti Configurator. The expansion modules are connected to the left or right of the base unit, depending on the type. Please refer to the document "PNOZmulti System Expansion" for details of the number of modules that can be connected to the base unit and the module types.

## 6 Commissioning

### 6.1 General wiring guidelines

The wiring is defined in the circuit diagram of the PNOZmulti Configurator.

Please note:

- ▶ Information given in the [Technical details](#) [17] must be followed.
- ▶ Use copper wire that can withstand 75° C.

### 6.2 Connection

Supply voltage	DC

Supply voltage

Input circuit	Single-channel	Dual-channel
Example: E-Stop without detection of shorts across contacts		
Example: E-Stop with detection of shorts across contacts		

Connection examples for the input circuit

<p>Redundant output</p>		
<p>Single output</p>		
<p>Single output with advanced fault detection*</p>		

Connection examples for semiconductor outputs

\*Two loads may be connected to each safety output with advanced fault detection, even on applications in accordance with EN IEC 62061, SIL CL 3. Prerequisite: Feedback loop is connected, shorts across contacts and external power sources are excluded (e.g. through separate multicore cables). Please note that, in the event of an error in the feedback loop, the safety system switches to a safe condition and shuts down **all** the outputs.

<p>Feedback loop</p>	<p>Redundant output</p>
<p>Contacts from external contactors</p>	

Connection examples for feedback loop

### 6.3 Download modified project to the PNOZmulti system

As soon as an additional expansion module has been connected to the system, the project must be amended using the PNOZmulti Configurator. Proceed as described in the operating instructions for the base unit.

**NOTICE**

For the commissioning and after every program change, you must check whether the safety devices are functioning correctly.



## 7 Operation

















When the supply voltage is switched on, the PNOZmulti safety system copies the configuration from the chip card.

The LEDs “POWER”, “DIAG”, “FAULT”, “IFAUULT” and “OFAULT” will light up on the base unit.

### 7.1 Messages

#### Legend

-  LED on
-  LED flashes
-  LED off

LED						Error
POWER	Run	Diag	Fault	IFault	OFault	
						No supply voltage
						Expansion module PNOZ m EF 8DI4DO running without error.
						Expansion module PNOZ m EF 8DI4DO is in a STOP condition.
						Internal error on the expansion module PNOZ m EF 8DI4DO or on the overall system. Expansion module is in a safe condition.
						External error on the expansion module PNOZ m EF 8DI4DO or on the overall system. Expansion module is in a safe condition.
						Internal error on the inputs of the expansion module PNOZ m EF 8DI4DO. Expansion module is in a safe condition, e.g. pulse error.
						Internal error on the outputs of the expansion module PNOZ m EF 8DI4DO. Expansion module is in a safe condition.
						External error on the inputs of the expansion module PNOZ m EF 8DI4DO. Expansion module is in a safe condition.
						External error on the outputs of the expansion module PNOZ m EF 8DI4DO. Expansion module is in a safe condition, e.g. defective feedback loop.



## 8 Technical details

<b>General</b>	
Approvals	<b>BG, CCC, CE, GOST, TÜV, cULus Listed</b>
Application range	<b>Failsafe</b>
Module's device code	<b>00E0h</b>
<b>Electrical data</b>	
Supply voltage	
for	<b>Supply to the SC outputs</b>
Voltage	<b>24 V</b>
Kind	<b>DC</b>
Voltage tolerance	<b>-20 %/+25 %</b>
Current load capacity at UB	<b>8,0 A</b>
Potential isolation	<b>yes</b>
Supply voltage	
for	<b>Module supply</b>
internal	<b>Via base unit</b>
Voltage	<b>24,0 V</b>
Kind	<b>DC</b>
Current consumption	<b>39 mA</b>
Power consumption	<b>1,0 W</b>
Max. power dissipation of module	<b>4,50 W</b>
Status indicator	<b>LED</b>
Permitted loads	<b>inductive, capacitive, resistive</b>
<b>Inputs</b>	
Number	<b>8</b>
Input voltage in accordance with EN 61131-2 Type 1	<b>24 V DC</b>
Input current at rated voltage	<b>5 mA</b>
Input current range	<b>2,5 - 5,3 mA</b>
Pulse suppression	<b>0,5 ms</b>
Maximum input delay	<b>8 ms</b>
Potential isolation	<b>No</b>
<b>Semiconductor outputs</b>	
Number of positive-switching single-pole semiconductor outputs	<b>4</b>
Switching capability	
Voltage	<b>24 V</b>
Typ. output current at "1" signal and rated voltage of semiconductor output	<b>2,00 A</b>
Permitted current range	<b>0,00 - 2,50 A</b>
Residual current at "0" signal	<b>0,05 mA</b>
Max. transient pulsed current	<b>12 A</b>
Max. capacitive load	<b>1 µF</b>
Max. internal voltage drop	<b>500 mV</b>
Max. duration of off time during self test	<b>330 µs</b>
Switch-off delay	<b>3 ms</b>

<b>Semiconductor outputs</b>	
Potential isolation	yes
Short circuit-proof	yes
<b>Environmental data</b>	
Ambient temperature	
In accordance with the standard	EN 60068-2-14
Temperature range	0 - 60 °C
Forced convection in control cabinet off	55 °C
Storage temperature	
In accordance with the standard	EN 60068-2-1/-2
Temperature range	-25 - 70 °C
Climatic suitability	
In accordance with the standard	EN 60068-2-30, EN 60068-2-78
Condensation during operation	Not permitted
EMC	EN 61131-2
Vibration	
In accordance with the standard	EN 60068-2-6
Frequency	5,0 - 150,0 Hz
Acceleration	1g
Shock stress	
In accordance with the standard	EN 60068-2-27
Acceleration	15g
Duration	11 ms
Max. operating height above sea level	2000 m
Airgap creepage	
In accordance with the standard	EN 61131-2
Overvoltage category	II
Pollution degree	2
Rated insulation voltage	30 V
Protection type	
In accordance with the standard	EN 60529
Mounting area (e.g. control cabinet)	IP54
Housing	IP20
Terminals	IP20
<b>Potential isolation</b>	
Potential isolation between	SC output and system voltage
Type of potential isolation	Basic insulation
Rated surge voltage	2500 V
<b>Mechanical data</b>	
Mounting position	Horizontal on top hat rail
DIN rail	
Top hat rail	35 x 7,5 EN 50022
Recess width	27 mm
Max. cable length	
Max. cable length per input	1,0 km

<b>Mechanical data</b>	
Material	
Bottom	PC
Front	PC
Top	PC
Connection type	Spring-loaded terminal, screw terminal
Mounting type	plug-in
Conductor cross section with screw terminals	
1 core flexible	0,25 - 2,50 mm <sup>2</sup> , 24 - 12 AWG
2 core with the same cross section, flexible without crimp connectors or with TWIN crimp connectors	0,20 - 1,50 mm <sup>2</sup> , 24 - 16 AWG
Torque setting with screw terminals	0,50 Nm
Conductor cross section with spring-loaded terminals: Flexible with/without crimp connector	0,20 - 2,50 mm <sup>2</sup> , 24 - 12 AWG
Spring-loaded terminals: Terminal points per connection	2
Stripping length with spring-loaded terminals	9 mm
Dimensions	
Height	101,4 mm
Width	22,5 mm
Depth	120,0 mm
Weight	105 g

Where standards are undated, the 2012-04 latest editions shall apply.

## 8.1 Safety characteristic data



### NOTICE

You must comply with the safety-related characteristic data in order to achieve the required safety level for your plant/machine.

Unit	Operating mode	EN ISO 13849-1: 2008 PL	EN ISO 13849-1: 2008 Category	EN 62061 SIL CL	EN 62061 PFH <sub>D</sub> [1/h]	EN ISO 13849-1: 2008 T <sub>M</sub> [year]
<b>Logic</b>						
CPU	–	PL e	Cat. 4	SIL CL 3	2,84E-10	20
<b>Input</b>						
SC inputs	1-channel	PL d	Cat. 2	SIL CL 2	2,10E-09	20
SC inputs	2-channel	PL e	Cat. 4	SIL CL 3	4,27E-11	20
SC inputs	1-ch., pulsed light barrier	PL e	Cat. 4	SIL CL 3	2,10E-10	20

Output						
SC outputs	<b>1-channel with advanced fault detection</b>	<b>PL e</b>	<b>Cat. 4</b>	<b>SIL CL 3</b>	<b>2,12E-11</b>	<b>20</b>
SC outputs	<b>1-channel</b>	<b>PL d</b>	<b>Cat. 2</b>	<b>SIL CL 2</b>	<b>2,29E-10</b>	<b>20</b>
SC outputs	<b>2-channel</b>	<b>PL e</b>	<b>Cat. 4</b>	<b>SIL CL 3</b>	<b>1,64E-10</b>	<b>20</b>

All the units used within a safety function must be considered when calculating the safety characteristic data.



**INFORMATION**

A safety function's SIL/PL values are **not** identical to the SIL/PL values of the units that are used and may be different. We recommend that you use the PAScal software tool to calculate the safety function's SIL/PL values.

## 9 Supplementary data

### 9.1 Permitted ambient temperature $T_{amb}$ dependent on the total current $I_{sum}$

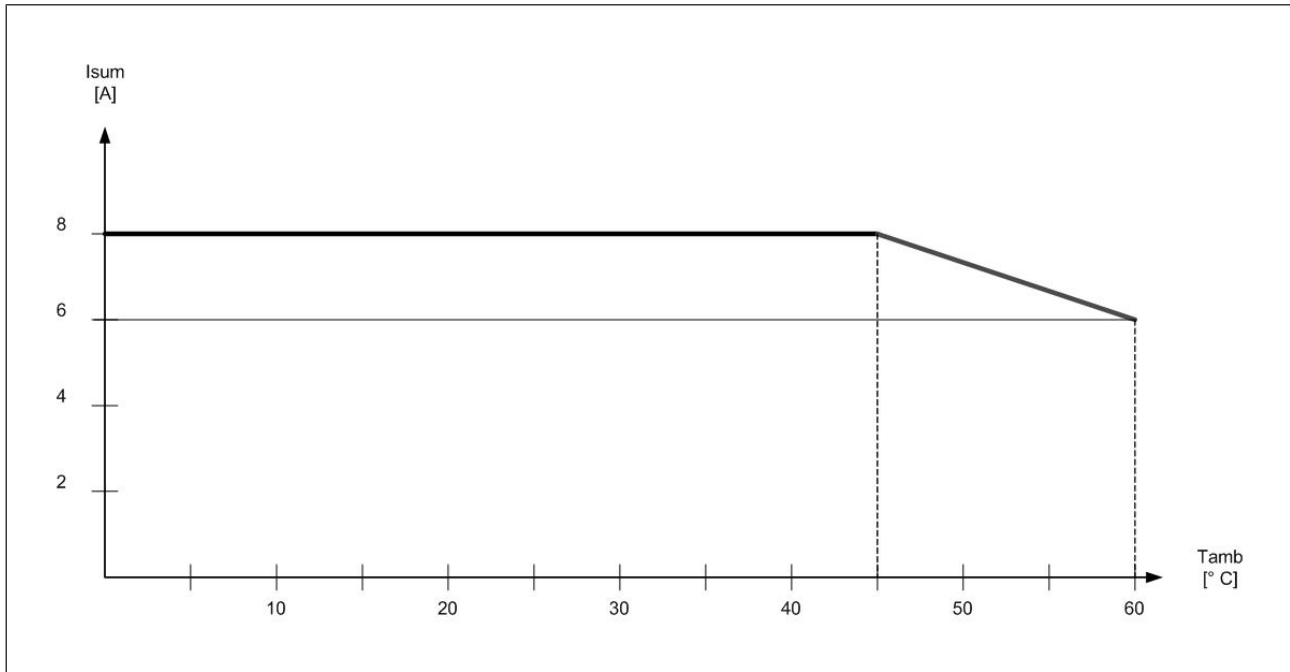

## 10 Order reference

### 10.1 Product

Product type	Features	Order No.
PNOZ m EF 8DI4DO	Expansion module	772 142

### 10.2 Accessories

#### Connection terminals

Product type	Features	Order No.
Set spring terminals	1 set of spring-loaded terminals	751 004
Set screw terminals	1 set of screw terminals	750 004

#### Terminator, jumper

Product type	Features	Order No.
PNOZ mm0.xp connector left	Jumper yellow/black to connect the modules, 10 piece	779 260

# ► Support

Technical support is available from Pilz round the clock.

## Americas

**Brazil**  
+55 11 97569-2804

**Canada**  
+1 888-315-PILZ (315-7459)

**Mexico**  
+52 55 5572 1300

**USA (toll-free)**  
+1 877-PILZUSA (745-9872)

## Asia

**China**  
+86 21 60880878-216

**Japan**  
+81 45 471-2281

**South Korea**  
+82 31 450 0680

## Australia

+61 3 95446300

## Europe

**Austria**  
+43 1 7986263-0

**Belgium, Luxembourg**  
+32 9 3217575

**France**  
+33 3 88104000

**Germany**  
+49 711 3409-444

**Ireland**  
+353 21 4804983

**Italy**  
+39 0362 1826711

## Scandinavia

+45 74436332

## Spain

+34 938497433

## Switzerland

+41 62 88979-30

## The Netherlands

+31 347 320477

## Turkey

+90 216 5775552

## United Kingdom

+44 1536 462203

## You can reach our international hotline on:

+49 711 3409-444  
support@pilz.com

Pilz develops environmentally-friendly products using ecological materials and energy-saving technologies. Offices and production facilities are ecologically designed, environmentally-aware and energy-saving. So Pilz offers sustainability, plus the security of using energy-efficient products and environmentally-friendly solutions.

*Energy saving by Pilz*



Pilz GmbH & Co. KG  
Felix-Wankel-Straße 2  
73760 Ostfildern, Germany  
Tel.: +49 711 3409-0  
Fax: +49 711 3409-133  
info@pilz.com  
www.pilz.com

**PILZ**  
THE SPIRIT OF SAFETY