

 adafruit learning system

## TV-B-Gone Kit

Created by lady ada

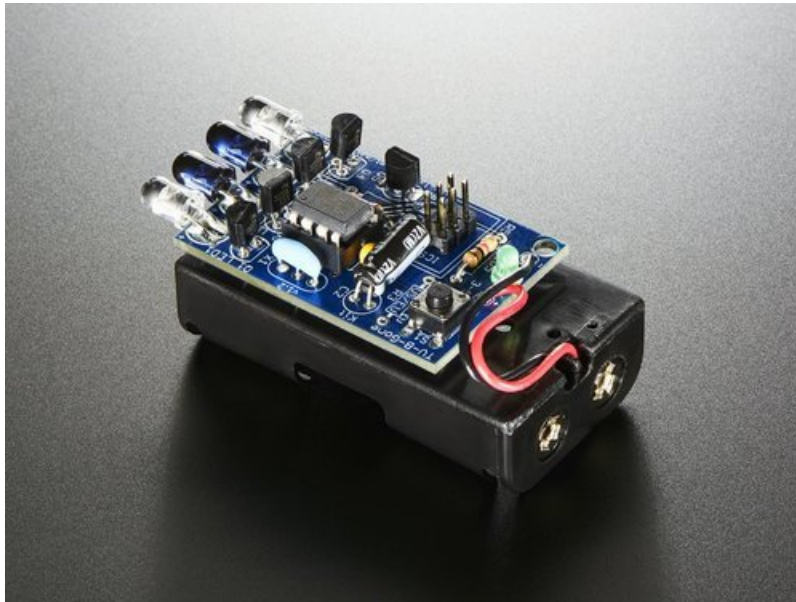

Last updated on 2018-01-04 09:54:02 PM UTC

## Guide Contents

Guide Contents	2
Overview	4
Make every day a "TV-free" day!"	4
See it in use!	4
Specifications	5
Credits	5
F.A.Q.	6
What is a TV-B-Gone Kit?	6
How are the kit and original TV-B-Gone product related?	6
Why should I get a kit if I can just buy a TV-B-Gone ready made?	6
Does this kit work on all TVs?	6
Does this kit work with European TVs?	6
How close do I have to be for the TV-B-Gone kit to work?	6
I'm not able to turn off the TV from more than 30 feet away, what's wrong?	6
The LEDs blink as soon as I put in batteries, is this normal?	6
When I press the button, the LEDs stop blinking, is this normal?	6
How do I get the TV-B-Gone to turn off?	7
The LEDs blink for 2 seconds or less, then turn off, whats wrong?	7
I want more range! How can I make the kit more powerful?	7
How can I reprogram the TV-B-Gone kit?	7
Make it!	8
Get ready to make your kit	8
Ready?	8
Preparation	9
Tools	9
Parts list	13
V1.1 & V1.0 Kit Parts	14
Solder it!	15
Get Ready...	15
Go!	15
Test it!	39
Test 1	39
Test 2	39
Use it!	40
Very easy!	40
Video of recommended usage	40
Design Notes	41
Design Notes	41
Power supply	41
IR LEDs	41
Button	41
Crystal	41
IR-Driver Transistors	41
IR-Driver-Transistors-Driver Transistor	42
Example of a single IR code	43
Code compression in v1.2	49

Download	55
Download files for the kit designs	55
Files for v1.2 PCB (and matching firmware)	55
Files for v1.1 PCB	55
Files for v1.0 PCB	56
Buy Kit	57
Forums	58

## Overview

Make every day a "TV-free" day!"

---



Tired of all those LCD TVs everywhere?  
Want a break from advertisements while you're trying to eat?  
Want to zap screens from across the street?

The new Universal TV-B-Gone kit is what you need! This ultra-high-power version of the popular TV-B-Gone is fun to make and even more fun to use.

Built in co-operation with [Mitch Altman \(the inventor of the TV-B-Gone\)](#) this kit is a great way to build something truly *useful!*

See it in use!



## Specifications

- Power: 2 AA batteries
- Output: 2 narrow-beam and 2 wide-beam IR LEDs
- Number of TV codes: 230 total codes, 115 for 'North America' and 115 for "Europe" This covers pretty much every TV of the following brands, including the latest flat-screens and plasma TVs **Acer, Admiral, Aiko, Alleron, Anam National, AOC, Apex, Baur, Bell&Howell, Brillian, Bush, Candle, Citizen, Contec, Cony, Crown, Curtis Mathes, Daiwoo, Dimensia, Electrograph, Electrohome, Emerson, Fisher, Fujitsu, Funai, Gateway, GE, Goldstar, Grundig, Grunpy, Hisense, Hitachi, Infinity, JBL, JC Penney, JVC, LG, Logik, Loewe, LXI, Majestic, Magnavox, Marantz, Maxent, Memorex, Mitsubishi, MGA, Montgomery Ward, Motorola, MTC, NEC, Neckermann, NetTV, Nikko, NTC, Otto Versand, Palladium, Panasonic, Philco, Philips, Pioneer, Portland, Proscan, Proton, Pulsar, Pye, Quasar, Quelle, Radio Shack, Realistic, RCA, Samsung, Sampo, Sansui, Sanyo, Scott, Sears, SEI, Sharp, Signature, Simpson, Sinudyne, Sonolor, Sony, Soundesign, Sylviana, Tatum, Teknika, Thompson, Toshiba, Universum, Viewsonic, Wards, White Westinghouse, Zenith**
- Max distance: ~~more than 100 ft~~ **New!** v1.2 of the kit is twice as powerful, 150 feet or more!
- Satisfaction: guaranteed!

## Credits

This kit was a successful collaboration with [Cornfield Electronics](#)!



## F.A.Q.

---

### What is a TV-B-Gone Kit?

[TV-B-Gone](#) is a 'universal' remote control device, it is basically like a remote control but with only the "Power" button. This is a kit version of that product.

### How are the kit and original TV-B-Gone product related?

[Mitch Altman](#) (inventor of the TV-B-Gone) and his company [Cornfield Electronics](#) worked together with me (Adafruit Industries) to develop a kit version of the TV-B-Gone. Mitch thinks open source kits are awesome!

### Why should I get a kit if I can just buy a TV-B-Gone ready made?

This kit is for learning how to solder and maybe even a little of how remote controls are designed. The kit version also has 2 AA batteries and 4 high power output IR LEDs to allow for much longer distances than the keychain product, more than 150 ft! It's also easier to hack and adapt for other projects. However, the kit has fewer codes (so there may find a TV once in a while that doesn't respond), is larger and heavier and requires you to put it together.

We suggest you get one of each!

### Does this kit work on all TVs?

The latest revision of the kit (v1.2) has 230 of the most common codes for TV's! We couldn't include every code, but field testing has shown that nearly every TV we encountered would turn off, even the most recent LCD and Plasma flat screen TVs!

Note that this kit will not work with LED signs, computer monitors (that are not also televisions) and display signs that don't have a remote-control port.

### Does this kit work with European TVs?

IF you have v1.1 or v1.0 kit (older) it is designed for "North American/Asia" only. A large number of newer European TVs will work with TV-B-Gone kit, but its not as likely. For example, instead of 90% success, its more like 50%

The v1.2 kit can be configured for either N.A. and EU zone which avoids this problem!

### How close do I have to be for the TV-B-Gone kit to work?

The closer the better, but we've found that if you have pretty good aim, you can be 100' (30m) or farther.

### I'm not able to turn off the TV from more than 30 feet away, what's wrong?

First, [perform the test to make sure all 4 IR LEDs are firing](#).

Second, make sure you have fresh Alkaline batteries installed

Third, try to aim as best as you can at the IR receiver, usually a small dark plastic plate on the front of the TV

Finally, try many different TVs. Some TVs simply do not respond as well from far away as others.

### The LEDs blink as soon as I put in batteries, is this normal?

Yes! The kit will turn on when you insert batteries or if you press the button.

### When I press the button, the LEDs stop blinking, is this normal?

Yes, the button is used to reset the kit, so if its pressed, the kit is off. When you release it, it turns on and blasts the TV-b-gone codes!

### How do I get the TV-B-Gone to turn off?

The TV-B-Gone turns itself off once it is done with all the codes. This takes about 2 minutes! If you press the button, it will just start over so don't do that if you want it to stop. There is no off switch button, just put the kit in your pocket and it will turn itself off when it is done.

### The LEDs blink for 2 seconds or less, then turn off, whats wrong?

You need to replace your batteries. Get FRESH Alkaline batteries, don't use old batteries from the back of your desk!

### I want more range! How can I make the kit more powerful?

Make sure you have fresh Alkaline batteries. They work better than rechargables

You can swap out the 2 AA battery holder for a 3 AA battery holder. This will give even better performance! Using C or D cell batteries will give longer run time but won't increase the power.

**Do not use 9V batteries** or more than 3 1.5V alkaline batteries, you can permanently damage the kit!

Coin cells do not work at all, don't bother using them.

### How can I reprogram the TV-B-Gone kit?

Because of the limited number of pins and other elements of the kit, programming the kit requires a little modification. For the latest version, removing **R1** 1.0k resistor (or cutting one side) will allow it to be programmed.

For earlier kits, unfortunately, all four 47 ohm resistors must be removed (or one side cut).

## Make it!

### Get ready to make your kit

---

#### Ready?

This is a vey easy kit to make, just go through each of these steps to build the kit:

1. [Tools and preparation](#)
2. [Check the parts list](#)
3. [Assemble the kit](#)
4. [Test the assembled kit!](#)



## Preparation

---

[Learn how to solder with tons of tutorials!](#)

[Don't forget to learn how to use your multimeter too!](#)

### Tools

There are a few tools that are required for assembly. None of these tools are included. If you don't have them, now would be a good time to borrow or purchase them. They are very very handy whenever assembling/fixing/modifying electronic devices! I provide links to buy them, but of course, you should get them wherever is most convenient/inexpensive. Many of these parts are available in a place like Radio Shack or other (higher quality) DIY electronics stores.

---

#### Soldering iron

Any entry level 'all-in-one' soldering iron that you might find at your local hardware store should work. As with most things in life, you get what you pay for.

Upgrading to a higher end soldering iron setup, like the [Hakko FX-888 that we stock in our store \(http://adafru.it/180\)](http://adafru.it/180), will make soldering fun and easy.

Do not use a "ColdHeat" soldering iron! They are not suitable for delicate electronics work and can damage the kit ([see here \(https://adafru.it/aOo\)](https://adafru.it/aOo)).

[Click here to buy our entry level adjustable 30W 110V soldering iron \(http://adafru.it/180\)](http://adafru.it/180).

[Click here to upgrade to a Genuine Hakko FX-888 adjustable temperature soldering iron. \(http://adafru.it/303\)](http://adafru.it/303)





## Solder

You will want rosin core, 60/40 solder. Good solder is a good thing. Bad solder leads to bridging and cold solder joints which can be tough to find.

[Click here to buy a spool of leaded solder \(recommended for beginners\) \(http://adafru.it/145\).](http://adafru.it/145)

[Click here to buy a spool of lead-free solder \(http://adafru.it/734\).](http://adafru.it/734)



## Multimeter

You will need a good quality basic multimeter that can measure voltage and continuity.

[Click here to buy a basic multimeter. \(http://adafru.it/71\)](http://adafru.it/71)

[Click here to buy a top of the line multimeter. \(http://adafru.it/308\)](http://adafru.it/308)

[Click here to buy a pocket multimeter. \(http://adafru.it/850\)](http://adafru.it/850)





### Flush Diagonal Cutters

You will need flush diagonal cutters to trim the wires and leads off of components once you have soldered them in place.

[Click here to buy our favorite cutters \(http://adafru.it/152\).](http://adafru.it/152)



### Solder Sucker

Strangely enough, that's the technical term for this desoldering vacuum tool. Useful in cleaning up mistakes, every electrical engineer has one of these on their desk.

[Click here to buy a one \(http://adafru.it/148\).](http://adafru.it/148)

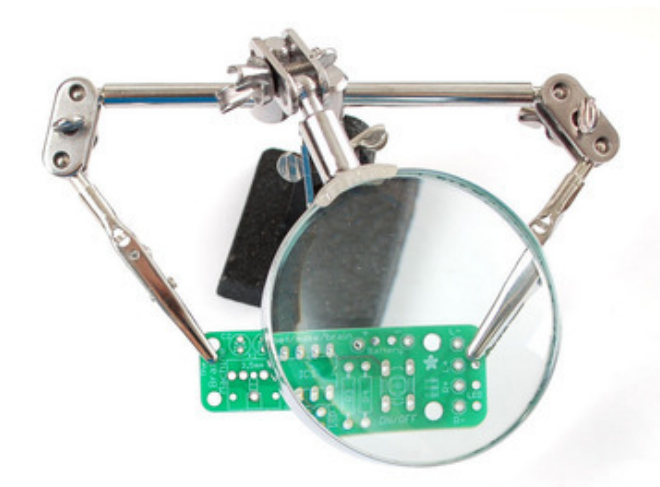

### Helping Third Hand With Magnifier













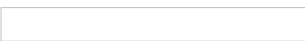
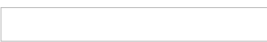

Not absolutely necessary but will make things go much faster, and it will make soldering much easier.

[Pick one up here \(http://adafru.it/291\).](http://adafru.it/291)

## Parts list

This is the parts list for v1.2 ONLY! If you have a v1.0 or v1.1 kit this list will be incorrect! See below for the v1.0/v1.1 parts list guide.















Check to make sure your kit comes with the following parts. Sometimes we make mistakes so double check everything and email [support@adafruit.com](mailto:support@adafruit.com) if you need replacements!

Image	Name	Description	More info	Qty
	IC1	Microcontroller (preprogrammed when purchased in a kit)	<a href="#">ATTINY85V-10-PU</a>  (unprogrammed when not purchased from Adafruit)	1
	IC1'	8-pin socket	<a href="#">Generic</a>	1
	XTL1	8.00 MHz ceramic oscillator. It might also be blue.	<a href="#">8mhz ceramic resonator</a>	1
	C2	220uF or higher capacitor with 6.3V or higher rating	<a href="#">Electrolytic Capacitor</a>	1
	C1	Ceramic 0.1uF capacitor (104)	<a href="#">Ceramic Capacitor</a>	1
	R3	1/4W 5% 10K resistor  For EU configuration use!  Brown, Black, Orange, Gold	<a href="#">Generic Resistor</a>	1
	R1, R5	1.0Kohm 1/4W 5% resistor (brown black red gold)	<a href="#">Generic Resistor</a>	2
	LED2, LED3	Narrow beam IR LED. These have a blue-ish tint.	Everlight <a href="#">IR333-A</a>	2
	LED1, LED4	Wide beam IR LED	Everlight <a href="#">IR333C/H0/L10</a>	2
	LED5	3mm LED	<a href="#">3mm green diffused</a>	1
	SW1	6mm tact switch button	<a href="#">6mm tact switch</a>	1
	Q5	PNP transistor, EBC pinout  Such as PN2907 or 2N3806	<a href="#">PN2907</a>	1
	Q1 Q2 Q3 Q4	NPN Transistor (TO-92) that is pin compatible with 2N3904 EBC pinout	<a href="#">PN2222</a>	4
	ICSP	6 pin header, 0.1"x0.1" spacing	<a href="#">2x3 header</a>	1
	BATT	2 x AA battery holder	<a href="#">Keystone 2463</a>	1
	PCB	Circuit board	<a href="#">Adafruit Industries</a>	1

## V1.1 & V1.0 Kit Parts

This is the parts list for v1.0 and v1.1 ONLY! If you have a v1.2 kit this list will be incorrect, see above for the correct parts list!

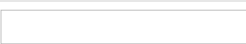
Check to make sure your kit comes with the following parts. Sometimes we make mistakes so double check everything and email [support@adafruit.com](mailto:support@adafruit.com) if you need replacements!

Image	Name	Description	Distributor	Qty
	IC1	Microcontroller (preprogrammed when purchased in a kit)	<a href="#">ATTINY85V-10-PU</a> (unprogrammed when not purchased from Adafruit)	1
	IC1'	8-pin socket	<a href="#">Generic</a>	1
	XTL1	8.00 MHz ceramic oscillator. It might also be blue.	<a href="#">8mhz ceramic resonator</a>	1
	C2	100uF or higher capacitor with 6.3V or higher rating	<a href="#">Electrolytic Capacitor</a>	1
	C1	Ceramic 0.1uF capacitor (104)	<a href="#">Ceramic Capacitor</a>	1
	R1-R4	47 ohm 1/4W 5% resistor (yellow violet black gold)	<a href="#">Generic Resistor</a>	4
	R5	1.0Kohm 1/4W 5% resistor (brown black red gold)	<a href="#">Generic Resistor</a>	1
	LED2, LED3	Narrow beam IR LED. These have a blue-ish tint.	Everlight <a href="#">IR333-A</a>	2
	LED1, LED4	Wide beam IR LED	Everlight <a href="#">IR333C/H0/L10</a>	2
	LED5	3mm LED	<a href="#">3mm green diffused</a>	1
	SW1	6mm tact switch button	<a href="#">6mm tact switch</a>	1
	Q1 Q2 Q3 Q4	NPN Transistor (TO-92) that is pin compatible with 2N3904	<a href="#">PN2222</a>	4
	JP2	10 pin box header	<a href="#">2x5 header</a>	1
	BATT	2 x AA battery holder	<a href="#">Keystone 2463</a>	1
	PCB	Circuit board	<a href="#">Adafruit Industries</a>	1

## Solder it!

---

### Get Ready...

The first step is to solder the kit together. If you've never soldered before, check the [Preparation page for tutorials and more](#).

These instructions are for v1.2 ONLY

[For older instructions, check this page!](#)

### Go!

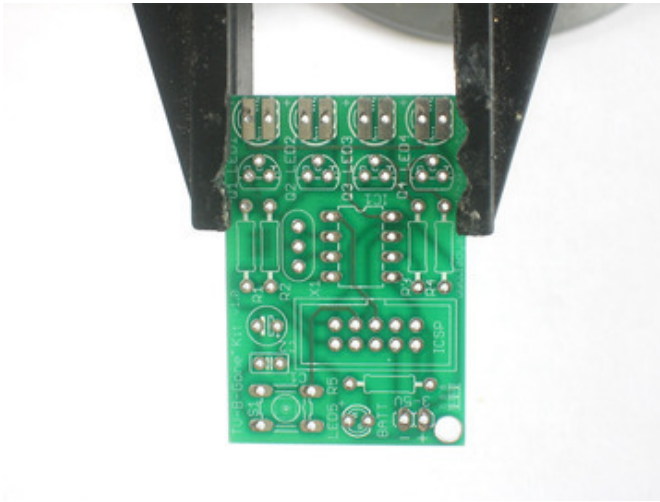

Check the kit against the [parts list \(https://adafruit.it/c5r\)](https://adafruit.it/c5r) to verify you have all the parts necessary.

Put the printed circuit board into a vise or board holder, heat up your soldering iron and make sure you're ready to go!

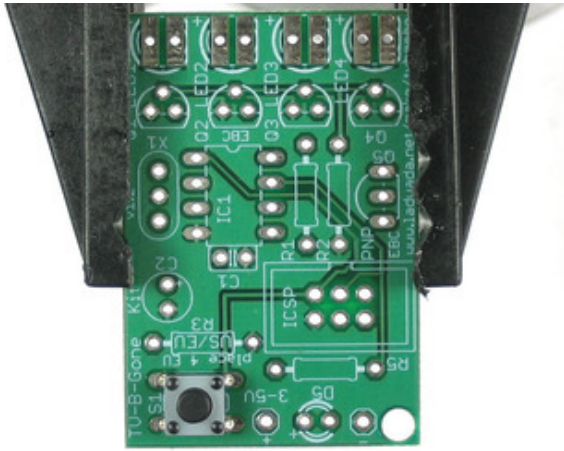

The first part we're going to assemble is the button. The button is a symmetric part so it can go in two ways. Line up the metal legs with the holes in the circuit board and snap it in. The button should sit flat against the circuit board.

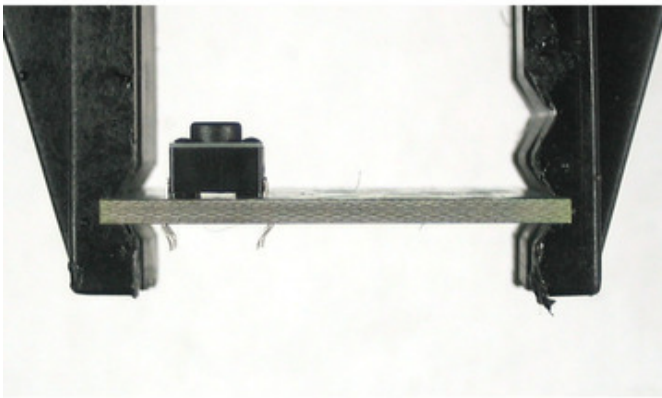



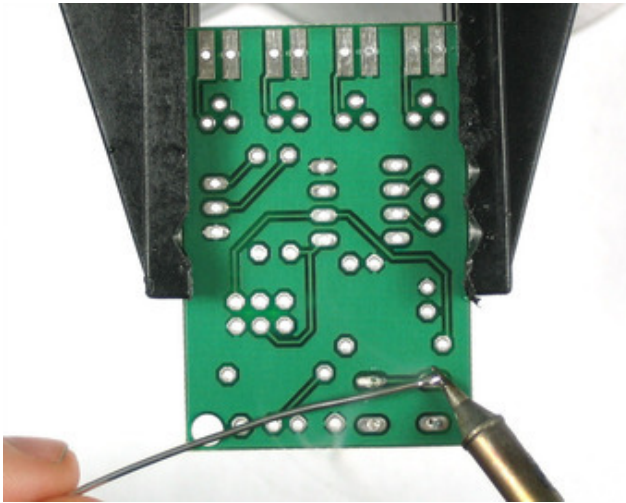

Using your soldering iron, heat up a leg of the button and the poke solder into it to make a nice solder joint.

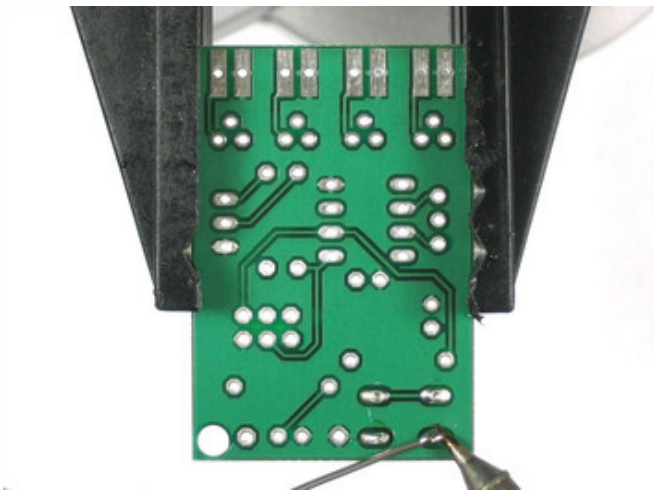

Repeat for all four legs. The solder points should be clean and shiny. [See the tutorials for soldering help if you can't get it right \(https://adafruit.it/aTk\)](https://adafruit.it/aTk).

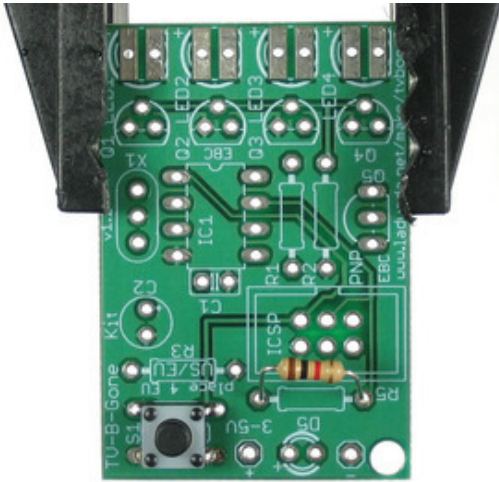

Next is the 1.0 kilo ohm resistor **R5**. This is the brown-black-red striped part. This resistor sets the brightness of the little indicator LED. Resistors are symmetric, so it can go in either way.

Bend the legs so it looks like a staple and insert it into the **R5** location as shown.

Then bend the legs out a bit so that when you turn the PCB over the part doesn't fall out.

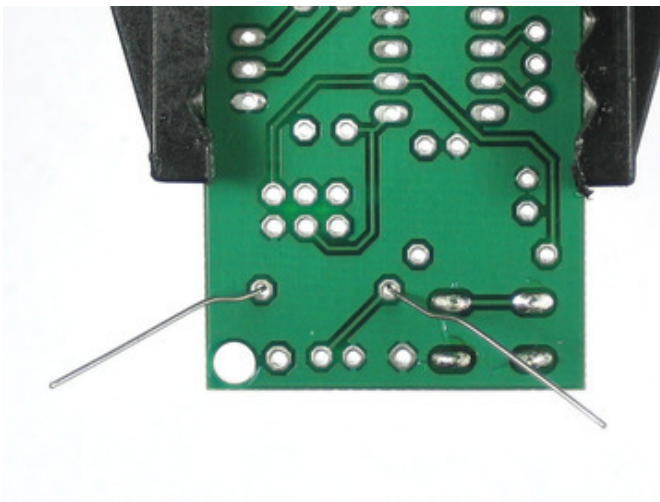
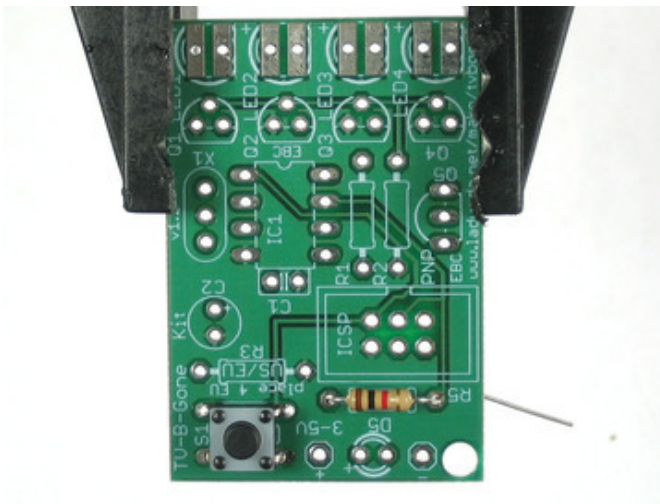

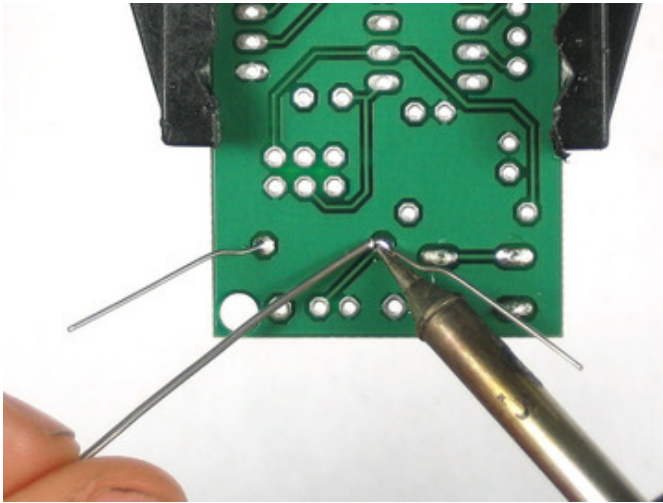

Solder each leg of the resistor.

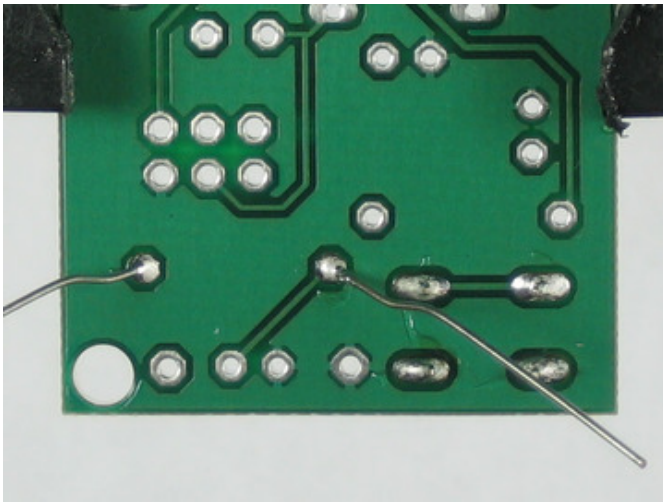

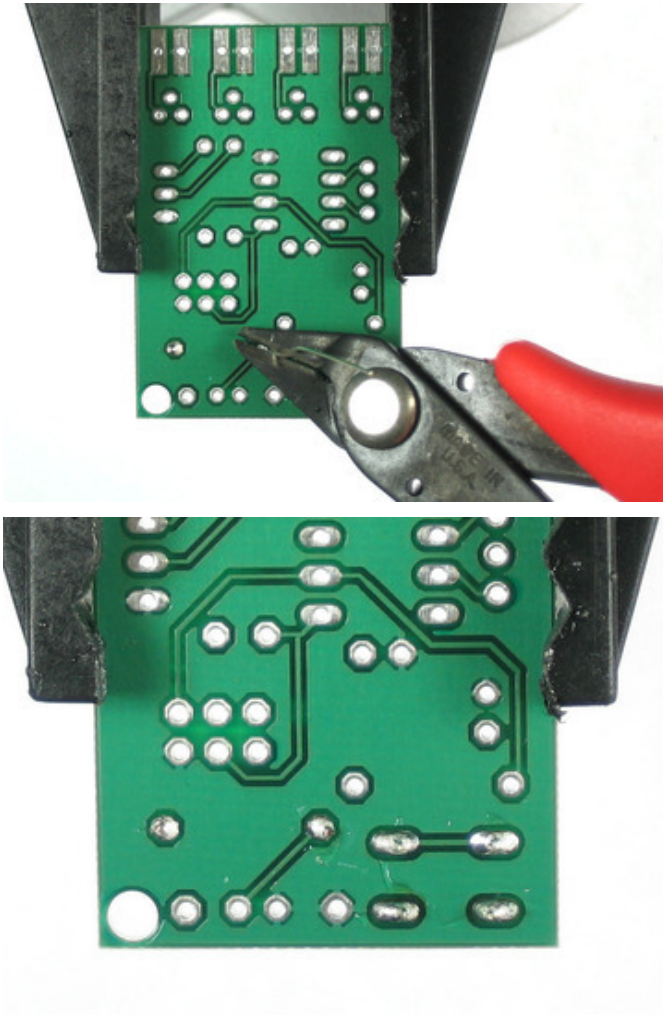

Use the diagonal cutters to clip off the resistor legs so that only the solder points remain.

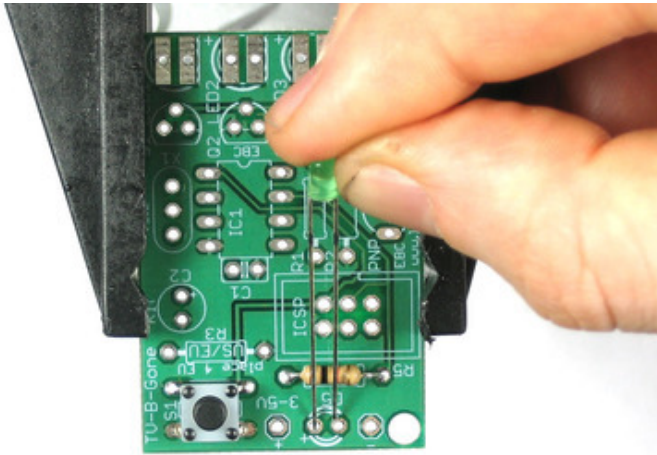

Now it's time to place the small indicator LED **LED5**. LED's are not symmetric and must be placed correctly in order to work. You'll notice one leg of the LED is longer than the other. This is the *positive* leg. The positive leg goes into the hole with a + next to it. In the picture shown, its the left hole.

Insert the LED into the correct location, and bend the leads out to keep it from falling out when you turn the PCB over.

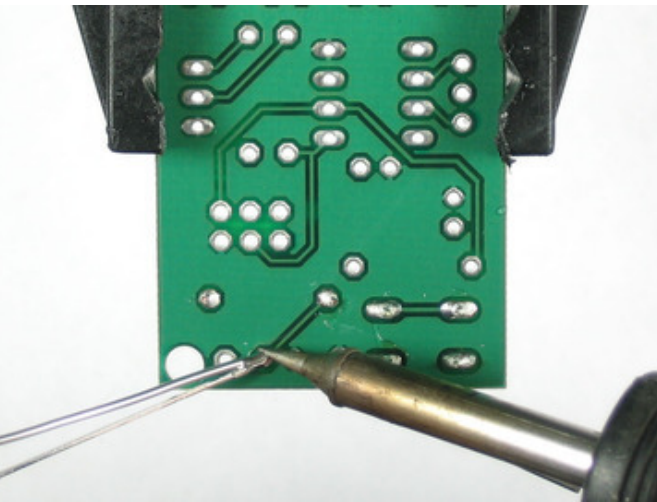
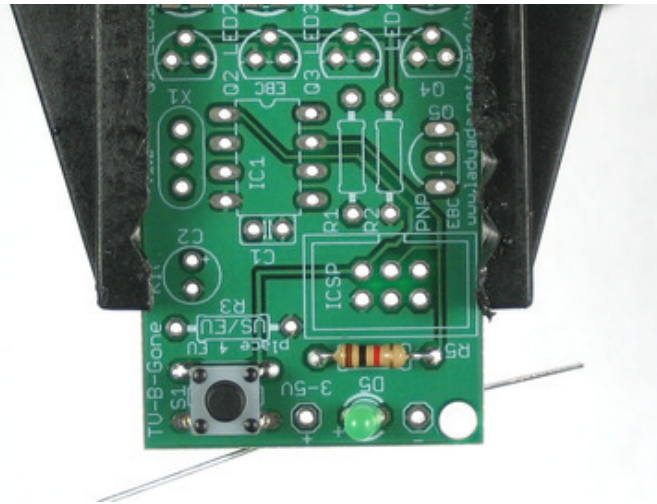

Turn the PCB over and solder both leads of the LED.

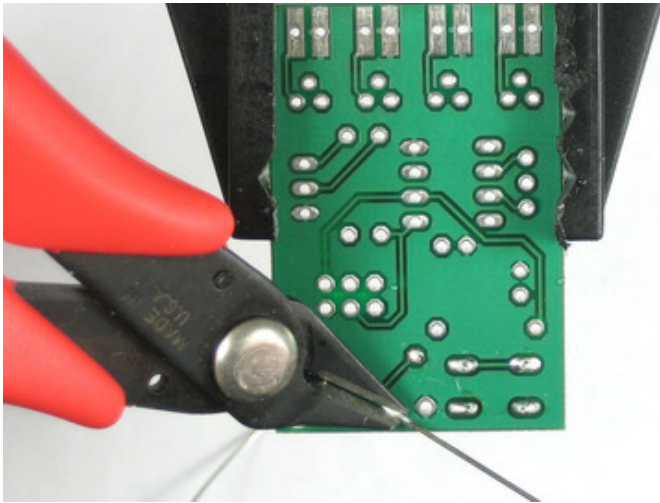

Clip both leads of the LED.

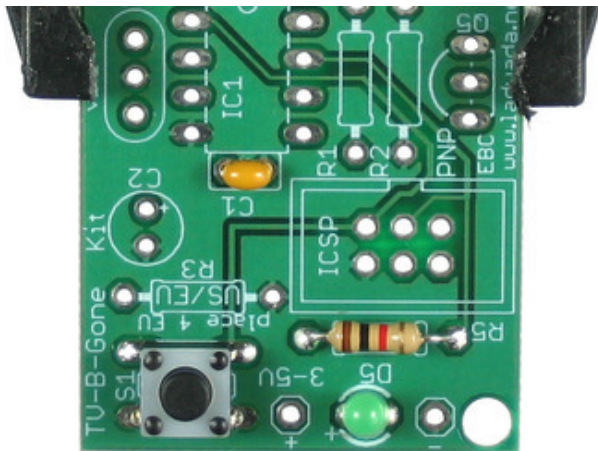

The next part is the ceramic capacitor **C1**. Ceramic capacitors are symmetric so it can go in either way.

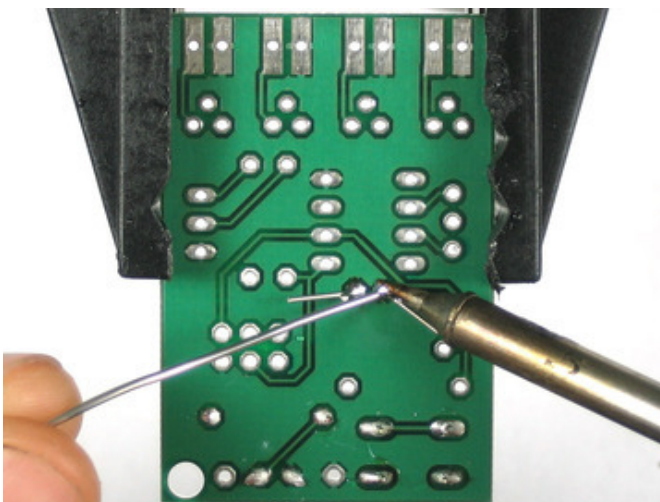

Solder and clip the ceramic capacitor part.

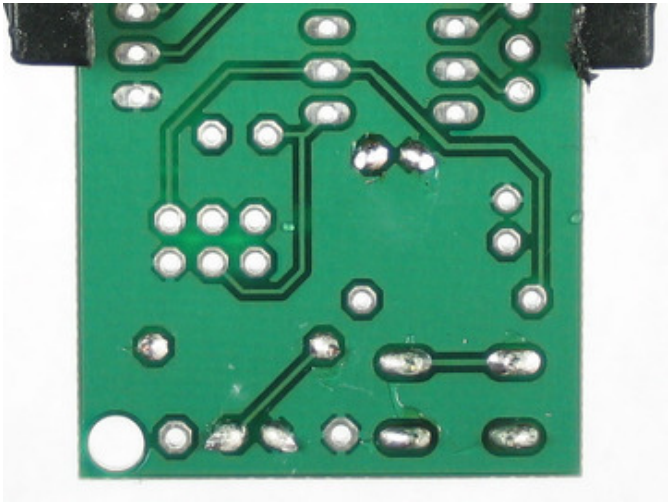
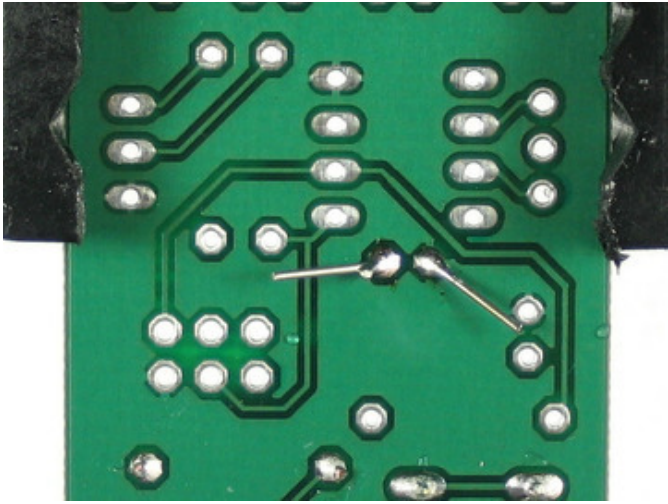

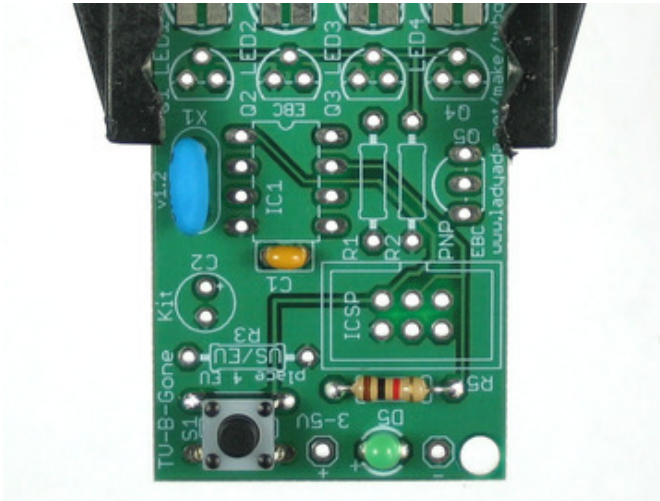

Next, place 2 components. The ceramic oscillator and the 8-pin socket. The oscillator has 3 pins and is symmetric. The oscillator is the timeclock for the microcontroller, making sure that it is performing its functions at the correct speed.

The socket is for protecting the chip and making it easy to insert and remove.

The socket has a little notch in one end. That notch should match the one in the picture silkscreened onto the circuit board. This will help you place the microcontroller in properly later.

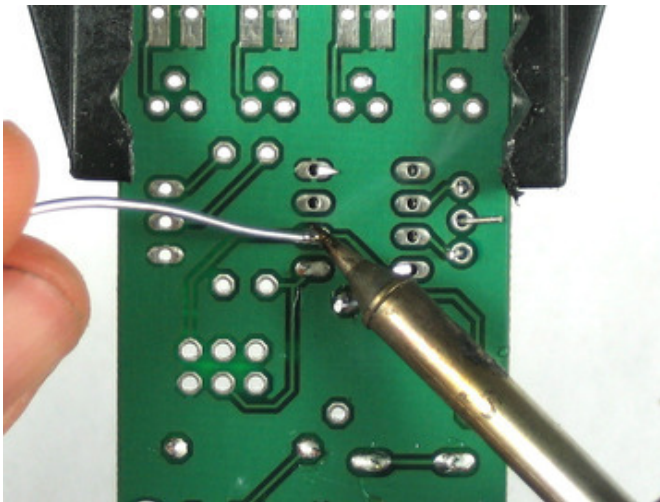
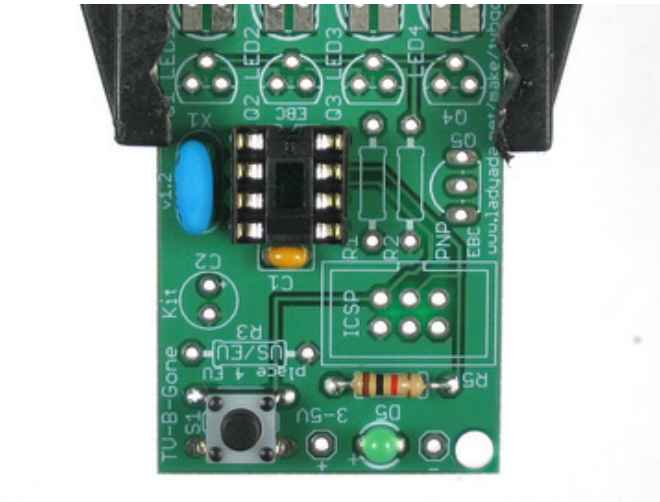

You may need to solder one pin of the socket while holding it in with a finger (or tape) as the legs aren't long enough to be bent while in place.



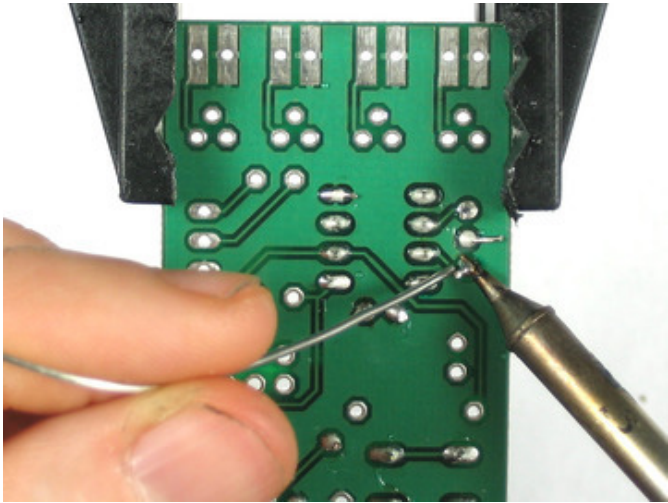

Solder the rest of the points then clip short the legs of the oscillator.

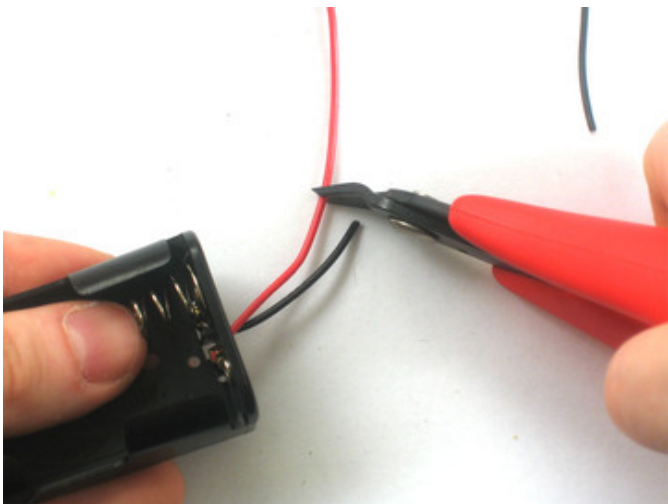
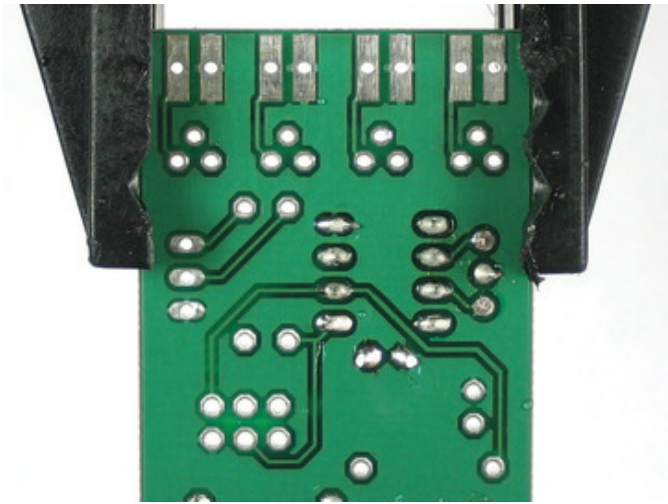

Next grab the battery holder and clip the leads short, to maybe 1.5" (4cm) long.

---

Strip the ends of the wire off so that there's a short section without insulation.



---

Use your soldering iron to 'tin' the wire, melting solder into it to keep the wire from fraying.

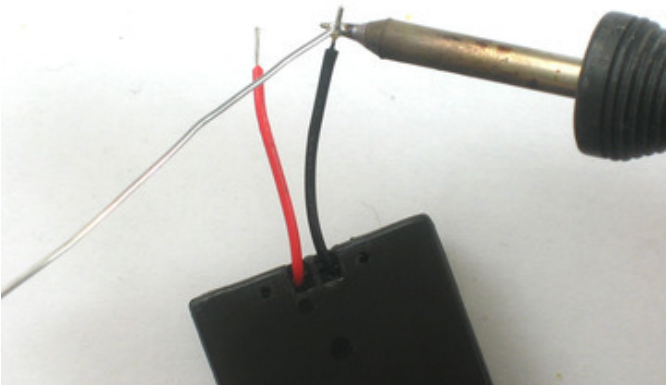

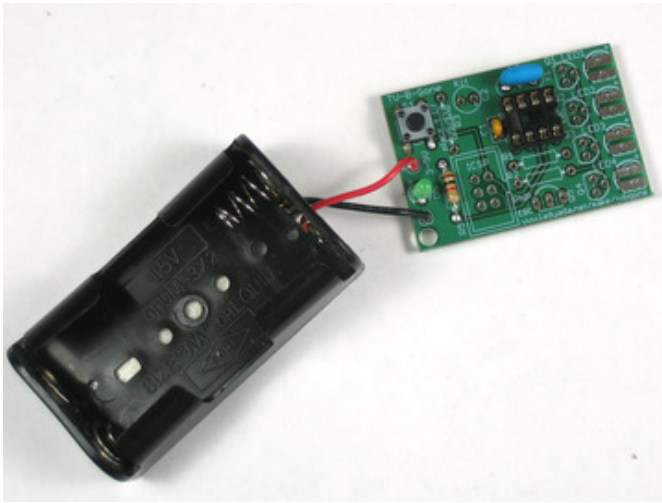

Insert the wires into the PCB so that the red wire goes to the + hole and the black wire goes to the - hole. Solder the wires, then clip them if they're too long.

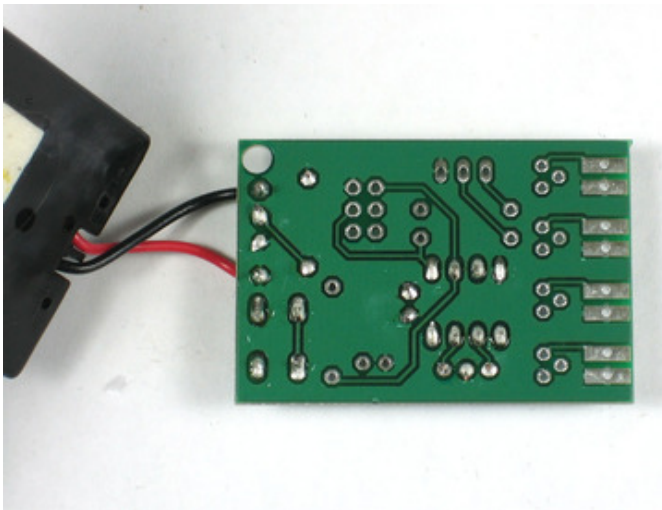
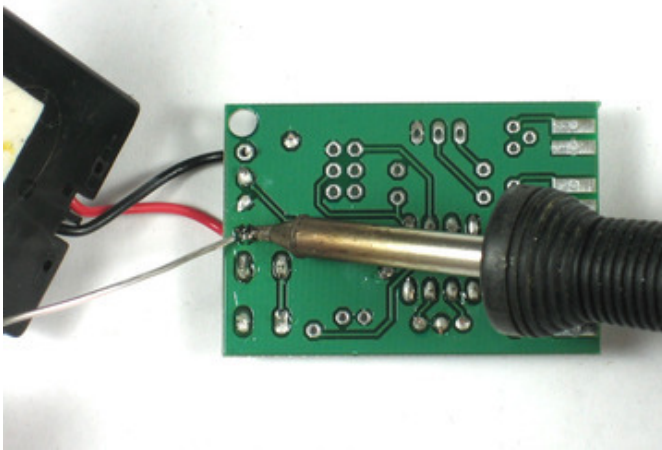

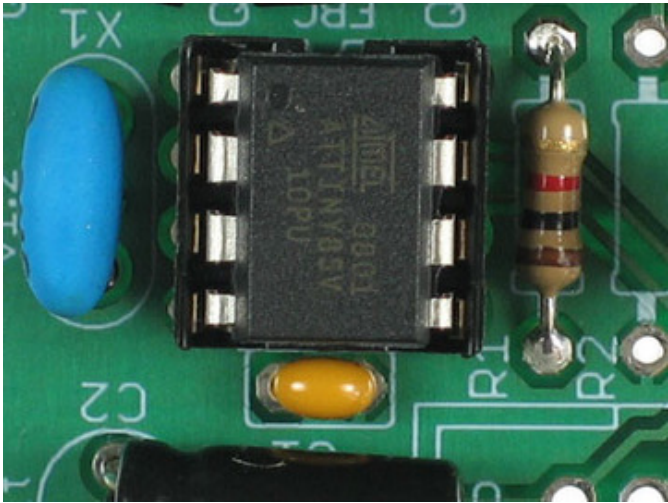

Carefully insert the microcontroller into the socket. Make sure that the little dot (and triangle) are at the end with the notch in the socket. In this photo, the dot is on the upper left.

The microcontroller is the device that stores all the codes and turns the LEDs on and off according to a program.



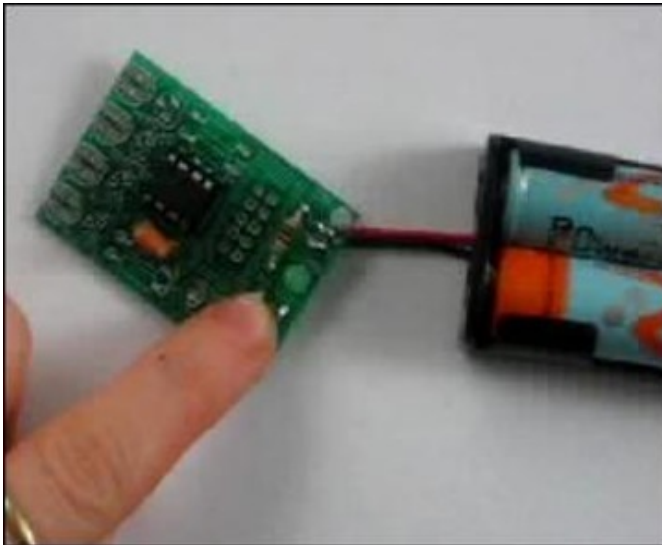

Test the kit now by putting two good AA batteries into the holder. The green indicator light should blink to show that the microcontroller is functioning properly. If you don't get a blinking light check the batteries, make sure the indicator LED is in correctly, and that the chip is in the right way.

In older kits you would have to press the button to get the blinking to start.

Once you've verified it's working, remove the batteries.

**THIS VIDEO IS EMBEDDED WITH THE PICTURE:**

<http://blip.tv/file/get/Ladyada-tvBGoneKitTest1692.flv> (<https://adafru.it/c5u>)



Next place the 1.0K ohm resistors, **R1**. This is the base resistor for the PNP transistor.

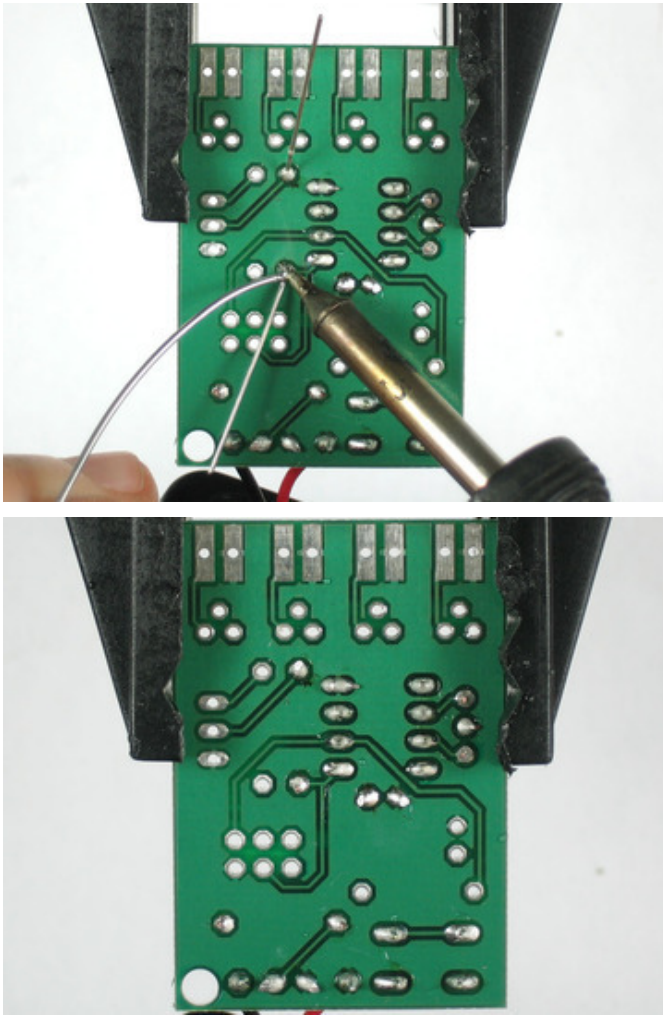

Solder and clip the resistor.

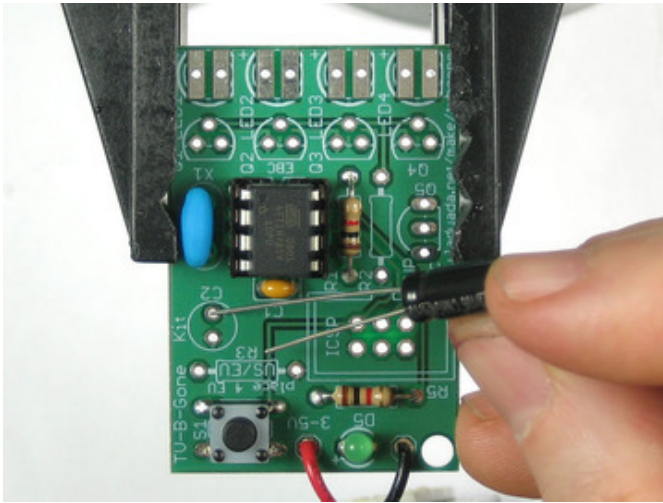

Next is the 220uF electrolytic capacitor. It is polarized so make sure it goes in the right way. The long lead is positive, and goes into the hole marked with a +, on the right in this photo.

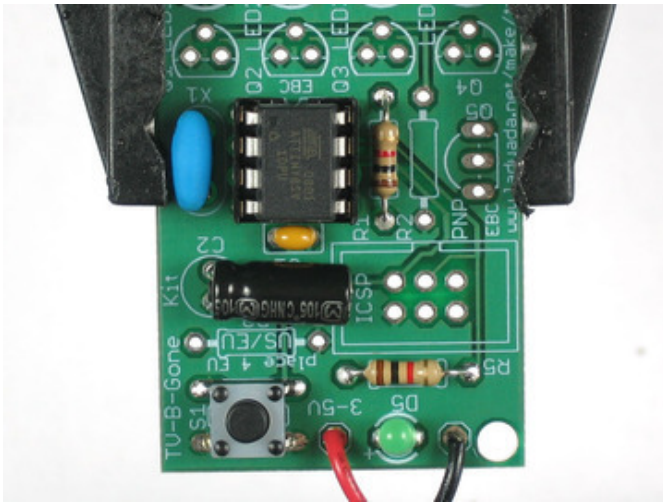

Bend the capacitor so it lies down this will make it stick out less.

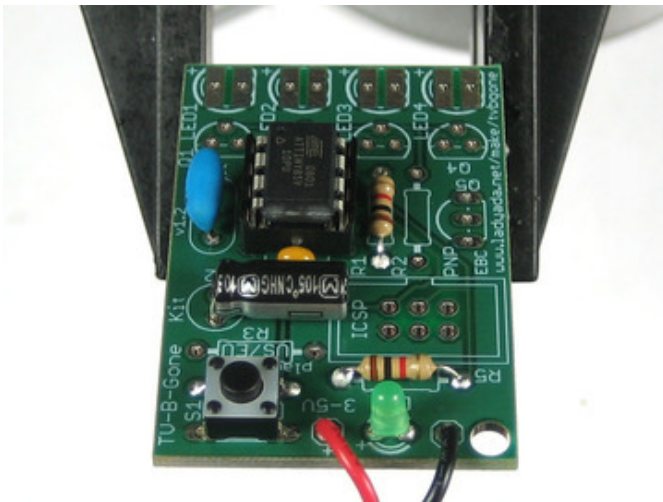

Now place the single 2N2907 PNP transistor **Q5**.

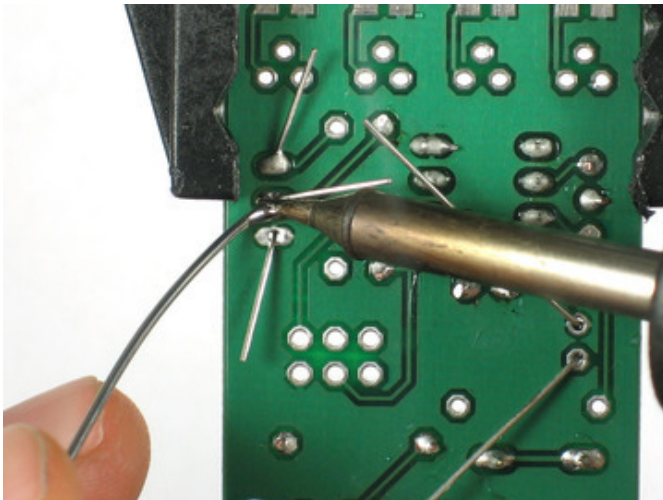
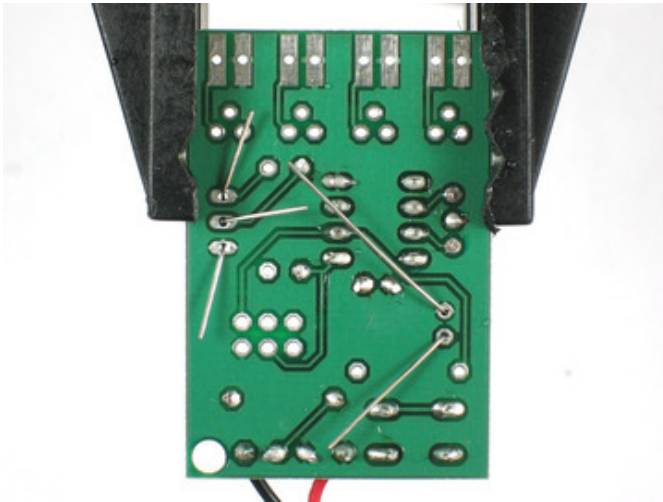
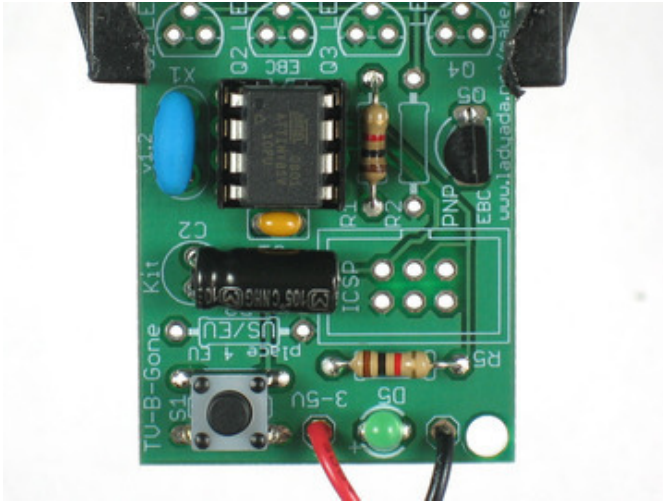



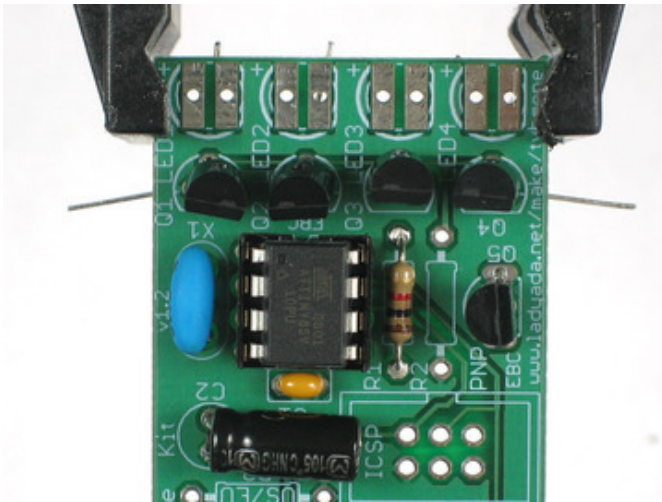
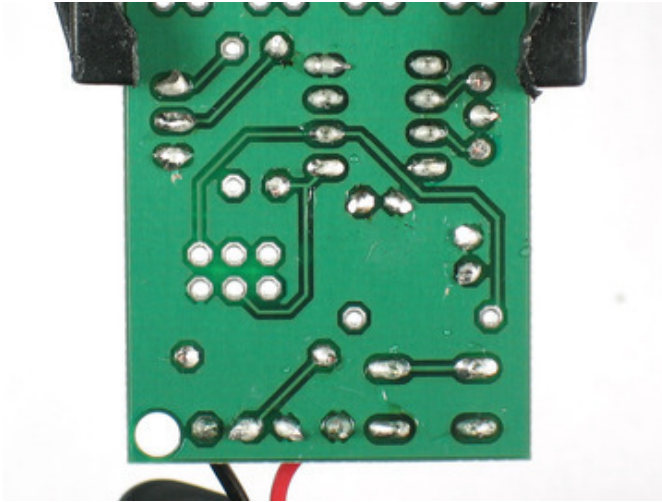

Next are the four NPN (2N2222) transistors **Q1 Q2 Q3** and **Q4**. These are the devices that turn on and off the high power IR LEDs. The microcontroller doesn't have the capability to provide a lot of power directly to the LEDs so these transistors assist it.

Transistors have three pins. Bend the middle pin back a little and insert it so that the rounded and flattened sides match up with the picture silkscreened onto the circuit board, as shown. The transistor won't be able to sit flat against the circuit board, so just make it poke up a few millimeters.

Insert all 4 transistors.

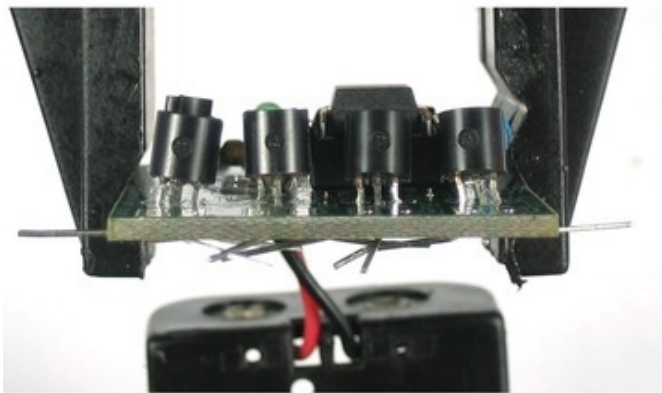

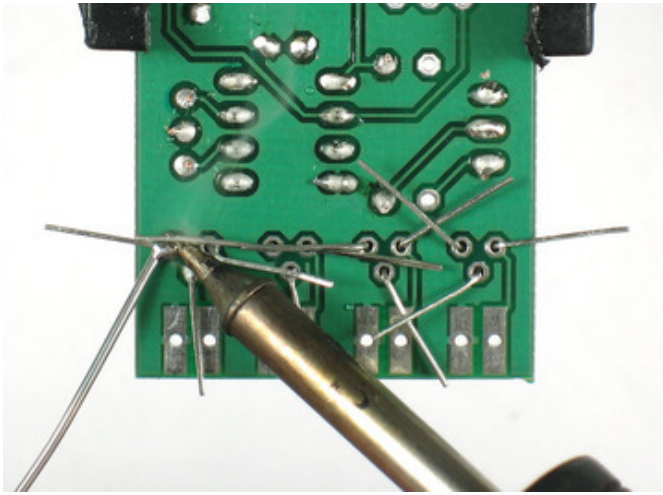

Turn the PCB over and solder in all the transistors. Then clip the wires.

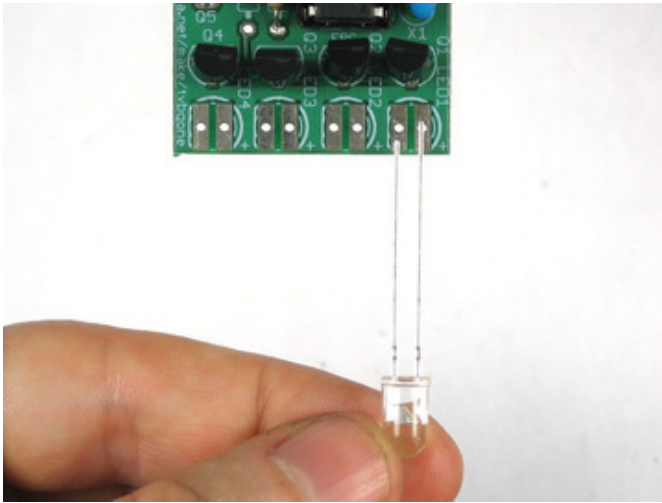

Next is the IR LEDs. Start with **LED1**, a clear IR led. Like the small indicator LED, it has polarity. Make sure the longer, positive lead is on the right, as shown.

Bend the LED over 90 degrees so it sticks out over the edge of the circuit board, see below

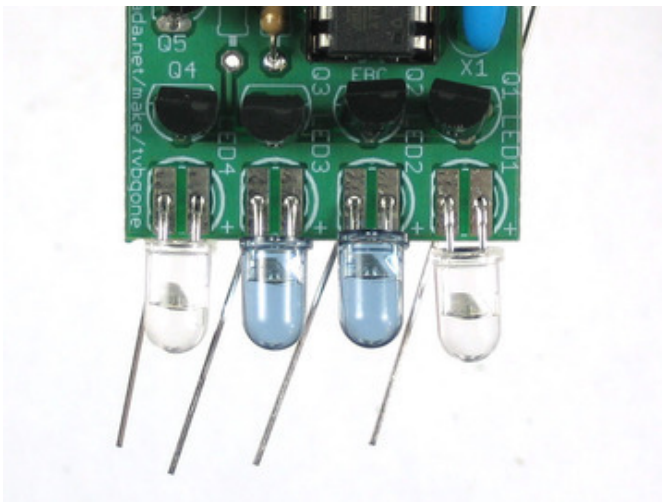
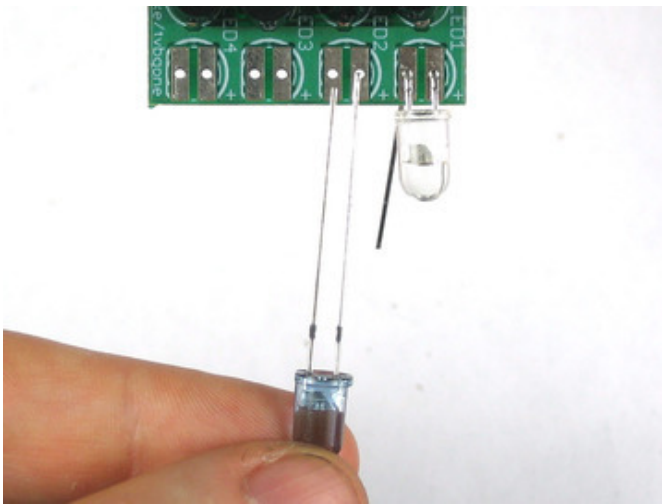

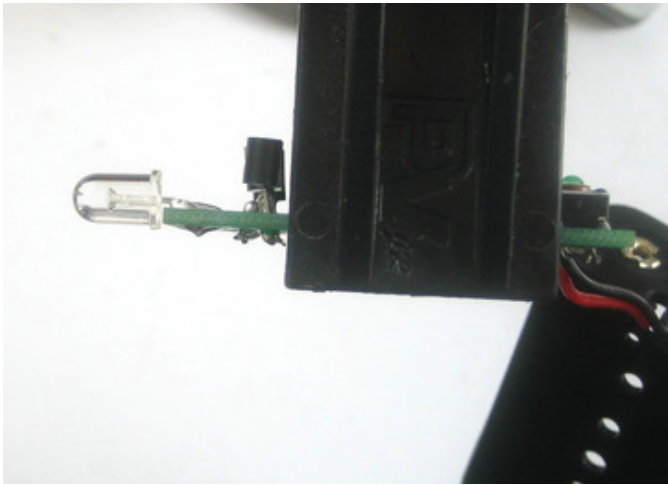

Bend the LED over 90 degrees so it sticks out over the edge of the circuit board.

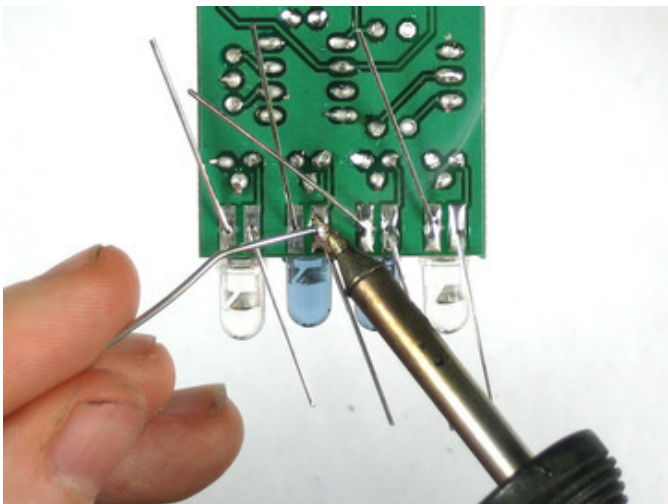

Flip over the PCB and solder it to the bottom.

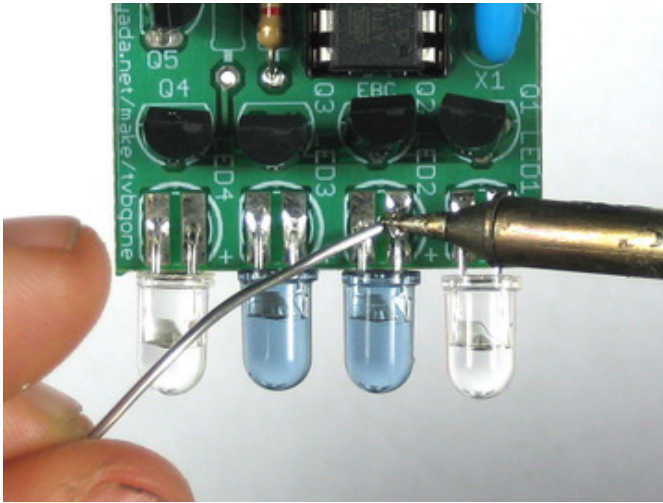

Now solder it to the top of the circuit board.

Then clip the leads.

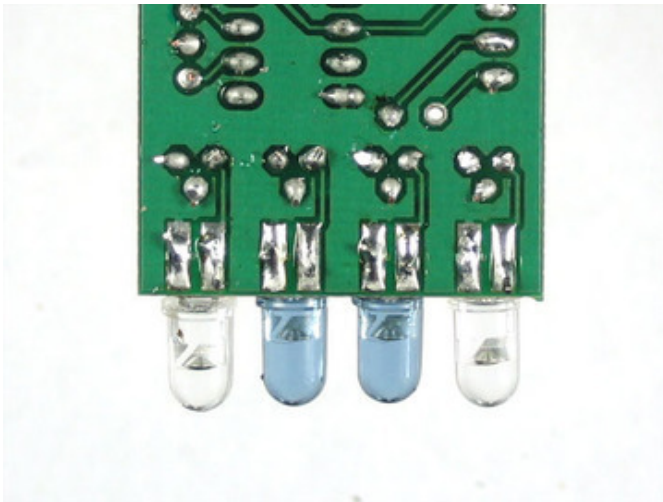
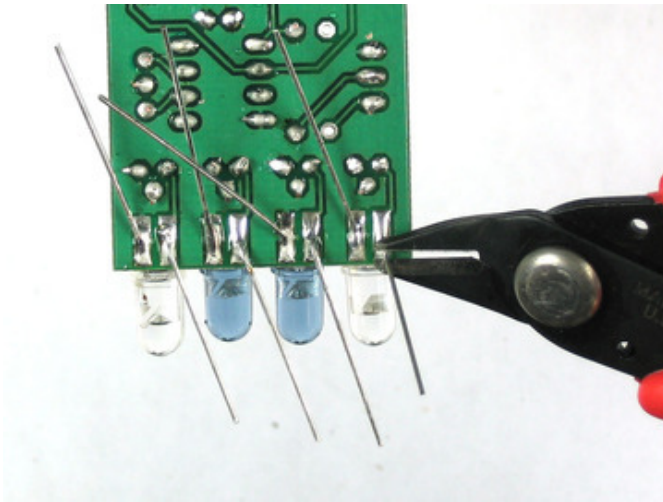

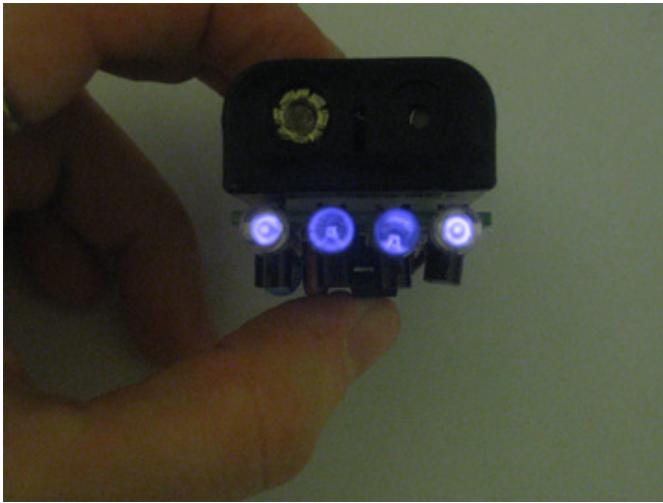

You're done soldering! Now you may want to [perform some tests to make sure it's working](#). Visit the [Testing page for more info](#). (<https://adafru.it/c5p>)

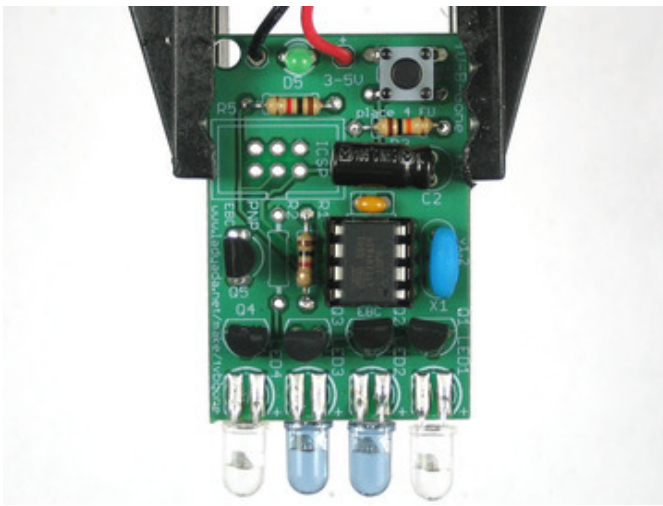

If you're in the EU, UK, Australia, place the remaining 10K resistor into **R3**. This will tell the microcontroller to use the EU database.

If you're in Asia or North America do not place R3.

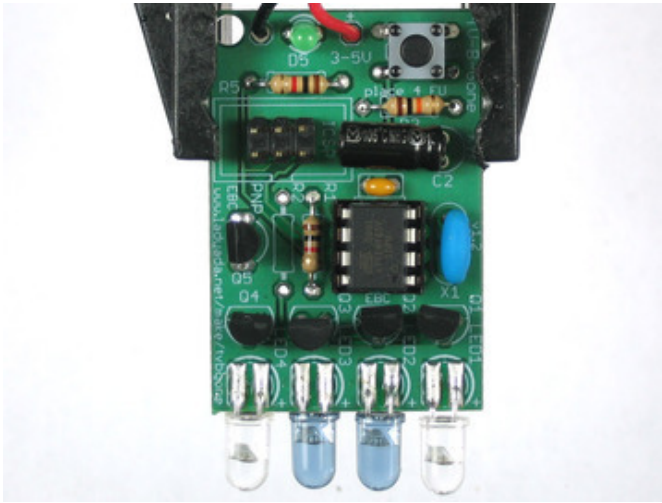

If you're planning to reprogram the chip, solder in the 6-pin ICSP header. The long pins go up.

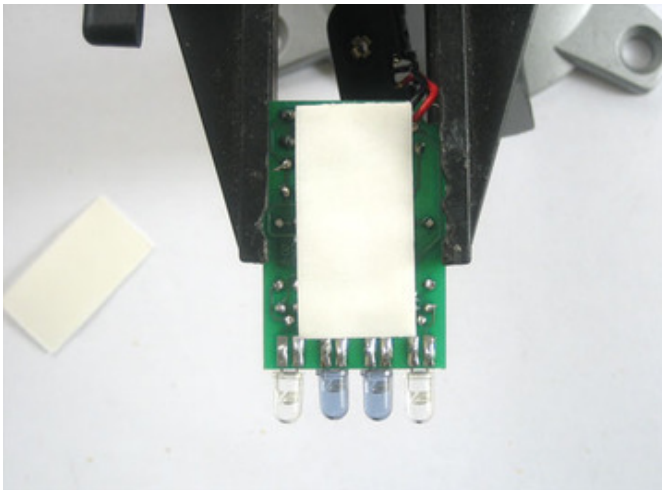

Place the doublesided foam sticky on the circuit board. Remove the other side and press the battery holder on.



Congrats, you're done!



## Test it!

---

### Test 1

With batteries in, make sure that the green LED blinks after you press the power button.

### Test 2

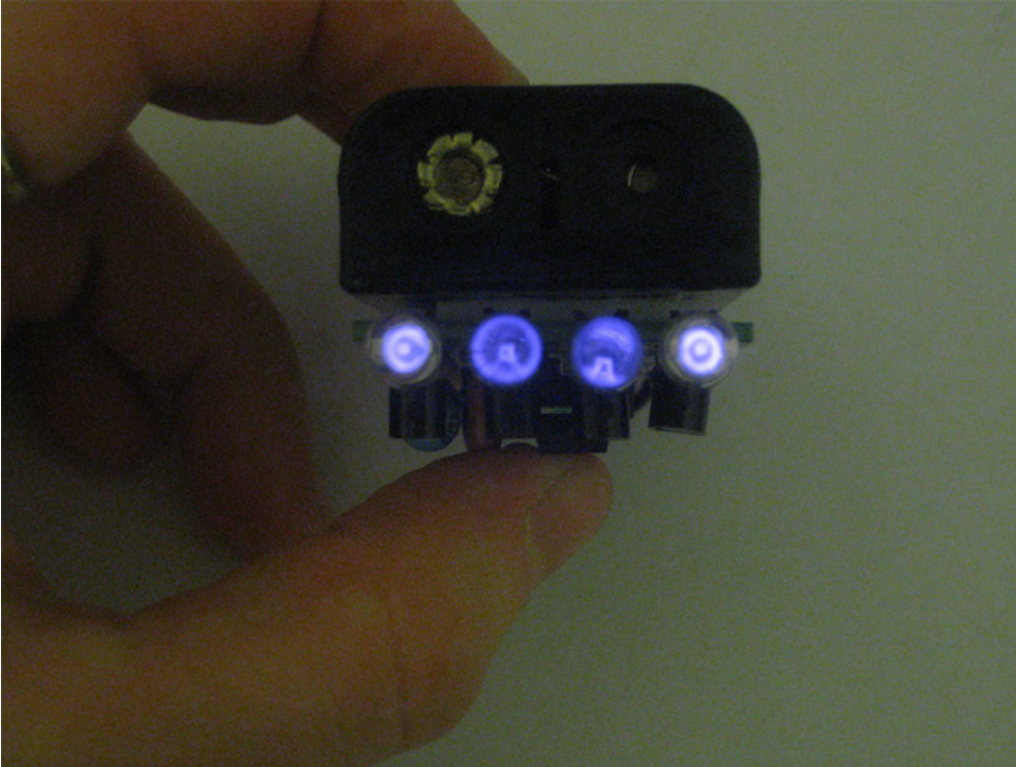

Digital cameras can detect infra-red light but our eyes can't. Use a digital camera, webcam or camcorder and look through the digital viewfinder at the IR LEDs, after pressing the button, the LEDs should flash.

Some modern Apple cameras have IR filters, so you may not see the purple light! Try another camera or skip this step!

## Use it!

---

### Very easy!

1. Simply point the device as best you can so that the Infrared LEDs are aimed at the television you'd like to turn off.
2. Press the button once. Don't hold the button down! It will just keep resetting itself. The codes start to transmit once you release the button.
3. The indicator LED will blink for every code it sends. Keep the TV-B-Gone pointed at your target until it turns off. The 4 infrared LEDs will not blink visibly because human eyes can't see infrared light.
4. When the TV-B-Gone is finished, the indicator light will blink quickly a few times and then stop.

If you press and release the button while it's sending out codes, it will reset and start over from the beginning.

The most popular codes are at the beginning, less common codes are at the end of the list.

### Video of recommended usage

## Design Notes

---

### Design Notes

Here are some notes on how the TV-B-Gone kit is designed!

Be sure to read the accompanying firmware for details on how the PWM and timers are initialized!

### Power supply

The kit is powered by 2 AA batteries. It's important that the power supply voltage be between 2.5V and 5V. Higher than that can damage the kit. Lower is too low for it to work. It's also important that the power supply be able to supply 400-1000mA easily. For AA's this is not a problem. AAA's may have issues. C or D cells are fine as are many Lithium Ion/Polymer batteries. Check your batteries if you're not using standard Alkaline AA's.

Better batteries will get you more range. "Lithium" 1.5V are excellent, Alkalines are good, and then rechargables are OK but not fantastic. Coin cells will not work at all. 9V batteries will kill the device. [See this tutorial on batteries for ideas.](#)

Using 3 batteries will also greatly improve range. 4 gets a little dangerous because 4 Alkalines is 6V which is above the suggested voltage for the chip and may damage it. 4 NiMH cells is a safe voltage for the chip, but tends to burn out the LEDs.

**Stick to 2 or 3 batteries!**

### IR LEDs

The 4 blaster LEDs are IR LEDs. They are 940nm wavelength emitters which is the most common IR used for remotes. The blue ones are narrow output (longer range but narrower), the clear ones are wide output (shorter range but wider throw). Together they should let you to hit most TVs!

### Button

There is one button. Pressing & releasing will start the kit to emit IR codes. The button is actually hooked up to the microcontroller's reset pin and tells the chip to reset. When the chip resets it automatically emits all the codes in its library. When it's done it goes into a very-low-power sleep mode and awaits another button press.

### Crystal

The 8.0 MHz resonator isn't technically a crystal but it acts the same. It generates the 8.0MHz timing clock to keep the chip on time and generating precise waveforms. There is an internal 8mhz resonator on the chip but it's not nearly precise enough and varies with battery voltage and temperature. Using an external resonator prevents that. The resonator **MUST** be 8.0MHz as the code is specifically written for that value. If you decide to change the crystal speed (there's no reason to but people ask) you will have to change the code for the new value by updating the Makefile and completely recompiling.

### IR-Driver Transistors

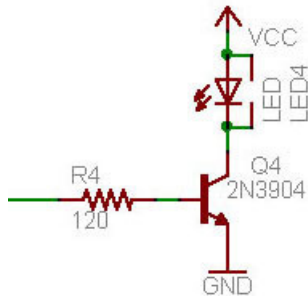

The IR LEDs have more than 100mA going through them. This is way more than a microcontroller pin can supply (usually 20 to 40 mA max!) so we use a 'driving' transistor. These NPN transistors amplify the power of a microcontroller pin and are designed to turn off currents of over 100mA. When the base pin is pulled high (through the base resistor) the transistor turns on and the LED turns on too. When the base pin is pulled to ground, the transistor turns off and no current passes through the LED.

In v1.0 kits 1 pin on the microcontroller controls four transistors each.

In v1.1 kits two pins on the microcontroller each control two transistors each (4 total) - this increased the base current to give better range.

(Please note that at the DC currents we are pushing through the transistor and the LED, the beta of the transistor is not 200 but closer to maybe 20-50,  $V_{be}$  is about a volt, and  $V_{ce\_sat}$  grows to a volt or so. Of course it depends on the transistor but just be aware that 'simple' transistor modeling is not valid anymore.)

## IR-Driver-Transistors-Driver Transistor

In v1.2 we decided that we really wanted an extra pin to do region detection. We could go back to having one micro pin control all four transistors but the range would suffer so instead we have a PNP transistor that will buffer the weak microcontroller pin and push plenty of current into the bases of the IR driver transistors.

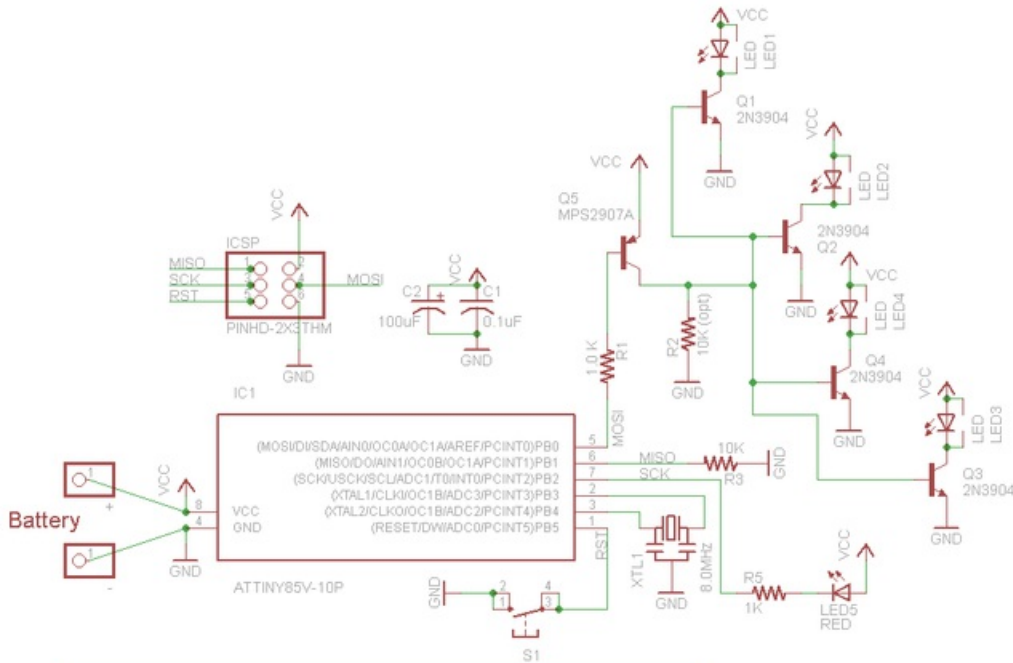

TV-B-Gone Kit		CC 2.5 BY/SA	
<a href="http://www.ladyada.net/make/tvbgone">http://www.ladyada.net/make/tvbgone</a>			
TITLE: tvbgone3			
Document Number:		REV: v1.0	
Date: 12/20/2010 9:10:50 PM		Sheet: 1/1	

Now we use one pin, PB0 to drive Q5 the PNP which connects the bases of the driver NPNs with a path to VCC.

(Note we do not use base resistors because the power supply droop, the NPN's Vce\_sat and the IR LED voltage drop will max out and limit the base current and then the Vce of the PNP will sit at the 'right' voltage.)

R2 was placed in case we needed 'help' with getting charge off of the base. Its not needed so ignore it.

### Example of a single IR code

For this example we will use the Sony power on/off IR code. It's the first code in the North American database and the 4th in the EU database. It's very simple and commonly documented!

Let's pretend we have a Sony remote, we want to extract the code from it. We'll hookup a IR sensor (like a basic photocell!) and listen in, what we see is the following:

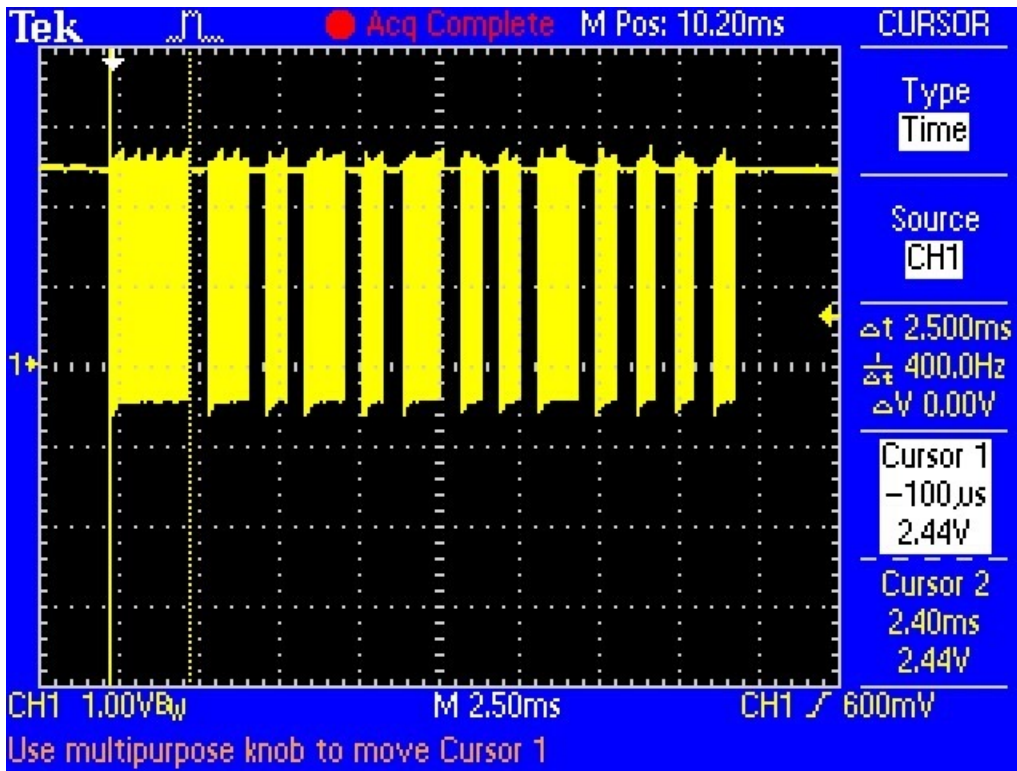

Basically we see pulses or IR signal. the yellow 'blocks' are when the IR LED is transmitting and when there is only a line, the IR LED is off. (Note that the voltage being at 3VDC is just because of the way I hooked up the sensor, if I had swapped the pullup for a pulldown it would be at ground.)

The first 'block' is about 2.5ms long (see the cursors and the measurement on the side)

If you zoom into one of those blocks...

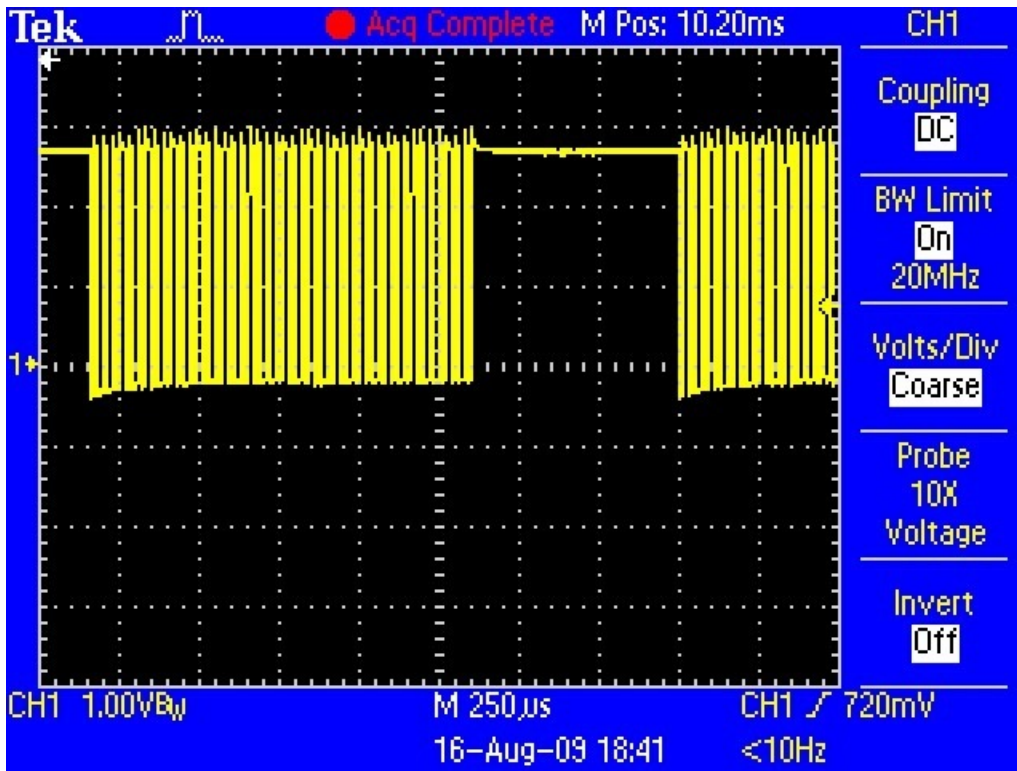

You see that they're not really 'blocks' but actually very fast pulses!

If you zoom in all the way...

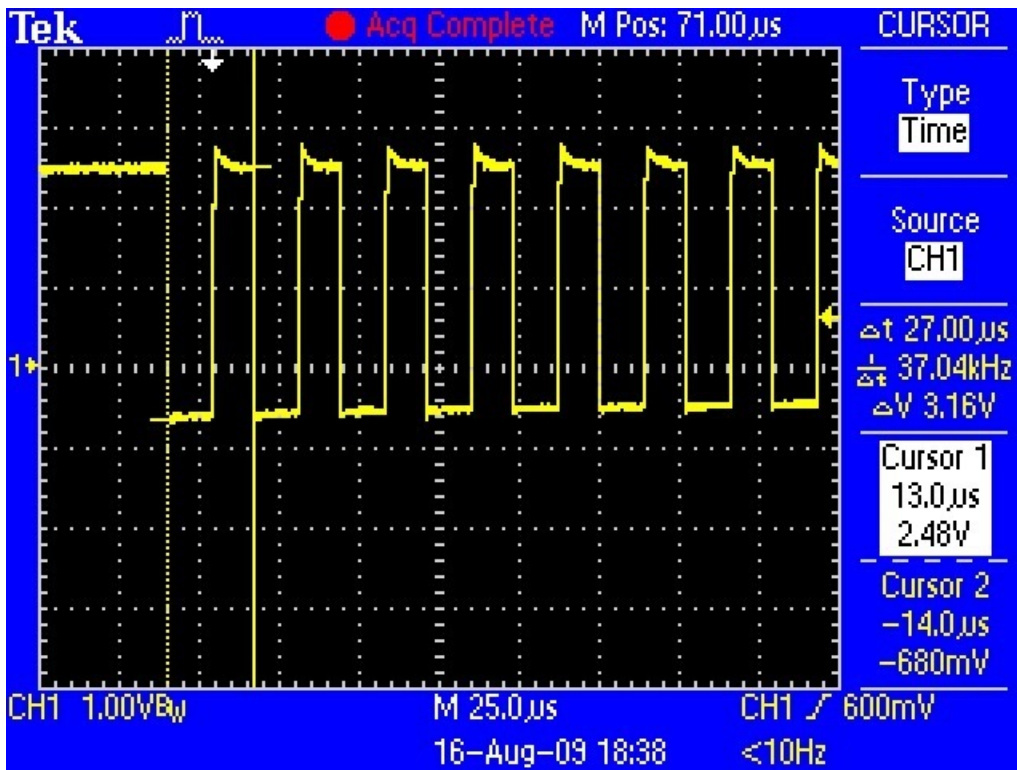

You can measure the frequency of the IR pulses. As you can tell by the cursors and the measurements on the side, the frequency is about 37.04KHz

OK so now we can understand how IR codes are sent. The IR transmitter LED is quickly pulsed (PWM - pulse width modulated) at a high frequency of 38KHz and then that PWM is likewise pulsed on and off much slower, at times that are about 1-3 ms long.

Why not have the LED just on and off? Why have PWM 'carrier' pulsing? Many reasons!

One reason is that this lets the LED cool off. IR LEDs can take up to 1 Amp (1000 milliamps!) of current. Most LEDs only take 20mA or so. This means IR LEDs are designed for high-power blasting BUT they can only take it for a few microseconds. By PWM'ing it, you let the LED cool off half the time.

Another reason is that the TV will only listen to certain frequencies of PWM. So a Sony remote at 37KHz won't be able to work with a JVC DVD player that only wants say 50KHz.

Finally, the most important reason is that by pulsing a carrier wave, you reduce the affects of ambient lighting. The TV only looks for changes in light levels that clock in around 37KHz. Just like it's easier for us to tell differences between audio tones than to pin down the precise pitch of a tone (well, for most people at least)

OK so now we know the carrier frequency. Its 37KHz. Next lets find the pulse widths!

Looking back at the first scope picture:

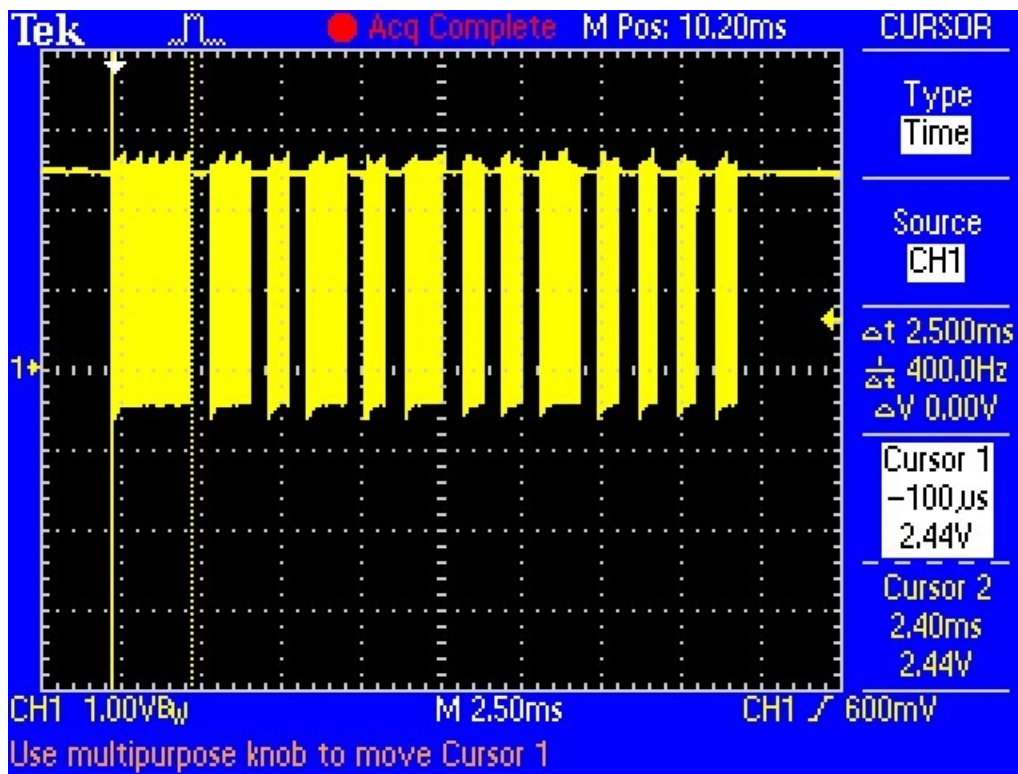

The first pulse is 2.5ms. We can use the cursors to measure the remaining pulses. I'll spare you the 12 images and let you know that the pulses are:



PWM ON	OFF
2.4 ms	0.6 ms
1.2 ms	0.6 ms
0.6 ms	0.6 ms
1.2 ms	0.6 ms
0.6 ms	0.6 ms
1.2 ms	0.6 ms
0.6 ms	0.6 ms
0.6 ms	0.6 ms
1.2 ms	0.6 ms
0.6 ms	0.6 ms
0.6 ms	0.6 ms
0.6 ms	0.6 ms
0.6 ms	270 ms

In reality the code is emitted **twice**:

<b>PWM ON</b>	<b>OFF</b>
2.4 ms	0.6 ms
1.2 ms	0.6 ms
0.6 ms	0.6 ms
1.2 ms	0.6 ms
0.6 ms	0.6 ms
1.2 ms	0.6 ms
0.6 ms	0.6 ms
0.6 ms	0.6 ms
1.2 ms	0.6 ms
0.6 ms	0.6 ms
0.6 ms	0.6 ms
0.6 ms	0.6 ms
0.6 ms	270 ms
<b>2.4 ms</b>	<b>0.6 ms</b>
<b>1.2 ms</b>	<b>0.6 ms</b>
<b>0.6 ms</b>	<b>0.6 ms</b>
<b>1.2 ms</b>	<b>0.6 ms</b>
<b>0.6 ms</b>	<b>0.6 ms</b>
<b>1.2 ms</b>	<b>0.6 ms</b>
<b>0.6 ms</b>	<b>0.6 ms</b>
<b>0.6 ms</b>	<b>0.6 ms</b>
<b>0.6 ms</b>	<b>0.6 ms</b>
<b>1.2 ms</b>	<b>0.6 ms</b>
<b>0.6 ms</b>	<b>0.6 ms</b>
<b>0.6 ms</b>	<b>0.6 ms</b>
<b>1.2 ms</b>	<b>0.6 ms</b>
<b>0.6 ms</b>	<b>0.6 ms</b>
<b>0.6 ms</b>	<b>0.6 ms</b>
<b>0.6 ms</b>	<b>0.6 ms</b>
<b>0.6 ms</b>	<b>0.6 ms</b>
<b>0.6 ms</b>	-

In previous versions (v1.0 and v1.1) we didn't do any compression. Instead we made the code literally spit out each pulse:

```

// Code 000 -- Sony, Baur, Neckermann, Otto Versand, Palladium, Quelle, SEI, Sinudyne, Sonolor, Universu
const struct powercode sonyCode PROGMEM = {
  freq_to_timerval(38400), // 38.4 KHz
  {{240, 60},
   {120, 60},
   {60, 60},
   {120, 60},
   {60, 60},
   {120, 60},
   {60, 60},
   {60, 60},
   {120, 60},
   {60, 60},
   {60, 60},
   {60, 60},
   {60, 60},
   {60, 2700},
   {240, 60},
   {120, 60},
   {60, 60},
   {120, 60},
   {60, 60},
   {120, 60},
   {60, 60},
   {120, 60},
   {60, 60},
   {60, 60},
   {120, 60},
   {60, 60},
   {60, 60},
   {60, 60},
   {60, 0} // end of code
  }
};

```

You can see that the first entry is a little function that converts the 38.4 KHz (38400 since we can't use floating point here) into a 'timer value' We use the built-in 8-bit PWM module in the chip, so we can set the frequency with an 8 bit value. Note that that value is not actually the frequency but is calculated thusly:  $\text{timer\_val} = ((F\_CPU / \text{freq} - 1) / 2)$  where F\_CPU is the clock crystal. We use an 8 MHz crystal so to generate 38.4 KHz for example, we use the value 103 or 104. The precision isn't that important and it's definitely good enough for our uses.

Then comes a long list of all the codes (I cleaned it up a little to match the 'ideal' code readings).

The timer value takes up 1 byte. Each number in the code table is 16 bits long so it can hold numbers larger than 255. That means each code pair line takes up 4 bytes. So the total memory storage needed is  $1 + 26 * 4 = 105$  bytes

## Code compression in v1.2

While the above is more readable, it's very 'bulky' and hard to fit more than 40 codes. That sucks! We want MORE codes. So we will compress them. (This code is similar to the Damian Good/Caitsith compression scheme but not identical. However, we are indebted to him for the great work!) Remember that the code looked like this:

PWM ON	OFF
2.4 ms	0.6 ms
1.2 ms	0.6 ms
0.6 ms	0.6 ms
1.2 ms	0.6 ms
0.6 ms	0.6 ms
1.2 ms	0.6 ms
0.6 ms	0.6 ms
0.6 ms	0.6 ms
1.2 ms	0.6 ms
0.6 ms	0.6 ms
0.6 ms	0.6 ms
0.6 ms	0.6 ms
0.6 ms	270 ms

Since you can see that the pairs of on/off codes repeat (not coincidentally!) we can squeeze the code down by creating a table of the "unique" pairs. I've ordered them so the first column is sorted first and then by the second column:

INDEX #	PWM ON	OFF
0	0.6 ms	0.6 ms
1	0.6 ms	270 ms
2	1.2 ms	0.6 ms
3	2.4 ms	0.6 ms

Then our code would look like this:

CODE PAIR INDEX
#3
#2
#0
#2
#0
#2
#0
#0
#2
#0
#0
#0
#1

Where to decode, we look up the on/off code pair in the **Timing Table!**

We can store the timing table in memory thusly:

```
const uint16_t code_na000Times[] PROGMEM = {
    60, 60,
    60, 2700,
    120, 60,
    240, 60,
};
```

The **const** keyword indicates that these are 'constants' - not variable data.  
The **uint16\_t** keyword indicates that the data is 16-bits long. We need 16 bits because some of the lengths are longer than 255 (which is the max size one can store in 8-bit data).  
Then comes the name, this is the **code\_na000Times** timing table, which goes with code **na000** (sony)  
Next is **[]** which indicates it's an array of values.  
The **PGGMEM** tells the compiler to store it in ROM. This is important because there is only 512 bytes of RAM but 8192 bytes of ROM (flash). By default the compiler thinks we want to store stuff in RAM because we can then change it easily. ROM cannot be modified by the chip itself easily.  
Finally, we have the table. We can't use 'floating points' so instead of storing "0.6 ms" we store "60" (multiplying everything by 100) This gives us the precision we want. When it's time to actually use the numbers we just take into account that they're 100 times too large.

This code table takes 8 (entries) \* 2 (bytes each) = **16 bytes**

Now we must store the code itself, seperately. (We don't stick the two together because multiple codes use the same

timing tables so we save memory by keeping them separate.)

Let's convert the code index list into binary. Because we only have 4 different codes, we only need 2 bits to describe each code pair. If we had 5 different codes, we'd need 3 bits which can store up to 8 different values. Once we hit 9 different code pairs, we need 4 bits, etc...

Now one thing we skipped before is that the code is actually transmitted *twice* so we need to double up the table!

CODE PAIR INDEX	In Binary
#3	11
#2	10
#0	00
#2	10
#0	00
#2	10
#0	00
#0	00
#2	10
#0	00
#0	00
#0	00
#1	01
#3	11
#2	10
#0	00
#2	10
#0	00
#2	10
#0	00
#0	00
#2	10
#0	00
#0	00
#2	10
#0	00
#0	00
#1	01

Great! We have our full code now. So our code can now be turned into a chunk of data, we append each code pair index to each other to create this 'string' of bits:

```
1110001000100000100000000111100010001000001000000001
```

Which we divide into 8 bit groups:

```
11100010 00100000 10000000 01111000 10001000 00100000 0001
```

Then we 'pad' out the final chunk so it's a full 8 bits long:

```
11100010 00100000 10000000 01111000 10001000 00100000 00010000
```

In hexadecimal, we can describe the code in 7 bytes:

```
0xE2 0x20 0x80 0x78 0x88 0x20 0x10
```

That's -really- compressed. We will have to now describe the code in a way that it can be 'unpacked'

Here is how we will describe the code. First we will create a C structure so that the compiler will put things in order properly:

```
// The structure of compressed code entries
struct IrCode {
    uint8_t timer_val;
    uint8_t numpairs;
    uint8_t bitcompression;
    uint16_t const *times;
    uint8_t codes[];
};
```

The first byte **timer\_val** is the way we set the carrier frequency. We use the built-in 8-bit PWM module in the chip, so we can set the frequency with an 8 bit value. Note that that value is not actually the frequency but is calculated thusly: **timer\_val = ((F\_CPU / freq - 1) / 2)** where F\_CPU is the clock crystal. We use an 8 MHz crystal so to generate 38.4 KHz for example, we use the value 103 or 104. The precision isn't that important and it's definitely good enough for our uses.

**numpairs** lets us store how many pairs are in the code. So we know when to stop!

**bitcompression** tells the program how many bits we used to compress the code, for example in this case we used 2 bits

**times** is a pointer (address) to the timing table

**codes** is a list of the codes!

Next is the code itself:

```

const struct IrCode code_na000Code PROGMEM = {
    freq_to_timerval(38400),
    26,                // # of pairs
    2,                // # of bits per index
    code_na000Times,
    {
        0xE2,
        0x20,
        0x80,
        0x78,
        0x88,
        0x20,
        0x10,
    }
};

```

**const** and **PROGMEM** are the same as before, just tells the compiler to stick this into ROM. **struct IrCode** tells the compiler this must be in the form we indicated earlier.

Then we have the function that turns the frequency (38400 is our way of writing 38.4 KHz) into the right 8 bit number. Then the number of pairs (13 in the code, emitted twice!), the 2-bit compression method, the name of the timing table, and the compressed code.

The final storage necessary for the sony code is **16 bytes** (for the table) + **1** (for the timer val) + **1** (for the compression notice) + **2** (for the timer table pointer) + **7** (for the code itself) = **27 bytes** Compare that to the previous version that took 105 bytes!

Of course, to do this by hand is awful. Instead, we grabbed the data from a 'universal remote' and used a perl script (check the download page) to automate it. Because the timing is not very precise coming out of these universal remotes, we 'cleaned up' the Sony code but you'll notice that other codes are not nearly as tidy - the frequency may be off, the pulse widths varying, etc.



## Download

### Download files for the kit designs

#### Files for v1.2 PCB (and matching firmware)

Here are the hardware and firmware files for v1.2, distributed under Creative Commons 2.5 Attribution, Share-Alike:

- [Schematic and Layout files in Eagle format on github](#) (to download click Download in top right)
- [Schematic in PNG](#)
- [Firmware](#) for AVR-GCC

[Caitsith](#) modded the v1.2 firmware to support 'looping' if its set to US or EU only, check it out

#### Files for v1.1 PCB

Here are the hardware and firmware files for v1.1 PCB, distributed under Creative Commons 2.5 Attribution, Share-Alike:

- [Schematic](#) and [Layout](#) files in Eagle format
- [Firmware](#) for AVR-GCC
- [Newer firmware with fix for 'always on' bug \(?\)](#)

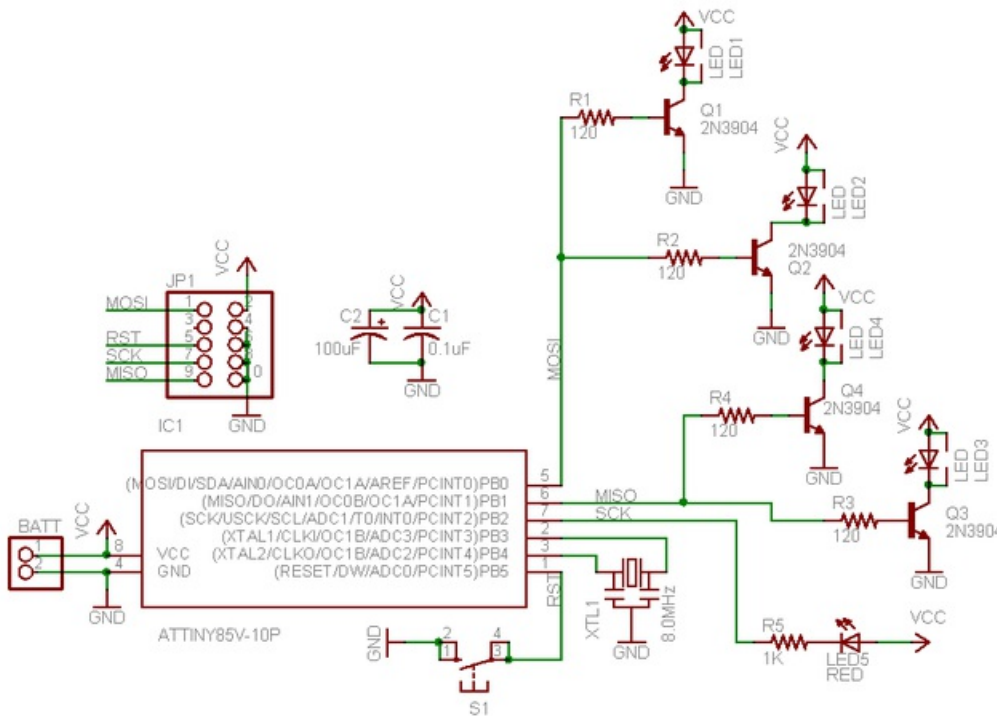

TV-B-Gone Kit		CC 2.5 BY/SA
<a href="http://www.ladyada.net/make/tvbgone">http://www.ladyada.net/make/tvbgone</a>		
TITLE: tvbgone2		
Document Number:		REV: v1.1
Date: 11/02/2007 12:25:14a		Sheet: 1/1

## Files for v1.0 PCB

Here are the hardware and firmware files for v1.0 PCB, distributed under Creative Commons 2.5 Attribution, Share-Alike:

- [Schematic](#) and [Layout](#) files in Eagle format
- [Firmware](#) for AVR-GCC

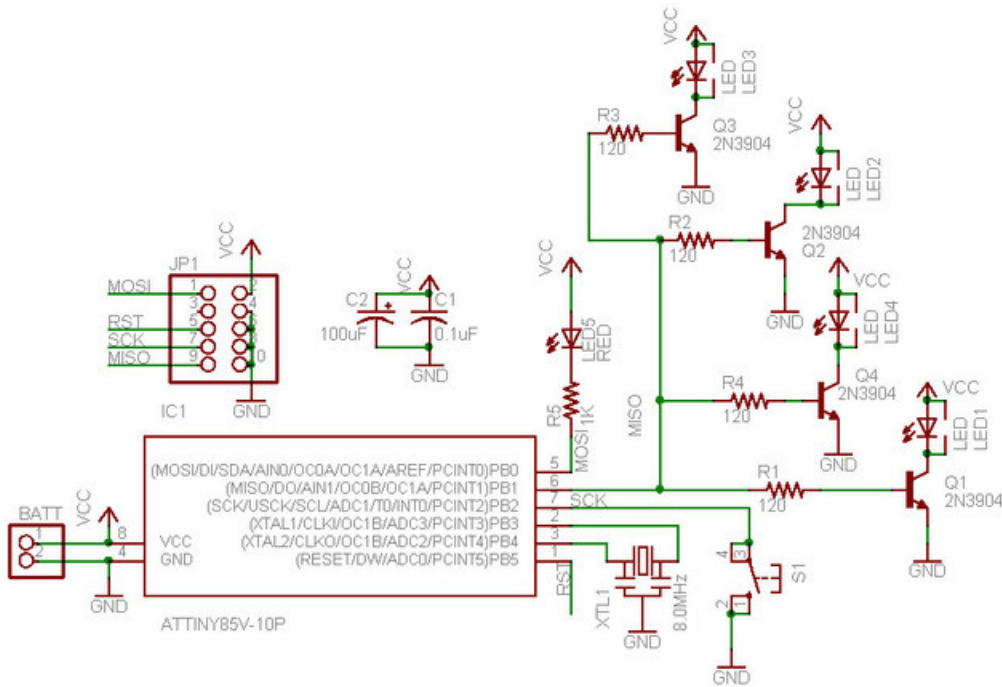

## Buy Kit

[Buy Kit \(https://adafru.it/c5J\)](https://adafru.it/c5J)

---

## Forums

[Forums \(https://adafru.it/forums\)](https://adafru.it/forums)

---