

PLEASE CHECK WWW.MOLEX.COM FOR LATEST PART INFORMATION

Part Number: [5055750771](#)
Status: **Active**
Overview: Micro-Lock Plus Wire-to-Board Connector System
Description: Micro-Lock PLUS Vertical Header, 2.00mm Pitch, Single Row, Matte Tin Plating, 7 Circuits, Black

Documents:

Drawing (PDF)	Application Specification 5055700001-A03 (PDF)
Product Specification 5055700001-001 (PDF)	Packaging Specification 5055759200-200 (PDF)
Application Specification 5055700001-A02 (PDF)	RoHS Certificate of Compliance (PDF)

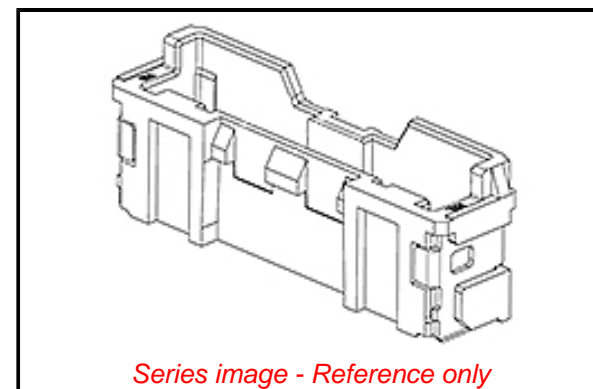

General

Product Family	PCB Headers
Series	505575
Application	Signal, Wire-to-Board
Overview	<u>Micro-Lock Plus Wire-to-Board Connector System</u>
Product Name	Micro-Lock PLUS
UPC	889056579742

Physical

Breakaway	No
Circuits (Loaded)	7
Circuits (maximum)	7
Color - Resin	Black
Durability (mating cycles max)	30
First Mate / Last Break	No
Glow-Wire Capable	No
Guide to Mating Part	No
Keying to Mating Part	None
Lock to Mating Part	Yes
Material - Metal	Brass
Material - Plating Mating	Matte Tin
Material - Plating Termination	Matte Tin
Material - Resin	Polyamide
Net Weight	817.860/mg
Number of Rows	1
Orientation	Vertical
PCB Locator	No
PCB Retention	Yes
Packaging Type	Embossed Tape on Reel
Pitch - Mating Interface	2.00mm
Pitch - Termination Interface	2.00mm
Plating min - Mating	1.000µm
Plating min - Termination	1.000µm
Polarized to Mating Part	Yes
Polarized to PCB	Yes
Stackable	No
Temperature Range - Operating	-40°C to +105°C
Termination Interface: Style	Surface Mount

Electrical

Current - Maximum per Contact	3.0A
Voltage - Maximum	250V AC (RMS)/DC

Material Info

Reference - Drawing Numbers

Application Specification	5055700001-A02, 5055700001-A03
---------------------------	--------------------------------

EU ELV

Not Relevant

EU RoHS

Compliant

REACH SVHC

Not Contained Per
-ED/01/2018 (15
January 2018)

Halogen-Free

Status

Low-Halogen

Need more information on product environmental compliance?

Email productcompliance@molex.com
Please visit the [Contact Us](#) section for any non-product compliance questions.

China ROHS	Green Image
ELV	Not Relevant
RoHS Phthalates	Not Contained

Search Parts in this Series

[505575](#) Series

Mates With

Micro-Lock PLUS Receptacle Housing
[505570](#)

Packaging Specification
Product Specification
Sales Drawing

5055759200-200
5055700001-001
5055750001-000, 5055750001-001

This document was generated on 03/27/2018

PLEASE CHECK WWW.MOLEX.COM FOR LATEST PART INFORMATION