

MAX22191

Parasitically Powered Digital Input

General Description

The MAX22191 is an IEC 61131-2 compliant, industrial digital input (DI) device that translates a 24V digital industrial input to a 2.4mA (typ) current for driving optical isolators. Voltage thresholds and current levels in the MAX22191 are compliant with Type 1 and Type 3 inputs, while minimizing power dissipation. The MAX22191 is also compliant with 48V inputs, with the addition of external resistors.

Operating power is derived from the input signal, eliminating the need for an external field-side power supply. A 250ns (max) fast response time is ideal for high-speed inputs. Additionally, a CMOS-compatible test input is available for safety diagnostics.

The MAX22191 features robust functionality for harsh industrial systems and is capable of normal operation with input signals ranging from -60V to +60V. Integrated thermal shutdown further protects the device when V_{CC} is present.

The MAX22191 is available in a small, 6-lead SOT23 package and operates over the -40°C to +125°C ambient temperature range.

Applications

- Process Automation
- Industrial Automation
- Motor Controls
- Individually Isolated Inputs
- Current Sourcing Inputs

Benefits and Features

- High Integration for Flexible Circuit Designs
 - 250ns (max) Response Time
 - Parasitically Powered from the Field Input
 - Current Sourcing Input with Optical Isolators
 - Current Sinking Input with Optical Isolators
 - Current Sinking Input with Logic Devices
 - Test Pulse Input
- Reduced Power and Heat Dissipation
 - Current Limited Input
- Robust Design
 - Operates from -60V to +60V Input Voltage
 - -40°C to +125°C Ambient Operating Temperature

Ordering Information appears at end of data sheet.

Simplified Block Diagram

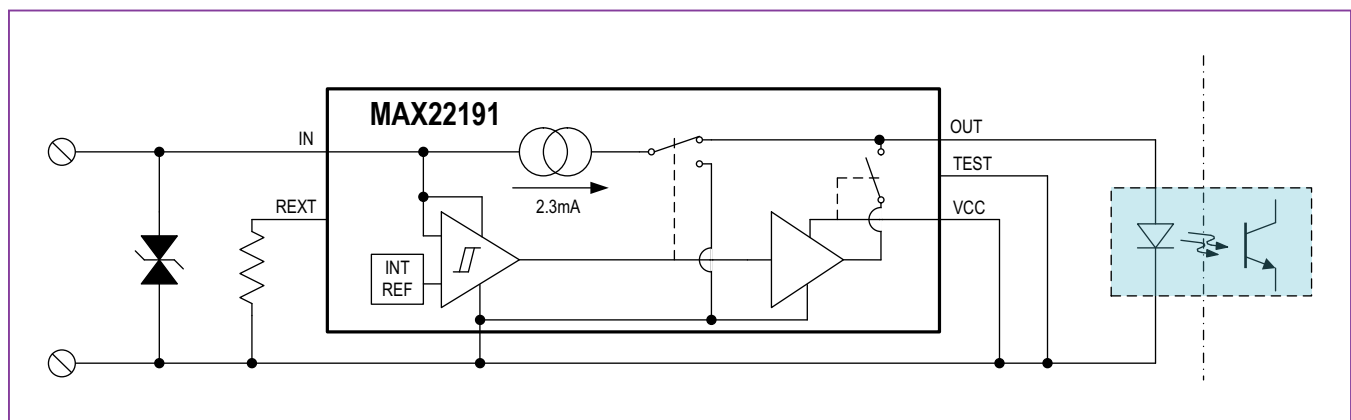

Absolute Maximum Ratings

(All voltages referenced to GND, unless otherwise stated)

V _{CC}	-0.3V to +6V
I _N	-70V to +60V
TEST	-0.3V to +6V
OUT (3.0V ≤ V _{CC} ≤ 5.5V)	-0.3V to (V _{CC} + 0.3V)
OUT (V _{CC} = 0V)	-0.3V to min [(V _{IN} + 0.3V), +6V]
R _{EXT} (3.0V ≤ V _{CC} ≤ 5.5V)	-0.3V to (V _{CC} + 0.3V)
R _{EXT} (V _{CC} = 0V)	-0.3V to min [(V _{IN} + 0.3V), +6V]
Short-Circuit Duration	
OUT to GND	Continuous

Continuous Power Dissipation (T _A = +70°C)	
6L SOT23 (derate at 8.7mW/°C above +70°C)	696mW
Operating Temperature Range	
Ambient Temperature	-40°C to +125°C
Junction Temperature	+150°C
Storage Temperature Range	-65°C to +150°C
Lead Temperature (soldering, 10s)	+300°C
Soldering (reflow)	+260°C

Stresses beyond those listed under "Absolute Maximum Ratings" may cause permanent damage to the device. These are stress ratings only, and functional operation of the device at these or any other conditions beyond those indicated in the operational sections of the specifications is not implied. Exposure to absolute maximum rating conditions for extended periods may affect device reliability.

Package Thermal Characteristics (Note 1)

6L SOT23

Junction-to-Ambient Thermal Resistance (θ _{JA})		Junction-to-Case Thermal Resistance (θ _{JC})	
Multilayer Board	115°C/W	Multilayer Board	80°C/W

Note 1: Package thermal resistances were obtained using the method described in JEDEC specification JESD51-7, using a four-layer board. For detailed information on package thermal considerations, refer to www.maximintegrated.com/thermal-tutorial.

DC Electrical Characteristics

V_{IN} = 0V to 60V, V_{CC} = 0V, T_A = -40°C to +125°C, unless otherwise noted. Typical values are at V_{IN} = 24V, R_{EXT} = 40.2kΩ (±1%), and T_A = +25°C. (Notes 2, 3)

PARAMETER	SYMBOL	CONDITIONS	MIN	TYP	MAX	UNITS
DIGITAL INPUT (I_N)						
IN Functional Operating Range	V _{IN_F}		-60		+60	V
IN Voltage Upper Threshold	V _{INTHU}	OUT is high			10	V
					10	V
IN Voltage Lower Threshold	V _{INTHL}	OUT is low	7			V
			7			V
IN Current Low	I _{INL}	V _{IN} = 7V, steady state, R _{EXT} = 40.2kΩ, V _{OUT} = 3V	1.5			mA
			1.5			mA
IN Boost Current	I _{INB}	V _{IN} < V _{INTHU} (Note 4)		4	5.5	mA
IN Current High	I _{INH}	V _{IN} = 10V to 36V, steady state, R _{EXT} = 40.2kΩ, V _{OUT} = 0V to 3V	2.1	2.4	2.7	mA
			2.1		2.75	mA
OUTPUT (O_{UT})						
OUT Load Voltage	V _{OUT}	Load on OUT is an LED	0		3	V
OUT High Current	I _{OUTH}	V _{OUT} = 0.5V to 3V, V _{IN} = 10V	2	2.3		mA
OUT Low Current	I _{OUTL}	V _{IN} < V _{INTHL} , V _{OUT} = 0V	-1		+1	µA
OUT Voltage High	V _{OH}	3.0V ≤ V _{CC} ≤ 5.5V, I _{LOAD} = 1mA (Note 5)	V _{CC} - 0.4			V

DC Electrical Characteristics (continued)

$V_{IN} = 0V$ to $60V$, $V_{CC} = 0V$, $T_A = -40^{\circ}C$ to $+125^{\circ}C$, unless otherwise noted. Typical values are at $V_{IN} = 24V$, $R_{EXT} = 40.2k\Omega$ ($\pm 1\%$), and $T_A = +25^{\circ}C$. (Notes 2, 3)

PARAMETER	SYMBOL	CONDITIONS	MIN	TYP	MAX	UNITS
OUT Voltage Low	V_{OL}	$3.0V \leq V_{CC} \leq 5.5V$, $I_{SINK} = 1mA$ (Note 5)			0.4	V
AUXILIARY POWER SUPPLY (V_{CC})						
Auxiliary Power Supply Range	V_{CC}	(Note 6)	3.0		5.5	V
Auxiliary Power Supply Current	I_{CC}	$V_{CC} = 3.0V$		270	400	μA
		$V_{CC} = 5.5V$		380	600	
TEST INPUT						
TEST Input High Threshold	V_{TESTH}	$3.0V \leq V_{CC} \leq 5.5V$			$(2/3)V_{CC}$	V
		$V_{CC} = 0V$			2.8	
TEST Input Low Threshold	V_{TESTL}	$3.0V \leq V_{CC} \leq 5.5V$		$V_{CC}/3$		V
		$V_{CC} = 0V$		1.3		
TEST Input Pulldown Resistance	R_{PD}			250		$k\Omega$
PROTECTION						
Thermal Shutdown Threshold	T_{SHDN}	(Note 7)		160		$^{\circ}C$
Thermal Shutdown Hysteresis	T_{SHDN_HYS}			23		$^{\circ}C$
ESD (All Pins)		Human Body Model		± 2		kV

AC Electrical Characteristics

V_{IN} = 0V to 60V, V_{CC} = 0V, T_A = -40°C to +125°C, unless otherwise noted. Typical values are at V_{IN} = 24V, R_{EXT} = 40.2k Ω ($\pm 1\%$), and T_A = +25°C. (Note 2)

PARAMETER	SYMBOL	CONDITIONS		MIN	TYP	MAX	UNITS
IN to OUT Low-to-High Propagation Delay	t_{PDLH}	C_L = 15pF, Figure 1	V_{CC} = 0V, R_L = 1.5k Ω			250	ns
			V_{CC} = 3.0V, R_L is open			200	
IN to OUT High-to-Low Propagation Delay	t_{PDHL}	C_L = 15pF, Figure 1	V_{CC} = 0V, R_L = 1.5k Ω			250	ns
			V_{CC} = 3.0V, R_L is open			200	
IN to OUT Propagation Delay Jitter		C_L = 15pF, RMS jitter, Figure 1			250		ps
IN to OUT Propagation Delay Skew, Part-to-Part	$t_{SKEWP2P}$	C_L = 15pF, Figure 1 (Note 5)	V_{CC} = 0V, R_L = 1.5k Ω ,			195	ns
			$3.0V \leq V_{CC} \leq 5.5V$, R_L is open			75	
TEST Propagation Delay		V_{CC} = 0V or 3V, V_{IN} = 11V	TEST low to high, OUT high to low		1.5		μ s
			TEST high to low, OUT low to high		1.8		

Note 2: All units are production tested at T_A = +25°C. Specifications over temperature are guaranteed by design and characterization.

Note 3: All voltages are referenced to ground, unless otherwise noted.

Note 4: See the [Boost Current](#) section for more information.

Note 5: Not production tested. Guaranteed by design

Note 6: V_{CC} is an auxiliary supply input. When V_{CC} is powered from an external 3V to 5.5V supply, the propagation delay is reduced and the output changes from a current source to a CMOS output. When using power from IN to power the device, connect V_{CC} to GND (V_{CC} = 0V).

Note 7: Thermal shutdown protection is only enabled when V_{CC} is present. Thermal shutdown does not occur when V_{CC} = 0V.

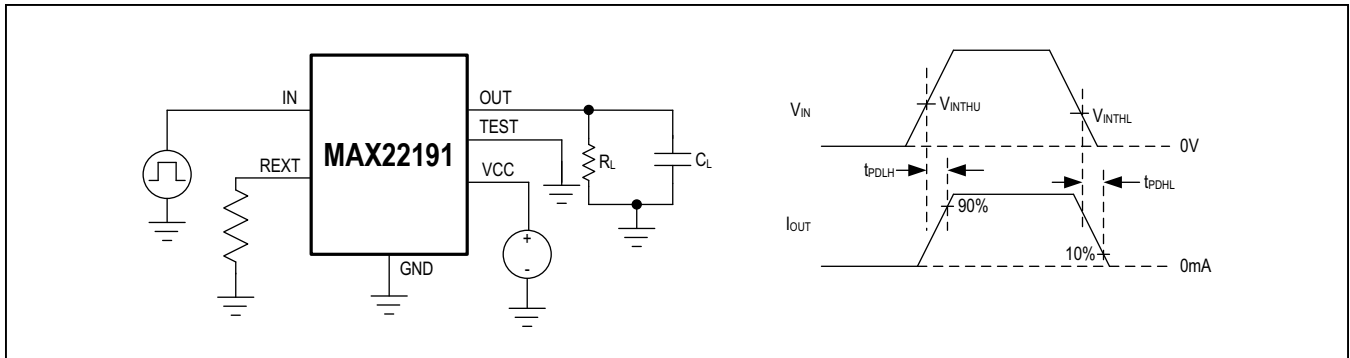
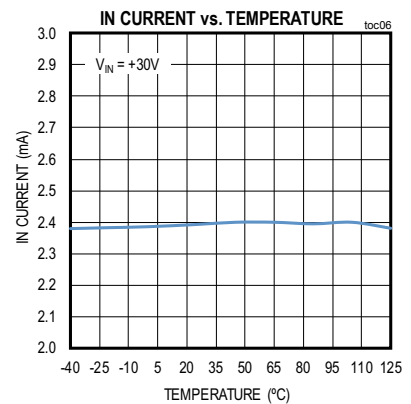
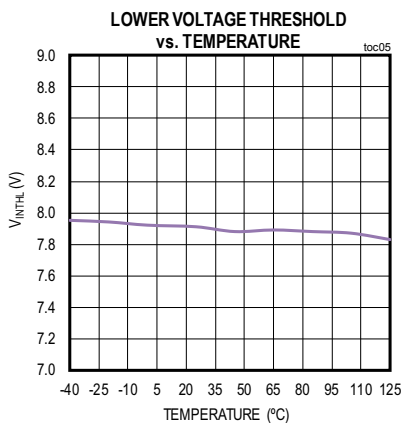
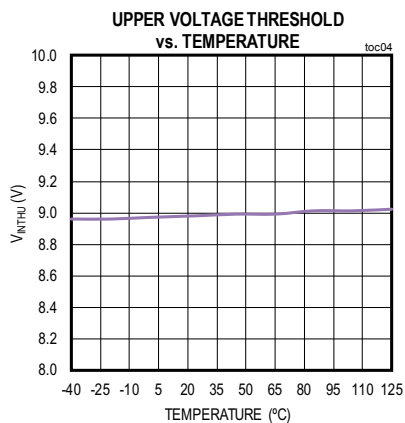
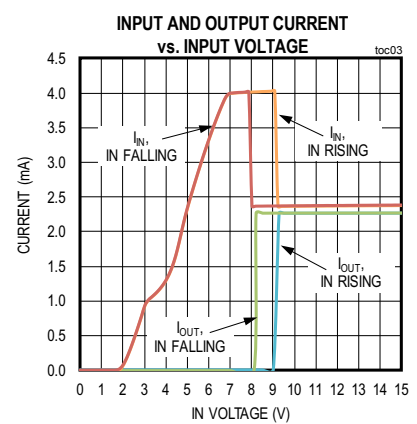
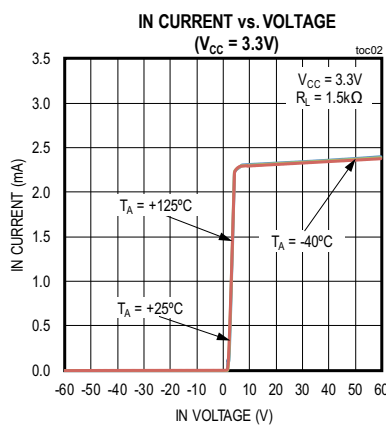
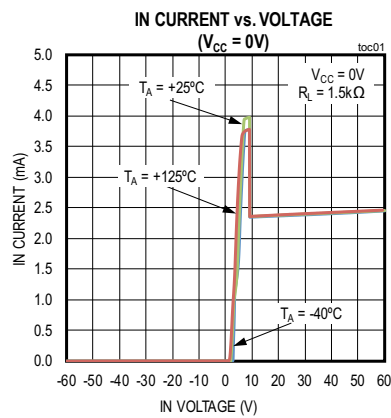

Figure 1. Propagation Delay Test Circuit and Timing Diagram

Typical Operating Characteristics

($V_{IN} = 24V$, $R_{EXT} = 40.2k\Omega$ ($\pm 1\%$), $R_L = 1.5k\Omega$ on OUT, $T_A = +25^\circ C$, unless otherwise noted.)



Typical Operating Characteristics (continued)

($V_{IN} = 24V$, $R_{EXT} = 40.2k\Omega$ ($\pm 1\%$), $R_L = 1.5k\Omega$ on OUT, $T_A = +25^\circ C$, unless otherwise noted.)

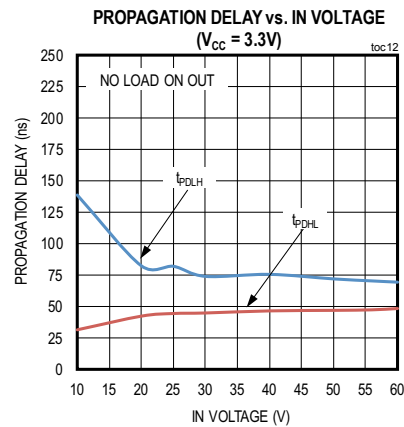
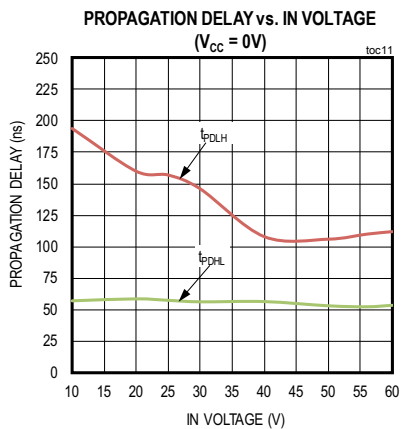
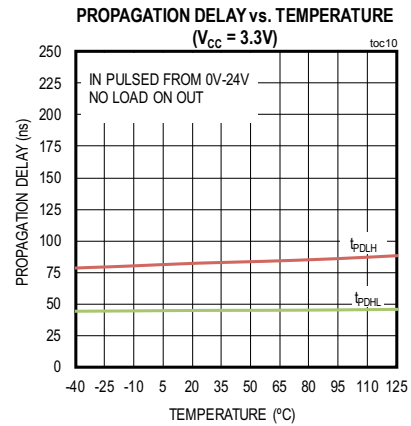
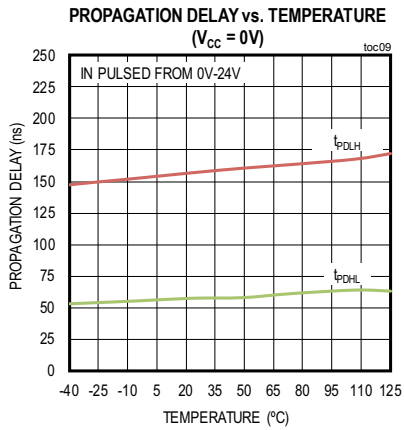
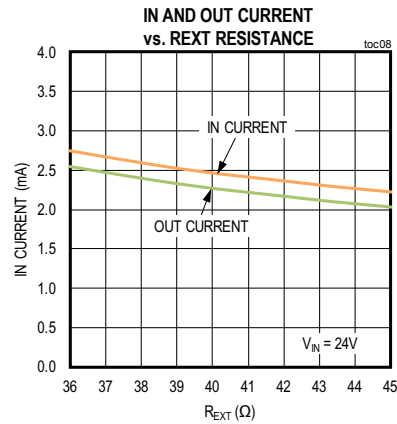
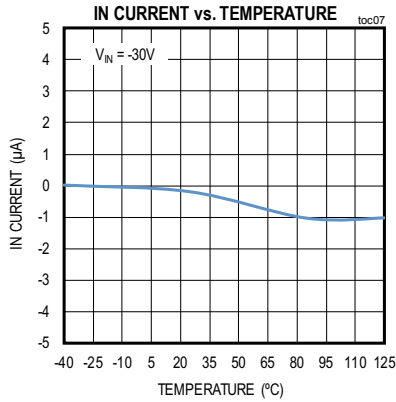

Pin Configurations

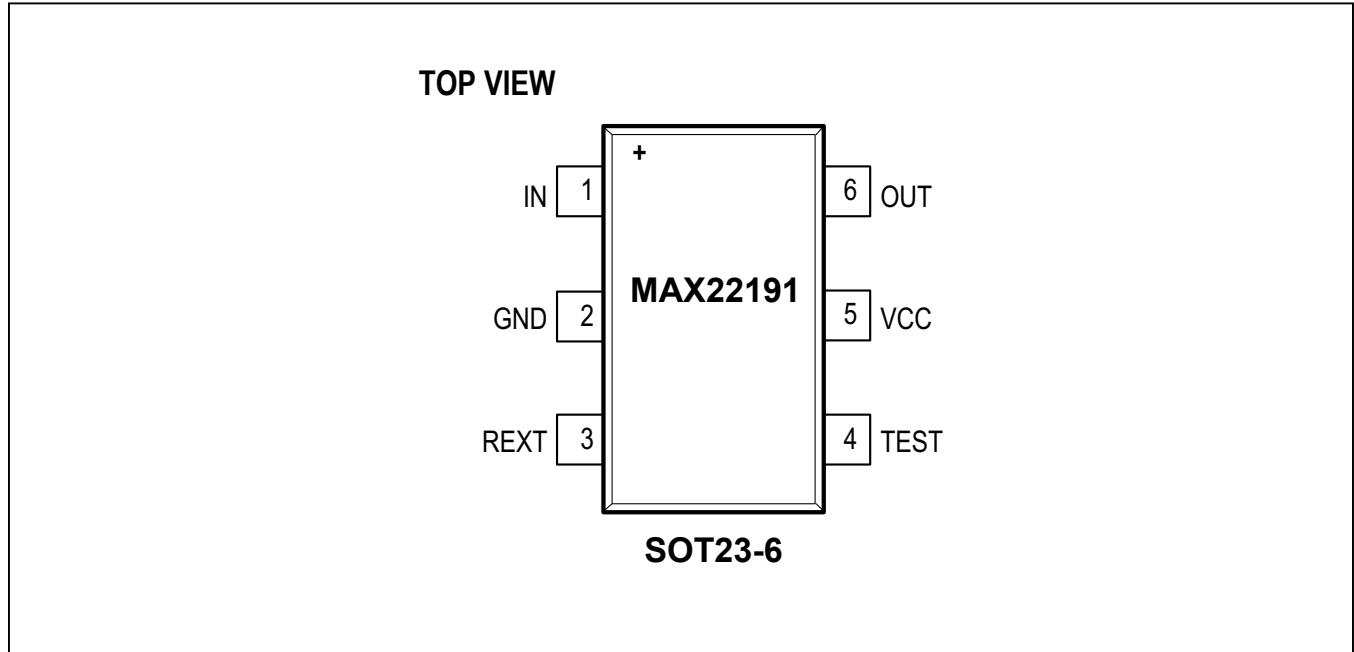

Pin Description

PIN	NAME	FUNCTION
1	IN	Digital Input. Connect IN directly to the input signal. Connect suitable TVS between IN and GND for surge protection.
2	GND	Ground
3	REXT	Reference Current Resistor Connection. Connect an external 40.2kΩ (±1%) resistor between REXT and GND.
4	TEST	Test Pulse Input. When IN is high, toggle TEST from low-to-high to verify that OUT toggles from high-to-low.
5	V _{CC}	Auxiliary Supply Input. For a parasitically powered circuit, connect V _{CC} to GND. To power the device from a local power supply, connect V _{CC} to a 3.0V to 5.5V source. Bypass V _{CC} to GND with a 1µF capacitor when powered from a local supply.
6	OUT	Output Signal. Connect OUT to the anode of an optical LED, or to the input of a digital circuit.

Detailed Description

The MAX22191 features an integrated current source, voltage comparator, and current steering network to create an input load compliant with IEC 61131-2 Type 1 and Type 3 24V_{DC} inputs, while generating a drive current for opto-isolators that turn-on/-off in compliance with the voltage thresholds of the standard. The addition of external voltage-dropping resistors also allows the MAX22191 to operate with 48V_{DC} inputs (see the [Typical Operating Circuits](#)).

Power-Up/Power-Down

As the input voltage (V_{IN}) rises, the MAX22191 transitions through three phases of operation:

Phase 1: V_{IN} is rising but is inadequate to fully power the current source or voltage comparator. Any current that does flow into the MAX22191 is diverted to GND through the internal current steering switches, bypassing the optical isolator.

Phase 2: V_{IN} continues to increase to a level that is adequate to power the comparator and the current source, but the input voltage threshold has not been reached. The output of the internal current source continues to be diverted to GND.

Phase 3: V_{IN} exceeds the comparator threshold (V_{INTHU}), and the current is switched to the OUT pin. If connected to an external optical isolator, the current passes through the LED and returns to the negative field input.

As V_{IN} drops, the phases are reversed. The internal current source is switched from OUT to GND when V_{IN} falls below the lower voltage threshold (V_{INTHL}).

Boost Current

To allow for a faster response time, the MAX22191 includes a boost current, I_{INB} , during IN power up. The boost current is used to set and stabilize the output current while the voltage on IN is rising ($V_{IN} < V_{INTHU}$). When $V_{IN} > V_{INTHU}$, and the output current is enabled, the input current is the sum of both the output current and boost current ($I_{INB} + I_{INH}$) for a short period before the output current is steady at 2.3mA (typ).

Integrated Diagnostic (TEST) Input

The MAX22191 features an integrated TEST input for easy diagnostic checks. When IN is high, toggle TEST from low-to-high to verify that OUT toggles high-to-low. See [Table 1](#). The current on IN is not affected during this diagnostic test.

When IN is low, TEST has no effect on OUT, it remains low.

Applications Information

Powering the MAX22191 With the V_{CC} Pin

The MAX22191 can be powered parasitically from a digital input or from an external power supply.

To power the device parasitically, connect V_{CC} to GND. In this configuration, power is derived from the signal on the IN pin.

To power the device from a local power supply, connect V_{CC} to a source between 3.0V and 5.5V. When V_{CC} is powered, the output (OUT) changes from a current source to a CMOS output and the propagation delay from IN to OUT is reduced.

Layout Considerations

Place the 40.2k Ω ($\pm 1\%$) REXT resistor as close to the pin as possible. Too much distance between the resistor and the IC can create unwanted input current overshoots/undershoots.

Table 1. TEST Mode Functionality

IN	TEST	OUT
$< V_{INTHL}$	Low	Low
$< V_{INTHL}$	High	Low
$\geq V_{INTHU}$	Low	High
$\geq V_{INTHU}$	High	Low

Typical Operating Circuits

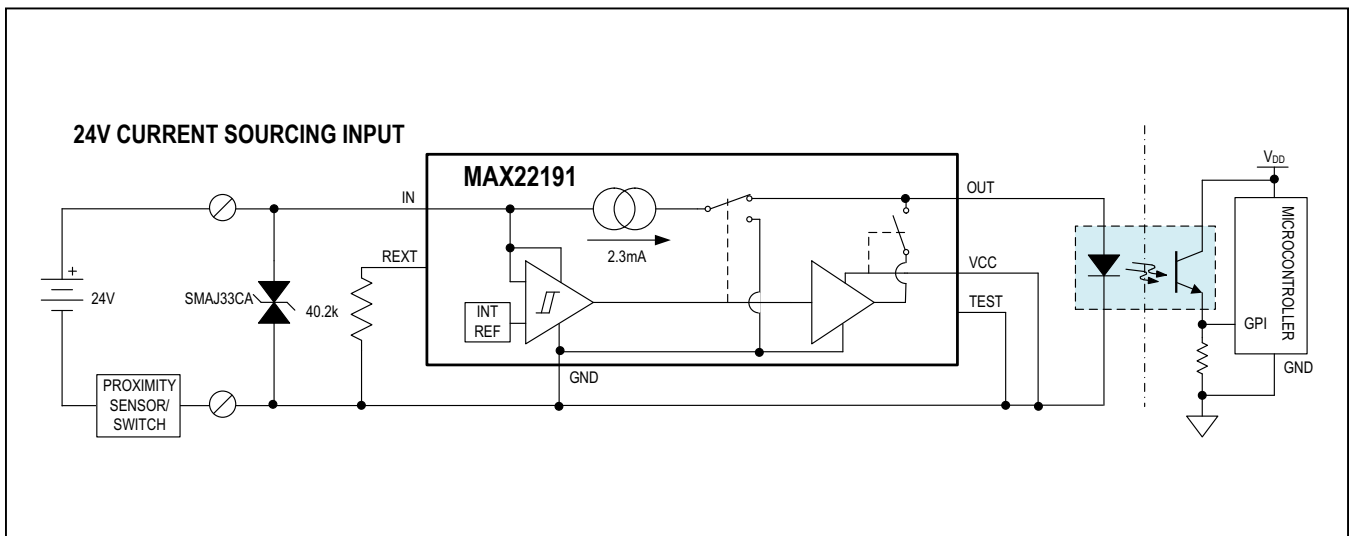
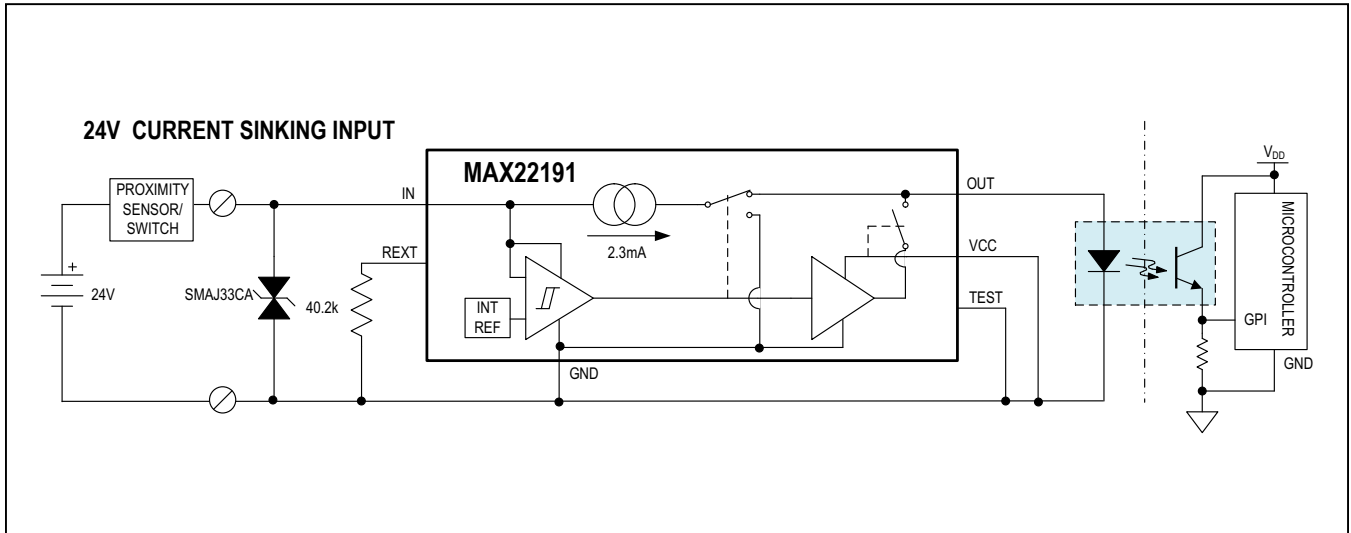

Typical Operating Circuits (continued)

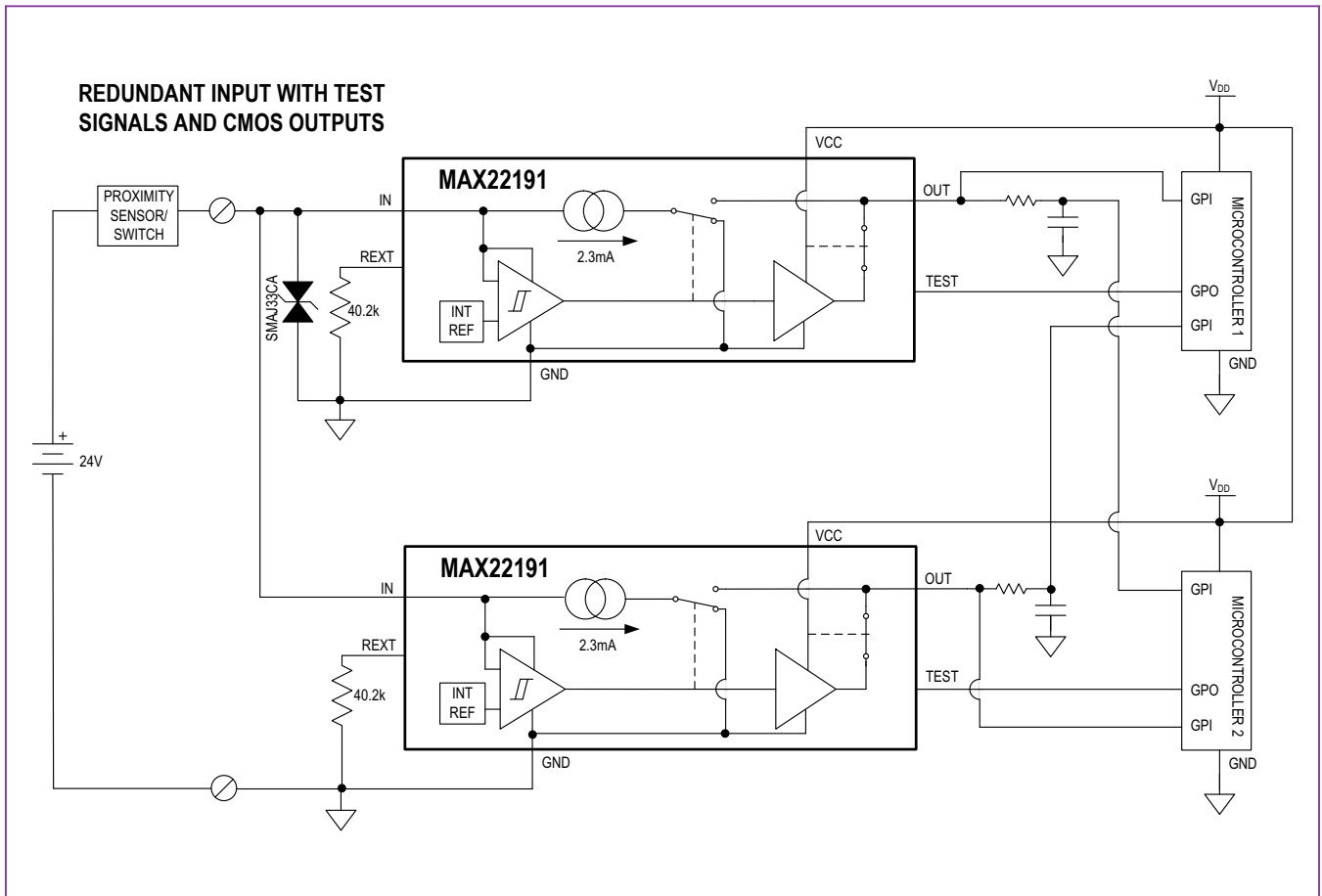
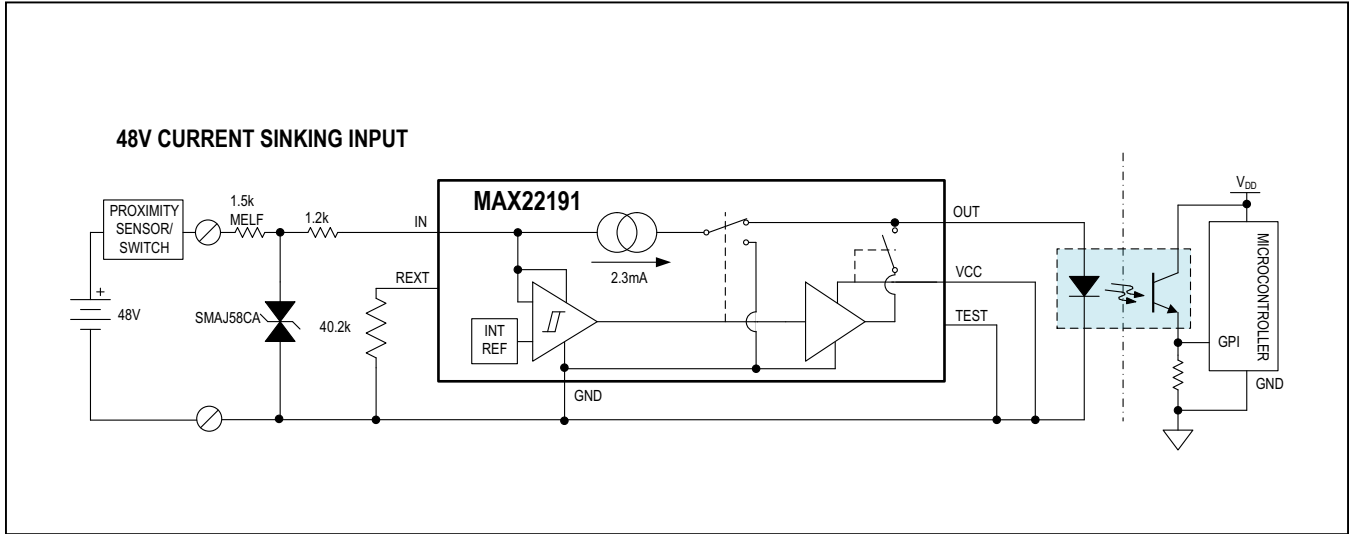

Chip Information

PROCESS: BICMOS

Ordering Information

PART	TEMP RANGE	PIN-PACKAGE
MAX22191AUT+	-40°C to +125°C	6 SOT23

+Denotes a lead(Pb)-free/RoHS-compliant package.

T = Tape and reel.

Package Information

For the latest package outline information and land patterns (footprints), go to www.maximintegrated.com/packages. Note that a "+", "#", or "-" in the package code indicates RoHS status only. Package drawings may show a different suffix character, but the drawing pertains to the package regardless of RoHS status.

PACKAGE TYPE	PACKAGE CODE	OUTLINE NO.	LAND PATTERN NO.
6-SOT23	U6-1	21-0058	90-0175

Revision History

REVISION NUMBER	REVISION DATE	DESCRIPTION	PAGES CHANGED
0	12/17	Initial release	—

For pricing, delivery, and ordering information, please contact Maxim Direct at 1-888-629-4642, or visit Maxim Integrated's website at www.maximintegrated.com.

Maxim Integrated cannot assume responsibility for use of any circuitry other than circuitry entirely embodied in a Maxim Integrated product. No circuit patent licenses are implied. Maxim Integrated reserves the right to change the circuitry and specifications without notice at any time. The parametric values (min and max limits) shown in the Electrical Characteristics table are guaranteed. Other parametric values quoted in this data sheet are provided for guidance.