

ETD-SL-1T-DTF

Multifunctional timer relay with one adjustable time

Data sheet
102571_en_06

© PHOENIX CONTACT - 2013-05-31



1 Description

Increasingly higher demands are being placed on safety and system availability – across all sectors. Processes are becoming more and more complex, not only in mechanical engineering and the chemical industry, but also in plant and automation technology. Demands on power engineering are also increasing constantly.

The timer relays in the ETD series can be used to control time sequences in production and process technology.

Features

- One adjustable time
- Time range of 50 ms to 100 hours (seven setting ranges)
- Non-floating control input
- Delay functions
- Wiper functions
- Flashing function
- Wide-range power supply unit
- Two floating PDTs



WARNING: Risk of electric shock

Never carry out work when voltage is present.



Make sure you always use the latest documentation.

It can be downloaded from the product at phoenixcontact.net/products.

2 Ordering data

Description	Type	Order No.	Pcs. / Pkt.
Multifunctional timer relay with one adjustable time	ETD-SL-1T-DTF	2866161	1

3 Technical data

Input data	
Input voltage range	24 V DC ... 240 V DC -20 % ... +25 % 24 V AC ... 240 V AC -15 % ... +10 %
Nominal frequency	48 Hz ... 63 Hz
Temperature coefficient, typical	≤ 0.01 %/K
Recovery time	500 ms
Time setting range	50 ms ... 100 h (7 time end ranges)
Function	E: With switch-on delay R: With release delay and control contact Es: With switch-on delay and control contact Wu: With single shot leading edge, voltage controlled Ws: With single shot leading edge and control contact Wa: With single shot trailing edge and control contact Bi: Flashing beginning with pulse Bp: Flashing beginning with pause
Basic accuracy	± 1 % (of scale end value)
Setting accuracy	≤ 5 % (of scale end value)
Repeat accuracy	≤ 0.5 % ±5 ms
Nominal power consumption	2.5 VA (1 W)
Output data	
Contact type	2 floating PDT contacts
Nominal insulation voltage	250 V AC (in acc. with IEC 60664-1)
Interrupting rating (ohmic load) max.	750 VA (3 A/250 V AC, module aligned, ≤ 5 mm spacing) 1250 VA (5 A/250 V AC, module not aligned, ≥ 5 mm spacing)
Output fuse	5 A (fast-blow)
Control contact	
Control contact	Non-floating, terminals A1-B1
Load capacity	Parallel switched minimum load current 1 VA (0.5 W), terminals A2-B1
Control pulse length	min. 70 ms
General data	
Mechanical service life	Approx. 2×10^7 cycles
Service life, electrical	Approx. 2×10^5 cycles at ohmic load, 1000 VA
Switching frequency	max. 60 (per minute at 100 VA ohmic load) max. 6 (per minute at 1000 VA ohmic load)
Operating mode	100% operating factor
Degree of protection	IP40 (housing) / IP20 (connection terminal blocks)
Pollution degree	2 (according to EN 50178)
Surge voltage category	III, basic insulation (as per EN 50178)
Rated insulation voltage	300 V (According to EN 50178)
Inflammability class according to UL 94	V0
Mounting	on standard DIN rail NS 35 in accordance with EN 60715
Mounting position	Any
Width	22.5 mm

General data [...]

Height	90 mm
Depth	113 mm
Type of housing	Polyamide PA, self-extinguishing
Color	green
Weight	160 g

Connection data

Conductor cross section, solid	0.5 mm ² ... 2.5 mm ²
Conductor cross section, stranded	0.5 mm ² ... 2.5 mm ²
Stripping length	8 mm
Connection method	Screw connection
Tightening torque	1 Nm

Ambient conditions

Ambient temperature (operation)	-25 °C ... 55 °C -25 °C ... 40 °C (corresponds to UL 508)
Ambient temperature (storage/transport)	-25 °C ... 70 °C
Permissible humidity (operation)	15 % ... 85 %
Climatic class	3K3 (in acc. with EN 60721)

Conformance / approvals

Conformance	CE-compliant
UL, USA / Canada	UL/C-UL listed UL 508

Conformance with EMC Directive 2004/108/EC

Noise immunity according to	EN 61000-6-2
Noise emission according to	EN 61000-6-4

Conformance with LV directive 2006/95/EC

Industrial timer relays according to	EN 61812-1/A11
--------------------------------------	----------------

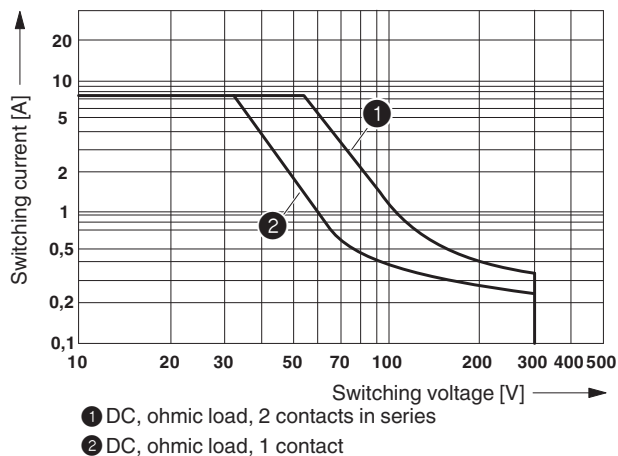
4 DC breaking capacity

5 Block diagram

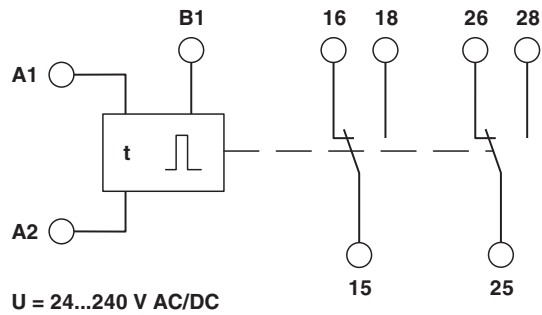

6 Safety notes



WARNING: Risk of electric shock

Never carry out work when voltage is present.

7 Structure

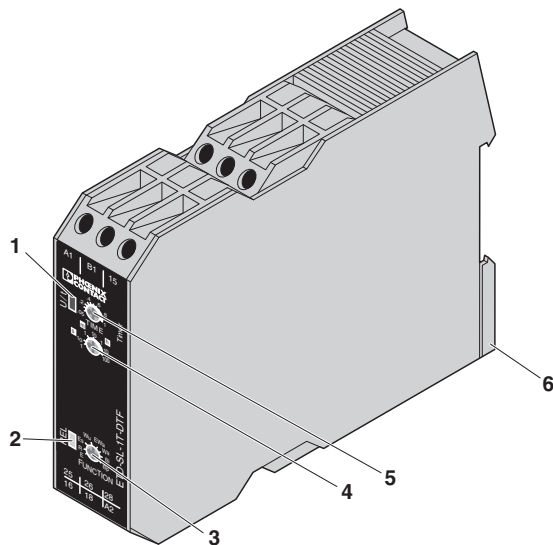

- 1 "U/t" LED: Supply and adjustable time TIME
- 2 "REL" LED: Output relay
- 3 "FUNCTION" rotary switch: Function selection
- 4 Rotary switch "TIME": Time end range
- 5 "TIME" potentiometer: Preset value
- 6 Universal snap-on foot for EN DIN rails

8 Installation



WARNING: Risk of electric shock

Never carry out work when voltage is present.

The module can be snapped onto all 35 mm DIN rails according to EN 60715.

An integrated wide-range power supply unit enables the connection of a supply voltage in the range from 24 V AC/DC to 240 V AC/DC.

9 Time setting

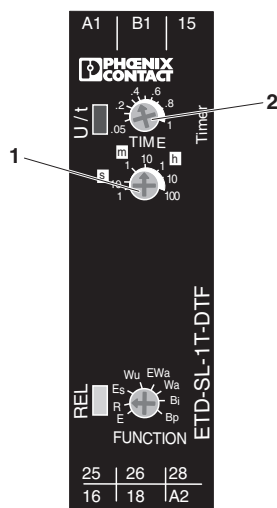

Example:

- 1 Specification of the time end range using a rotary switch, e.g. 10 m (10 minutes)
- 2 Fine setting of the time using a potentiometer, e.g. 0.4

Set time: 0.4 x 10 minutes = 4 minutes

10 Diagnostics

The LEDs indicate the following error states:

"U/t" LED (Green)

- LED flashes: Voltage present, set time running
- LED ON: Voltage present, set time has elapsed

"REL" LED (Yellow)

- LED ON: Output relay has picked up
- LED OFF: Output relay has dropped out

11 Connection examples

NOTE:

When the control input is connected to a parallel load, ensure that the minimum load connected in parallel is > 1 VA.

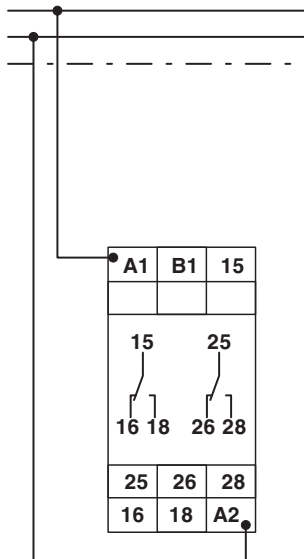

Connection without control contact

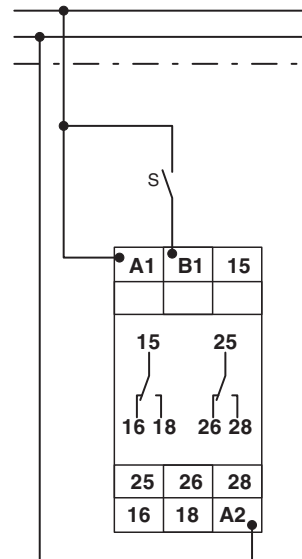

Connection with control contact

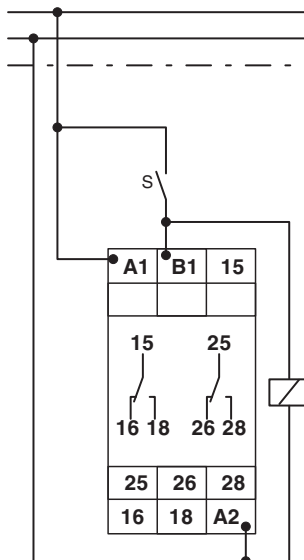

Connection with control contact and parallel load (e.g., relay)

12 Function



NOTE: Module can become damaged

Only set the functions when the module is switched off.

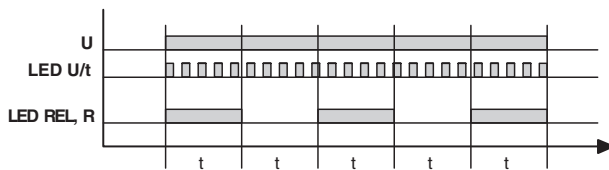

Bi: Flashing Beginning With Pulse

When supply voltage U is applied, the output relay picks up (yellow "REL" LED is ON) and set time t starts running (green "U/t" LED flashes). Once time t has elapsed, the output relay drops out (yellow "REL" LED is OFF) and set time t starts running again. The output relay is controlled at a ratio of 1:1, until the supply voltage is interrupted.

For the flashing function the pulse and pause times are the same, as it is only possible to set one time.

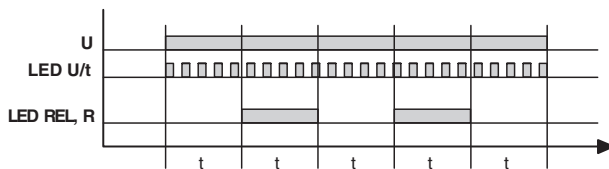

Bp: Flashing Beginning With Pause

When supply voltage U is applied, set time t starts running (green "U/t" LED flashes). Once time t has elapsed, the output relay picks up (yellow "REL" LED is ON) and set time t starts running again. Once time t has elapsed, the output relay drops out (yellow "REL" LED is OFF). The output relay is controlled at a ratio of 1:1, until the supply voltage is interrupted.

For the flashing function the pulse and pause times are the same, as it is only possible to set one time.

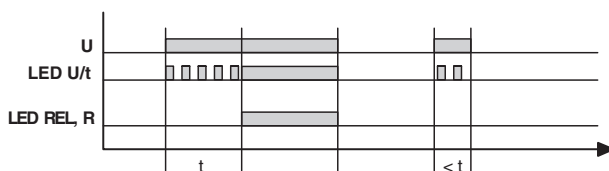

E: With Switch-On Delay

When supply voltage U is applied, set time t starts running (green "U/t" LED flashes). Once time t has elapsed (green "U/t" LED is ON), the output relay picks up (yellow "REL" LED is ON). This state is maintained until supply voltage U is interrupted. If supply voltage U is interrupted before time t has elapsed, the elapsed time is deleted (relay does not pick up). The next time supply voltage U is applied, the time is restarted.

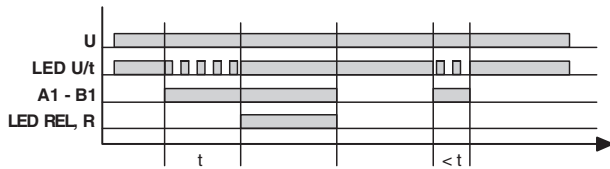

Es: With Switch-On Delay and Control Contact

Supply voltage U must be applied permanently at the device (green "U/t" LED is ON). When control contact A1-B1 is closed, set time t starts running (green "U/t" LED flashes). Once time t has elapsed (green "U/t" LED is ON), the output relay picks up (yellow "REL" LED is ON). This state is maintained until the control contact is opened. If the control contact is opened before time t has elapsed, the elapsed time is deleted (relay does not pick up) and restarted with the next cycle.

R: With Release Delay and Control Contact

Supply voltage U must be applied permanently at the device (green "U/t" LED is ON). When control contact A1-B1 is closed, the output relay picks up (yellow "REL" LED is ON). If control contact A1-B1 is opened, set time t starts running (green "U/t" LED flashes). Once time t has elapsed (green "U/t" LED is ON), the output relay drops out (yellow "REL" LED is OFF). If the control contact is closed again before time t has elapsed, the elapsed time is deleted and restarted with the next cycle.

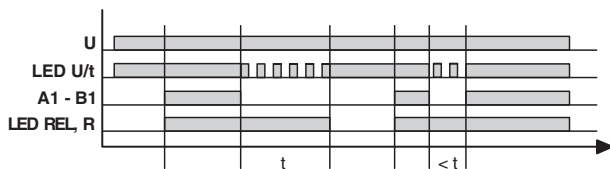

Wu: With single shot leading edge, voltage controlled

When supply voltage U is applied, the output relay picks up (yellow "REL" LED is ON) and set time t starts running (green "U/t" LED flashes). Once time t has elapsed (green "U/t" LED is ON), the output relay drops out (yellow "REL" LED is OFF). This state is maintained until supply voltage U is interrupted. If the supply voltage is interrupted before time t has elapsed, the output relay drops out. The elapsed time is deleted and restarted the next time the supply voltage is applied again.

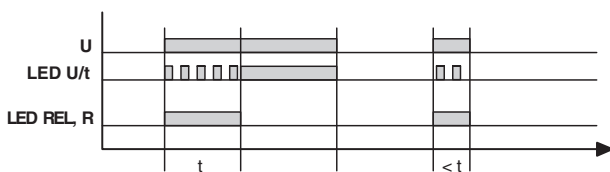

Ws: With single shot leading edge and control contact

Supply voltage U must be applied permanently at the device (green "U/t" LED is ON). When control contact A1-B1 is closed, the output relay picks up (yellow "REL" LED is ON) and set time t starts running (green "U/t" LED flashes). Once time t has elapsed (green "U/t" LED is ON), the output relay drops out (yellow "REL" LED is OFF).

The control contact can be freely switched during this time. Another cycle cannot be started until the current cycle has been completed.

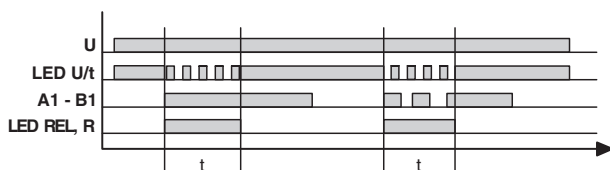

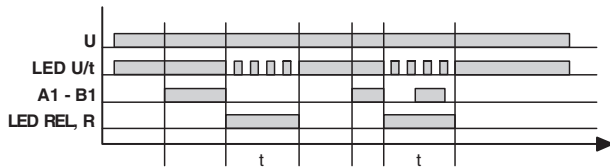

Wa: With single shot trailing edge and control contact

Supply voltage U must be applied permanently at the device (green "U/t" LED is ON). Control contact A1-B1 closing has no influence on the position of the output relay. When control contact A1-B1 is opened, the output relay picks up (yellow "REL" LED is ON) and set time t starts running (green "U/t" LED flashes). Once time t has elapsed (green "U/t" LED is ON), the output relay drops out (yellow "REL" LED is OFF). The control contact can be freely switched during this time. Another cycle cannot be started until the current cycle has been completed.