

GNSS patch antenna

1.57542GHz / 1.598-1.606GHz

W3216

Series : **ANTENNA**

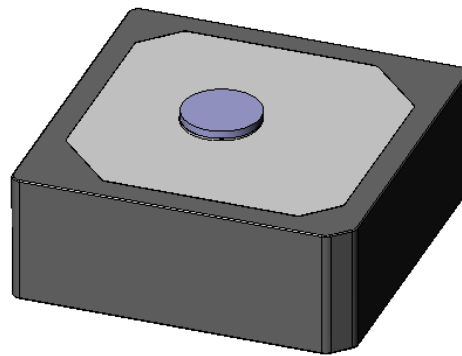

All dimensions are in inches (mm)

Issue: 1444

In the effort to improve our products, we reserve the right to make changes judged to be necessary.

CONFIDENTIAL AND PROPRIETARY INFORMATION

This document contains confidential and proprietary information of Pulse Electronics, Inc. (Pulse) and is protected by copyright, trade secret and other state and federal laws. Its receipt or possession does not convey any rights to reproduce, disclose its contents, or to manufacture, use or sell anything it may describe. Reproduction, disclosure or use without specific written authorization of Pulse is strictly forbidden

FM50039 Rev 0, 5/2/2013



GNSS patch antenna

1.57542GHz / 1.598-1.606GHz

W3216

Series : **ANTENNA**

*) Typical performance (measured on 50x50mm ground plane)

ELECTRICAL SPECIFICATIONS *)

Frequency	1.57542 / 1.598-1.606	GHz
Nominal Impedance	50	Ω
RHCP Zenith Gain @ 1.57542GHz	-2	dBic
RHCP Zenith Gain @ 1.598-1.606GHz	-2	dBic
Combined Zenith Gain @ 1.57542GHz	2	dBi
Combined Zenith Gain @ 1.598-1.606GHz	2	dBi
Efficiency @ 1.57542GHz	60	%
Efficiency @ 1.598-1.606GHz	60	%
Polarization		RHCP

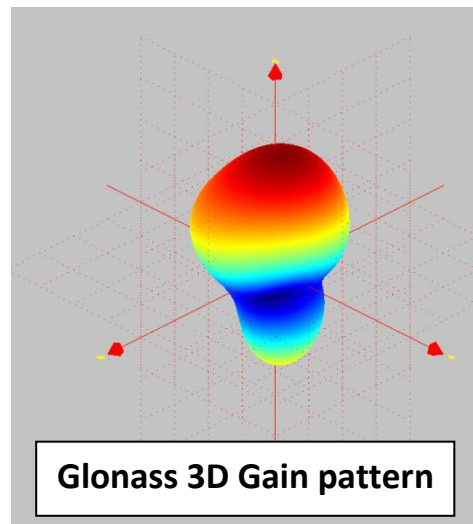
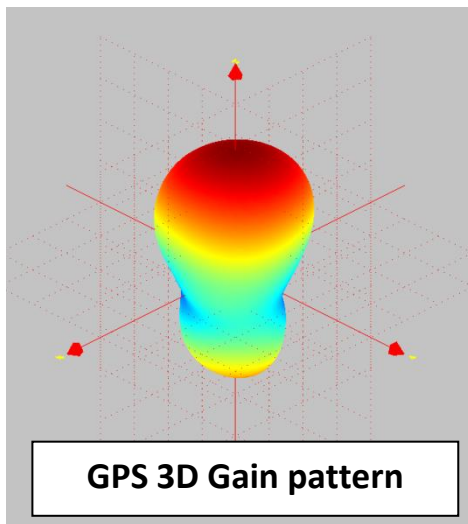

Issue: 1444

In the effort to improve our products, we reserve the right to make changes judged to be necessary.

CONFIDENTIAL AND PROPRIETARY INFORMATION

This document contains confidential and proprietary information of Pulse Electronics, Inc. (Pulse) and is protected by copyright, trade secret and other state and federal laws. Its receipt or possession does not convey any rights to reproduce, disclose its contents, or to manufacture, use or sell anything it may describe. Reproduction, disclosure or use without specific written authorization of Pulse is strictly forbidden.

GNSS patch antenna

1.57542GHz / 1.598-1.606GHz

W3216

Series : **ANTENNA**

Antenna Dimensions

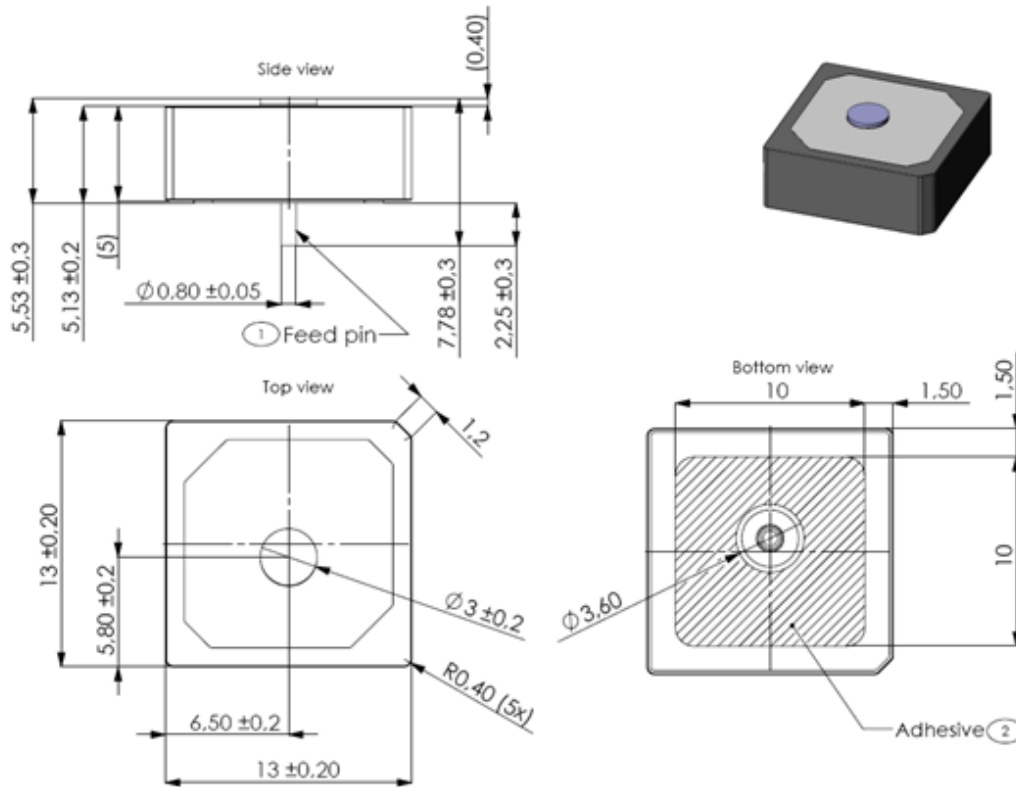

No.	Item	Description
1	Feed pin	Silver plated brass
2	Adhesive	0.13 mm thick double sided tape

Notes:

Feed pin manual soldering conditions:

- 300°C max soldering iron temperature, 5 seconds max
- Typical lead free solders are applicable

Electrode silver metallization may tarnish if antenna is stored / used in corrosive environment especially where chloride, sulphur or sulfide, alkali or acid salts exist in the air. Corrosive gases may cause oxidation of electrodes and reduce solderability

Issue: 1444

In the effort to improve our products, we reserve the right to make changes judged to be necessary.

CONFIDENTIAL AND PROPRIETARY INFORMATION

This document contains confidential and proprietary information of Pulse Electronics, Inc. (Pulse) and is protected by copyright, trade secret and other state and federal laws. Its receipt or possession does not convey any rights to reproduce, disclose its contents, or to manufacture, use or sell anything it may describe. Reproduction, disclosure or use without specific written authorization of Pulse is strictly forbidden

GNSS patch antenna**1.57542GHz / 1.598-1.606GHz****W3216**Series : **ANTENNA****MECHANICAL SPECIFICATIONS**

Color	Grey
Size (WxLxH)	13x13x5 mm
RoHS Compliance	Yes

ENVIRONMENTAL SPECIFICATIONS

Operating temperature	-40...+85 °C
-----------------------	--------------

TRAY PACKING SPECIFICATIONS

100pcs antennas per tray
17pcs trays per box
one empty tray per box
1600pcs antennas per box
Box size 520*368*264mm

Issue: 1444

In the effort to improve our products, we reserve the right to make changes judged to be necessary.

CONFIDENTIAL AND PROPRIETARY INFORMATION

This document contains confidential and proprietary information of Pulse Electronics, Inc. (Pulse) and is protected by copyright, trade secret and other state and federal laws. Its receipt or possession does not convey any rights to reproduce, disclose its contents, or to manufacture, use or sell anything it may describe. Reproduction, disclosure or use without specific written authorization of Pulse is strictly forbidden



GNSS patch antenna

1.57542GHz / 1.598-1.606GHz

W3216

Series : ANTENNA

Charts

(Return Loss)

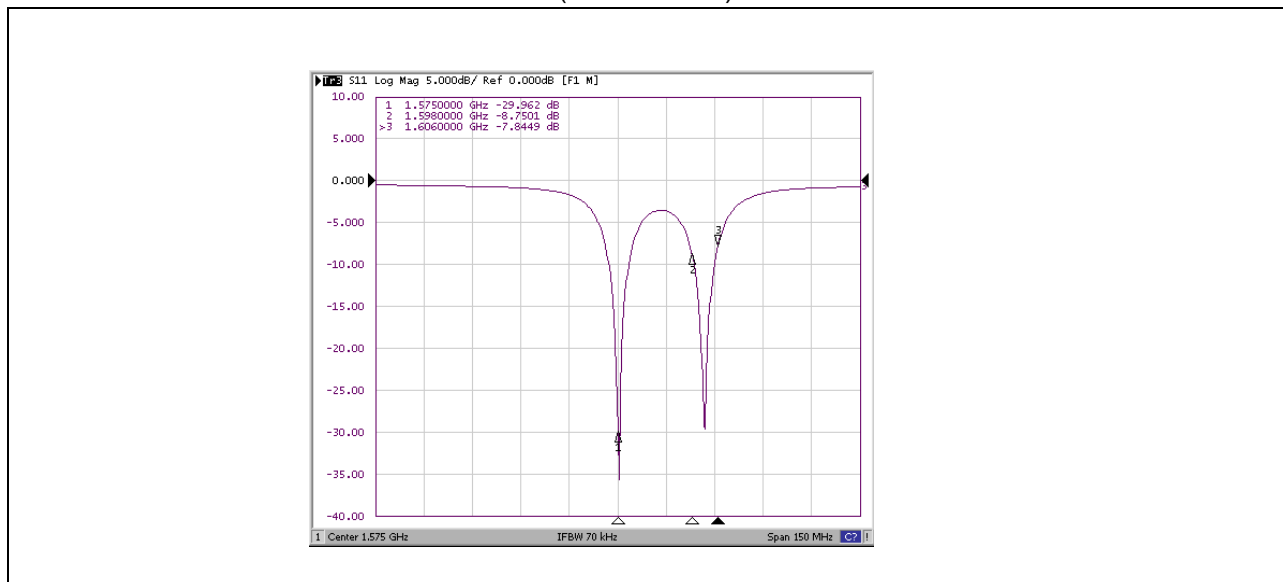

(Impedance)

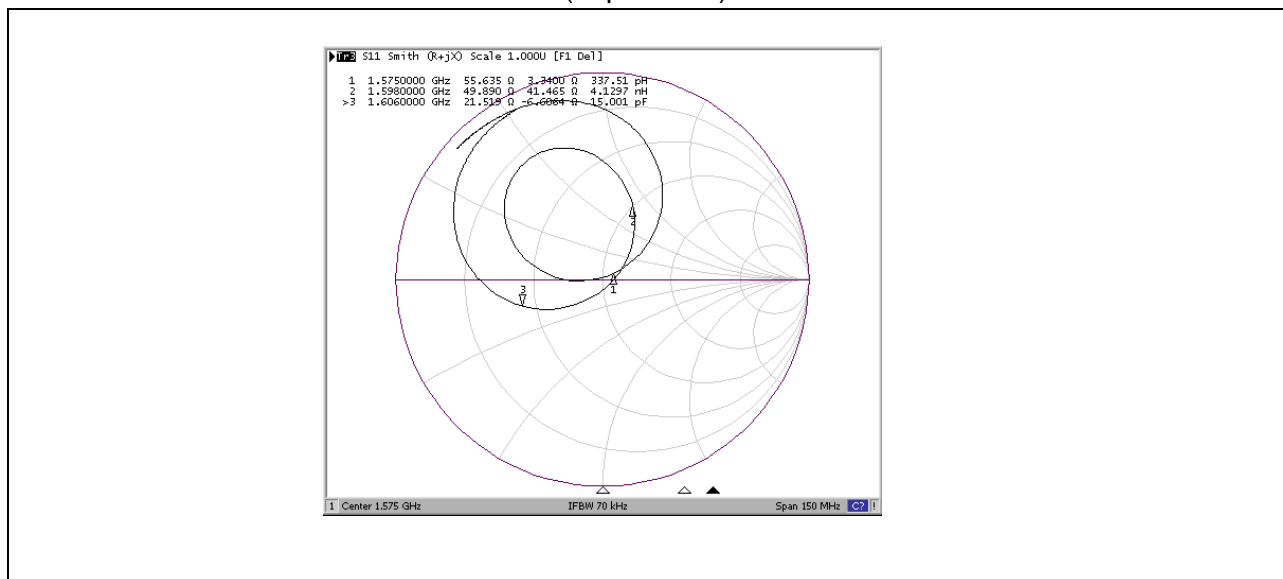

Issue: 1444

In the effort to improve our products, we reserve the right to make changes judged to be necessary.

CONFIDENTIAL AND PROPRIETARY INFORMATION

This document contains confidential and proprietary information of Pulse Electronics, Inc. (Pulse) and is protected by copyright, trade secret and other state and federal laws. Its receipt or possession does not convey any rights to reproduce, disclose its contents, or to manufacture, use or sell anything it may describe. Reproduction, disclosure or use without specific written authorization of Pulse is strictly forbidden

FM50039 Rev 0, 5/2/2013



GNSS patch antenna

1.57542GHz / 1.598-1.606GHz

W3216

Series : **ANTENNA**

(Free space Efficiency)

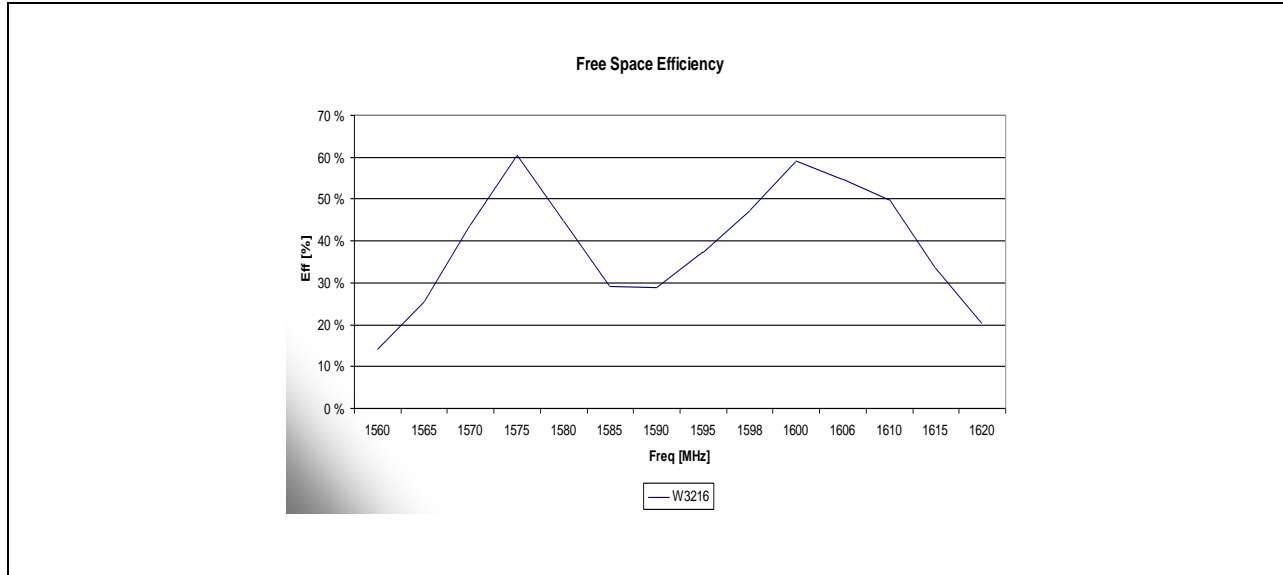

(Free space RHCP gain)

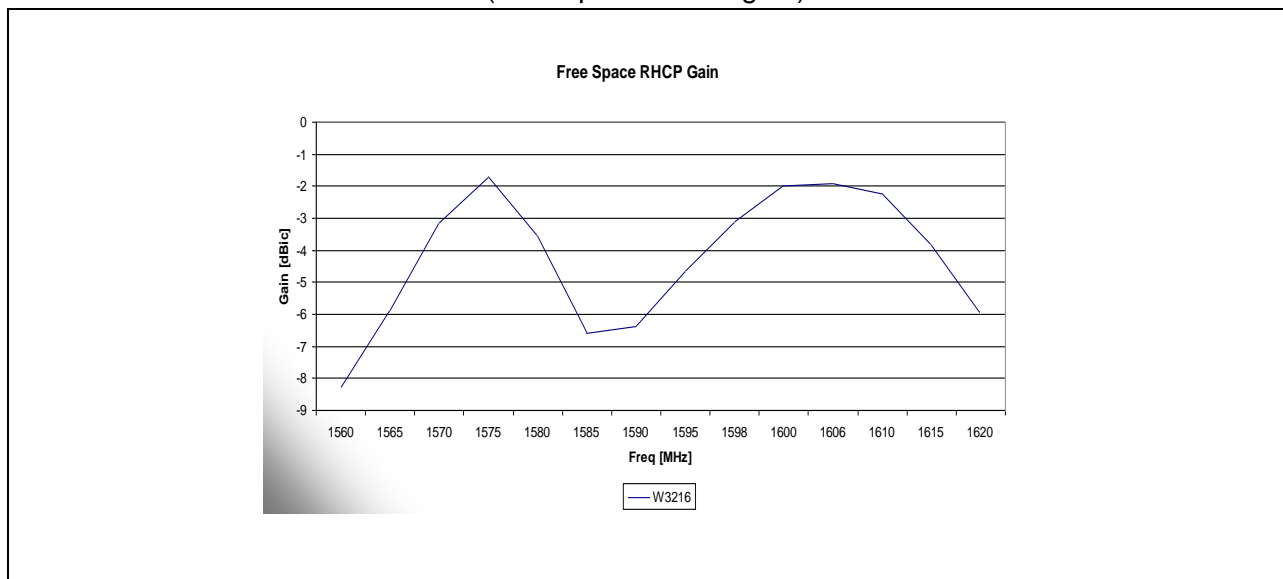

Issue: 1444

In the effort to improve our products, we reserve the right to make changes judged to be necessary.

CONFIDENTIAL AND PROPRIETARY INFORMATION

This document contains confidential and proprietary information of Pulse Electronics, Inc. (Pulse) and is protected by copyright, trade secret and other state and federal laws. Its receipt or possession does not convey any rights to reproduce, disclose its contents, or to manufacture, use or sell anything it may describe. Reproduction, disclosure or use without specific written authorization of Pulse is strictly forbidden



GNSS patch antenna

1.57542GHz / 1.598-1.606GHz

W3216

Series : **ANTENNA**

(GPS Elevation plane combined gain)

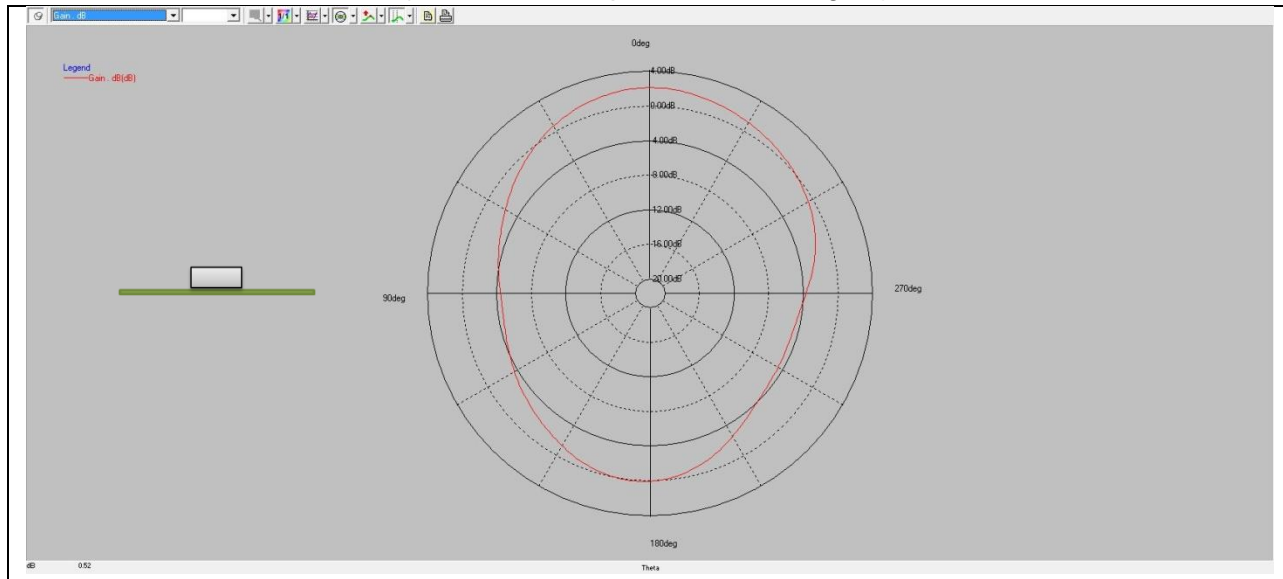

(GPS Azimuth plane combined gain, conical 45degree)

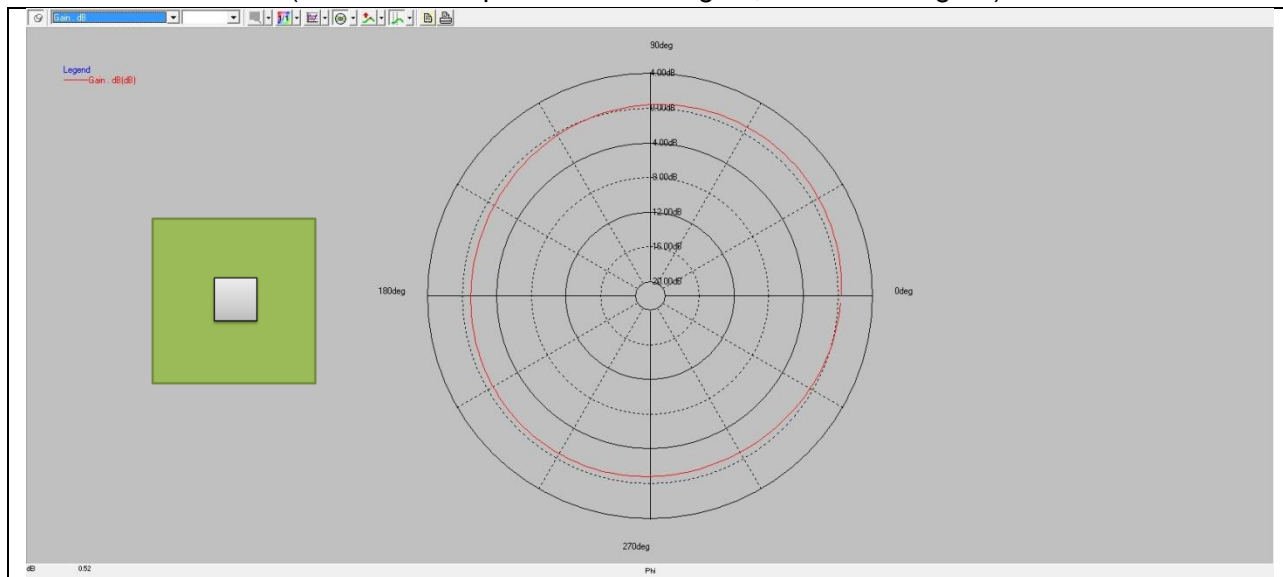

Issue: 1444

In the effort to improve our products, we reserve the right to make changes judged to be necessary.

CONFIDENTIAL AND PROPRIETARY INFORMATION

This document contains confidential and proprietary information of Pulse Electronics, Inc. (Pulse) and is protected by copyright, trade secret and other state and federal laws. Its receipt or possession does not convey any rights to reproduce, disclose its contents, or to manufacture, use or sell anything it may describe. Reproduction, disclosure or use without specific written authorization of Pulse is strictly forbidden



GNSS patch antenna

1.57542GHz / 1.598-1.606GHz

W3216

Series : **ANTENNA**

(GPS Elevation plane RHCP gain)

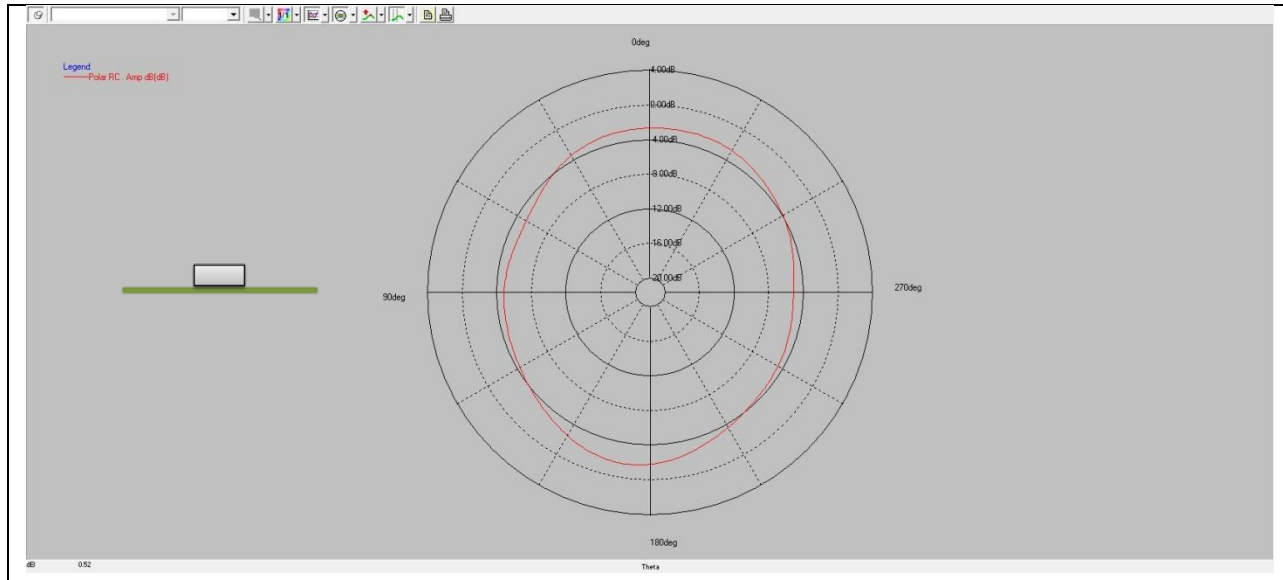

(GPS Azimuth plane RHCP gain, conical 45degree)

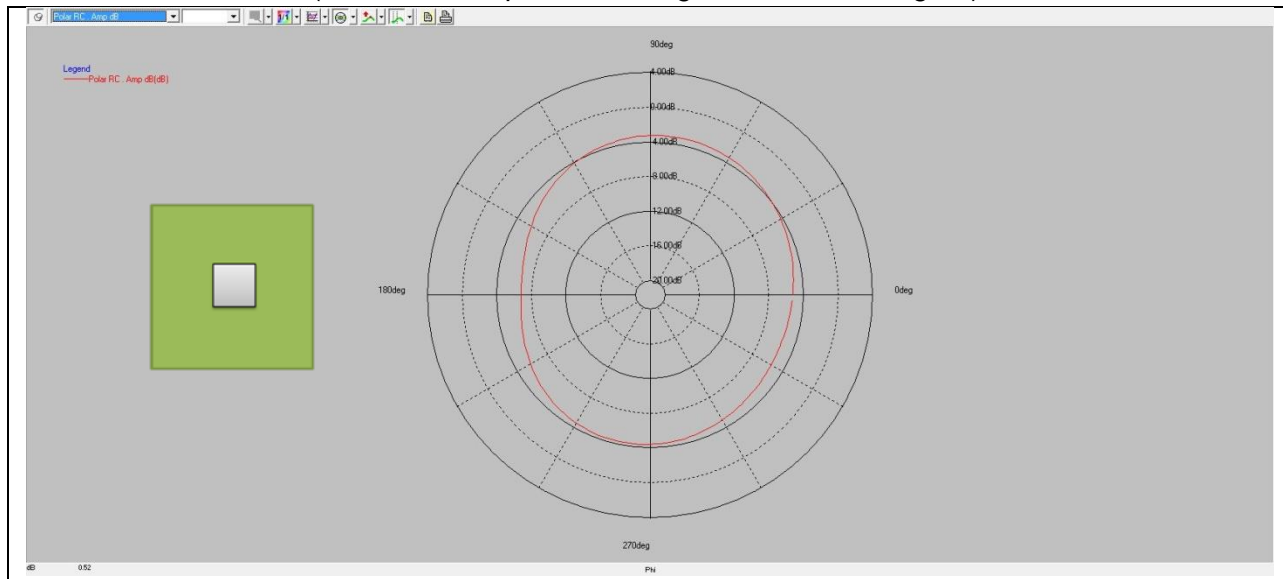

Issue: 1444

In the effort to improve our products, we reserve the right to make changes judged to be necessary.

CONFIDENTIAL AND PROPRIETARY INFORMATION

This document contains confidential and proprietary information of Pulse Electronics, Inc. (Pulse) and is protected by copyright, trade secret and other state and federal laws. Its receipt or possession does not convey any rights to reproduce, disclose its contents, or to manufacture, use or sell anything it may describe. Reproduction, disclosure or use without specific written authorization of Pulse is strictly forbidden

FM50039 Rev 0, 5/2/2013



GNSS patch antenna

1.57542GHz / 1.598-1.606GHz

W3216

Series : **ANTENNA**

(Glonass Elevation plane combined gain)

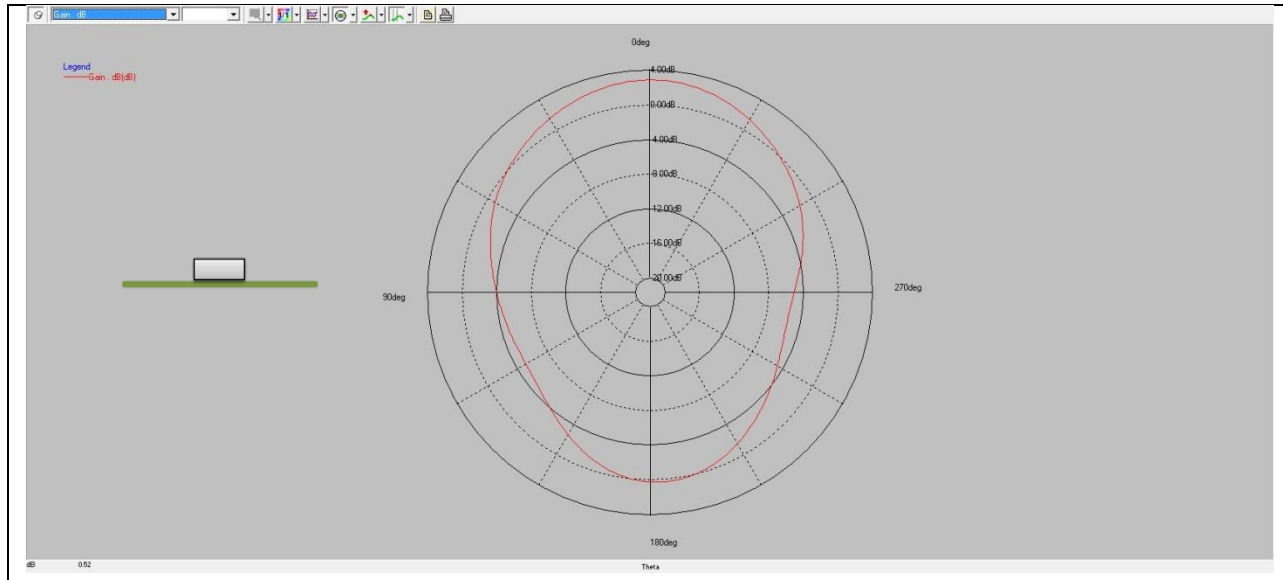

(Glonass Azimuth plane combined gain, conical 45degree)

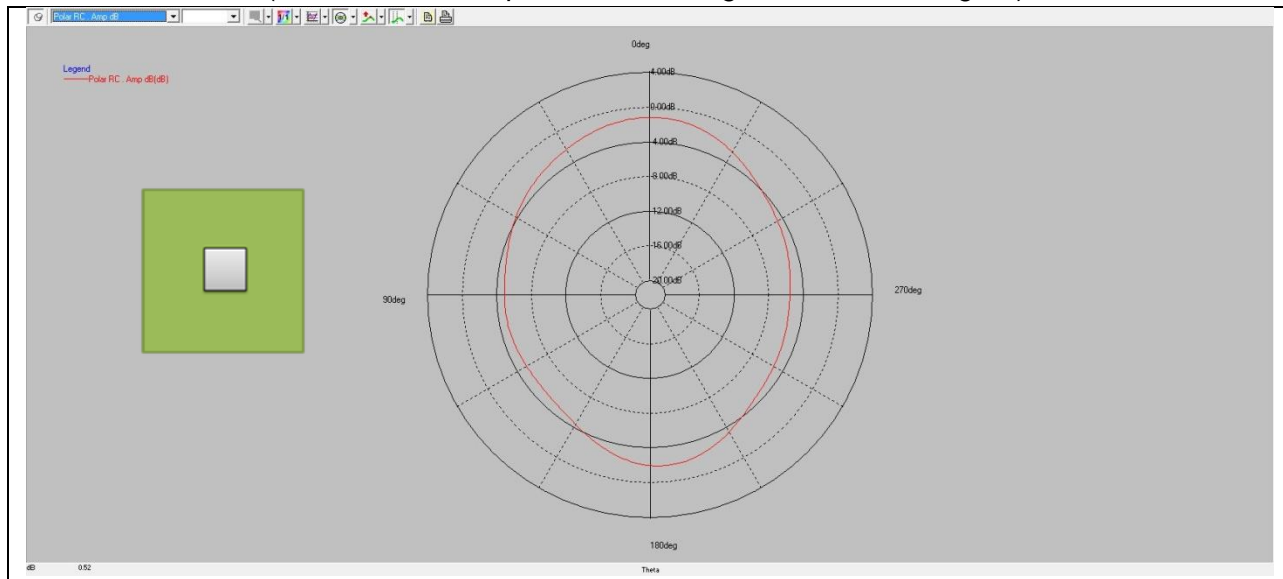

Issue: 1444

In the effort to improve our products, we reserve the right to make changes judged to be necessary.

CONFIDENTIAL AND PROPRIETARY INFORMATION

This document contains confidential and proprietary information of Pulse Electronics, Inc. (Pulse) and is protected by copyright, trade secret and other state and federal laws. Its receipt or possession does not convey any rights to reproduce, disclose its contents, or to manufacture, use or sell anything it may describe. Reproduction, disclosure or use without specific written authorization of Pulse is strictly forbidden.

FM50039 Rev 0, 5/2/2013



GNSS patch antenna

1.57542GHz / 1.598-1.606GHz

W3216

Series : **ANTENNA**

(Glonass Elevation plane RHCP gain)

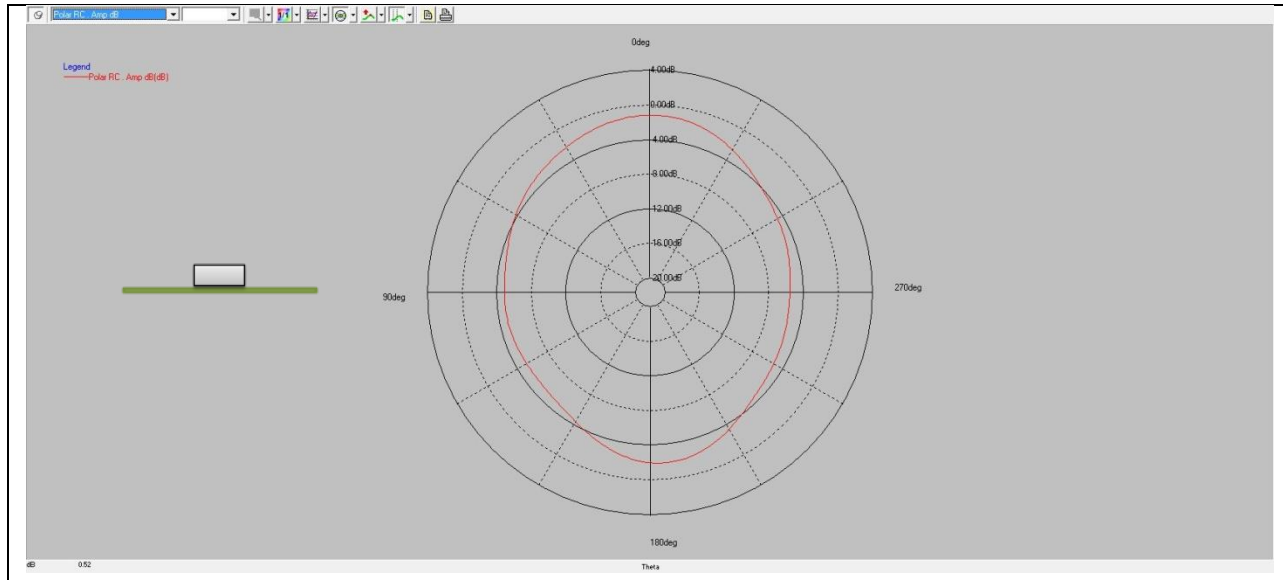

(Glonass Azimuth plane RHCP gain, conical 45degree)

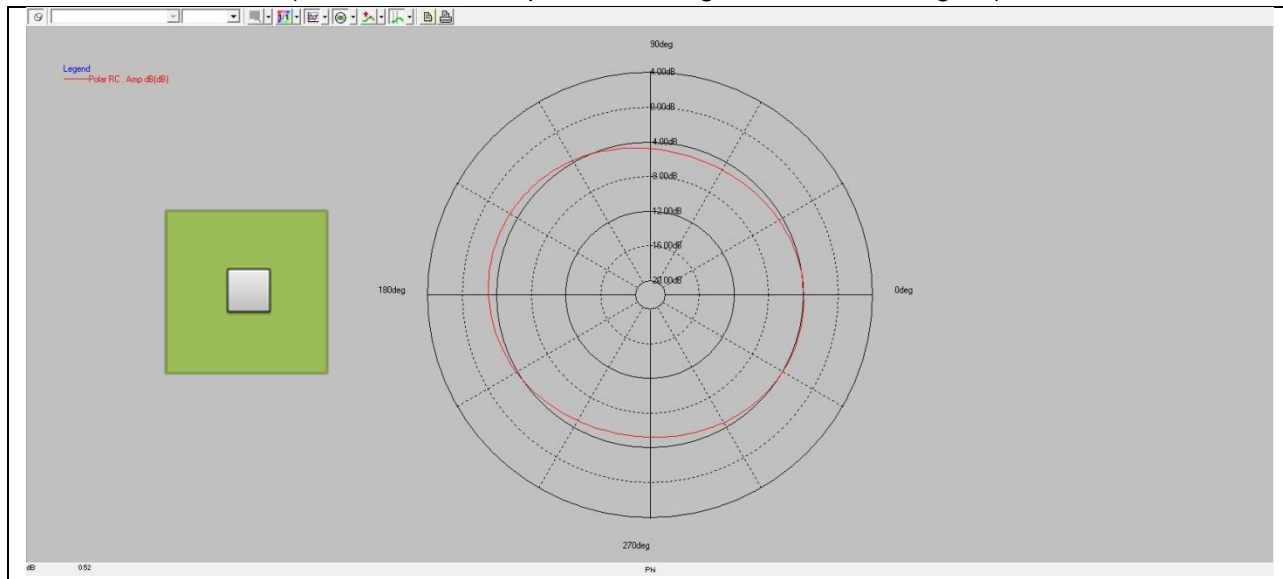

Issue: 1444

In the effort to improve our products, we reserve the right to make changes judged to be necessary.

CONFIDENTIAL AND PROPRIETARY INFORMATION

This document contains confidential and proprietary information of Pulse Electronics, Inc. (Pulse) and is protected by copyright, trade secret and other state and federal laws. Its receipt or possession does not convey any rights to reproduce, disclose its contents, or to manufacture, use or sell anything it may describe. Reproduction, disclosure or use without specific written authorization of Pulse is strictly forbidden.

FM50039 Rev 0, 5/2/2013

