

0RQB-C5U54x

Isolated DC-DC Converter

The 0RQB-C5U54x is an isolated DC-DC converter that operates from a nominal 24 VDC, 48 VDC source.

This unit will provide up to 162 W of output power from a nominal 24 VDC, 48 VDC input. This unit is designed to be highly efficient.

Features include over current protection, overvoltage protection and input under-voltage lockout.



Key Features & Benefits

- 24/48 VDC Input
- 54 VDC @ 3 A Output
- 1/4th Brick Converter
- Fixed Frequency
- High Efficiency
- Output Over-Voltage Protection
- Over Temperature Protection
- Input Over / Under Voltage Lockout
- Over Current and Short Circuit Protection
- Approved to UL/CSA/IEC60950-1, 2nd +A2 Version
- Class II, Category 2, Isolated DC-DC Converter (refer to IPC-9592B)

Applications

- Industrial
- Computers and Peripherals
- Telecommunications



bel POWER
SOLUTIONS &
PROTECTION

a bel group

belfuse.com/power-solutions

1. MODEL SELECTION

MODEL NUMBER	OUTPUT VOLTAGE	INPUT VOLTAGE	MAX. OUTPUT CURRENT	MAX. OUTPUT POWER	TYPICAL EFFICIENCY
0RQB-C5U54x	54 VDC	24/48 VDC	3 A	162 W	89%

NOTE: Add "G" suffix at the end of the model number to indicate Tray Packaging.

PART NUMBER EXPLANATION

0	R	QB	-	C5	U	54	x	G
Mounting Type	RoHS Status	Series Name		Output Power	Input Range	Output Voltage	Active Logic	Package Type
Through Hole Mount	RoHS	1/4th Brick		162 W	24/48 V	54 V	L- Active low, with base plate, 0- Active high, with base plate	G - Tray package

2. ABSOLUTE MAXIMUM RATINGS

PARAMETER	DESCRIPTION	MIN	TYP	MAX	UNITS
Input Voltage	Continuous Non-operating	-0.5	-	80	V
Remote On/Off		-0.3	-	15	V
Trim		0	-	5	V
Current Sink		0	-	10	mA
Isolation Voltage	Input to output	-	-	2250	VDC
Operating Temperature	Temperature measured at the center of the baseplate, full load	-40	-	90	°C
	Temperature measured at the center of the baseplate, half load	-40	-	95	°C
Thermal Resistance	Baseplate to heatsink, flat greased surface	-	0.24	-	°C /W
Storage Temperature		-55	-	125	°C
Altitude		-	-	2000	m

NOTE: Ratings used beyond the maximum ratings may cause a reliability degradation of the converter or may permanently damage the device.

3. INPUT SPECIFICATIONS

All specifications are typical at 25°C unless otherwise stated.

PARAMETER	DESCRIPTION	MIN	TYP	MAX	UNIT
Operating Input Voltage		18	-	75	V
Input Current		-	-	11	A
Input Current (no load)	Vin = 48 V, Ta = 25°C	-	100	150	mA
Input Reflected Ripple Current (rms)	With simulated source impedance of 12 μH, 5 Hz to 20 MHz. Use a 47 μF/100 V electrolytic capacitor with ESR =1 ohm max, at 25°C.	-	-	15	mA
Input Reflected Ripple Current (pk-pk)		-	-	50	mA
Under-Voltage Turn on Voltage Threshold	Turn on threshold	16	16.8	17.5	V
Under-Voltage Turn off Voltage Threshold	Lockout turn off, non-latching	14	15	15.5	V
Over-Voltage Shutdown Threshold	Auto-recovery and non-latching.	76.5	78	80.3	V
Over-Voltage Recovery Threshold		76	77	78	V
Input Fast-Acting Fuse	Recommended (on system board)	-	15	-	A

CAUTION: This converter is not internally fused. An input line fuse must be used in application.

4. OUTPUT SPECIFICATIONS

All specifications are typical at nominal input, full load at 25°C unless otherwise stated.

PARAMETER	DESCRIPTION	MIN	TYP	MAX	UNIT
Output Voltage Set Point	Test condition of the output set point: Vin=48V, Io=100% load at 25°C ambient.	53	54	55	V
Load Regulation		-	50	100	mV
Line Regulation		-	50	100	mV
Regulation Over Temperature		-	±200	±350	%/°C
Ripple and Noise (pk-pk)	40 KHz – 100 MHz BW, with 0.1 µF ceramic capacitor and 1000µF bulk electrolytic at output.	-	-	300	mV
Ripple and Noise (rms)		-	-	100	mV
Output Current Range		0	-	3	A
Output DC Current Limit	Enter a hiccup mode, non-latching.	3.45	4	4.6	A
Rise Time	Vin = 48 V, Io = 3 A, with 1000 µF bulk electrolytic at output.	-	0.5	1	s
Start-up Time (from Venable and Vin)		-	-	2	s
Overshoot at Turn on		-	0	3	%
Undershoot at Turn off		-	0	3	%
Output Capacitance		200	-	1000	µF
Transient Response					
ΔV 50%-75% of Max Load		-	-	3	%Vout
Settling Time	di/dt = 0.1 A/us, with 1000 µF bulk electrolytic at output.	-	-	2.5	ms
ΔV 75%-50% of Max Load		-	-	3	%Vout
Settling Time		-	-	2.5	ms

5. GENERAL SPECIFICATIONS

Notes: All specifications are typical at 25 °C unless otherwise stated.

PARAMETER	DESCRIPTION	MIN	TYP	MAX	UNIT
Efficiency	Io=60% Irate -100% Irate	87	89	-	%
	Io=40% Irate-60% Irate	85	87	-	%
Switching Frequency		-	200	-	kHz
Output Voltage Trim Range		50	-	56	V
Over Temperature Protection	Baseplate temperature.	-	120	-	°C
Over Voltage Protection(Static)	Enter a latching, non-hiccup mode	57.5	58	58.5	V
FIT	Calculated Per IEC 62380 TR 1 (UTEK 80-810) (Vin = 24 V, Vo = 54 V, Io = 3A, 0 LFM, Tac = 50°C, Tae = 35°C)	-	177.58	-	-
MTBF		-	5.63	-	Mhrs
Weight		-	68	-	g
Dimensions (L x W x H)			2.30 x 1.45 x 0.59		inch
			58.42 x 36.84 x 15		mm
Isolation Characteristics					
Input to Output		-	-	2250	V
Input to Heatsink		-	-	2250	V
Output to Heatsink		-	-	2250	V
Isolation Resistance		10M	-	-	Ohm
Isolation Capacitance		-	-	3900	pF



Asia-Pacific
+86 755 298 85888

Europe, Middle East
+353 61 225 977

North America
+1 408 785 5200

6. EFFICIENCY DATA

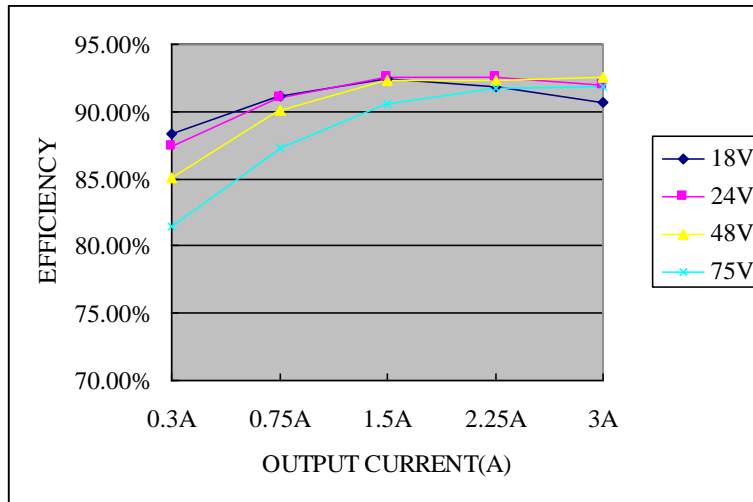

7. THERMAL DEARTING CURVES

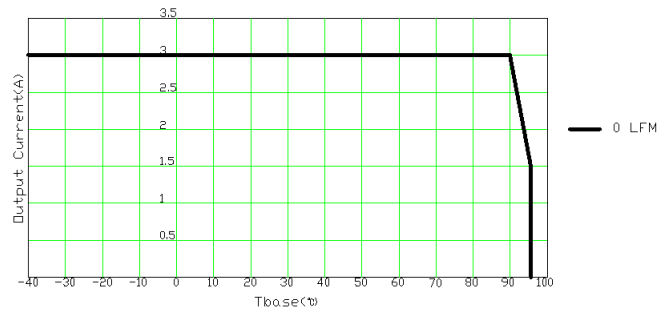
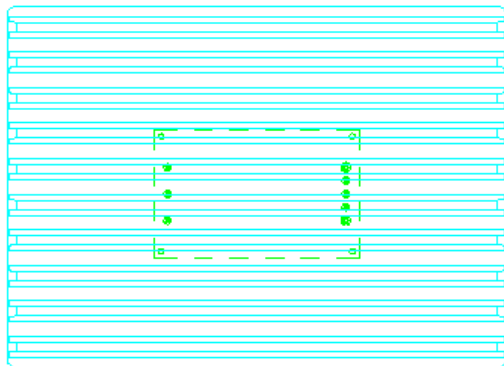

Vin Vout

HSK Dimension 142x110x16mm

8. REMOTE ON/OFF

PARAMETER		DESCRIPTION	MIN	TYP	MAX	UNIT
Signal Low (Unit On)	Active Low	Remote On/Off pin is open, the module is off.	-0.3	-	0.8	V
Signal High (Unit Off)			2.4	-	15	V
Signal Low (Unit Off)	Active High	Remote On/Off pin is open; the module is on.	-0.3	-	0.8	V
Signal High (Unit On)			2.4	-	15	V
Current Sink			0	-	1	mA

Recommended remote on/off circuit for active low

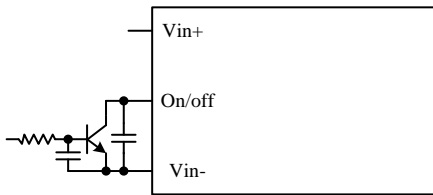

Control with open collector/drain circuit

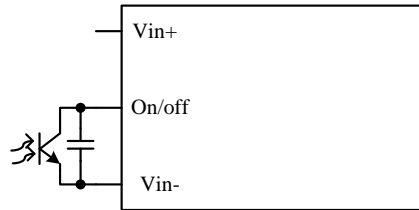

Control with photocoupler circuit

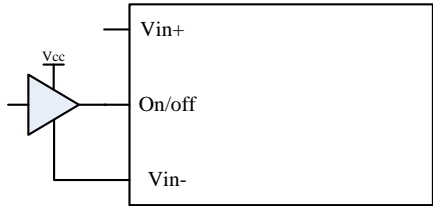

Control with logic circuit

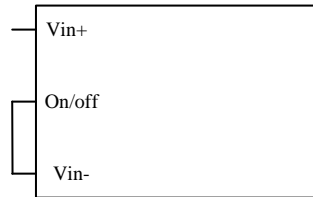

Permanently on

Recommended remote on/off circuit for active high

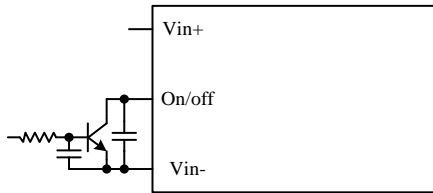

Control with open collector/drain circuit

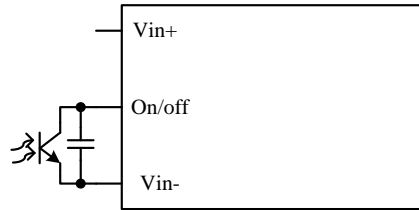

Control with photocoupler circuit

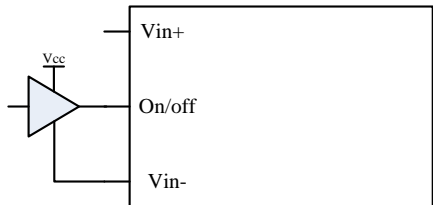

Control with logic circuit

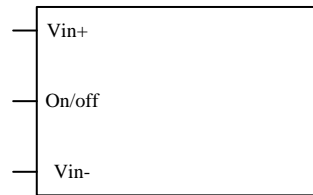

Permanently on

9. REMOTE SENSE

This module has remote sense compensation feature. It can minimize the effects of resistance between module's output and load in system layout and facilitates accurate voltage regulation at load terminals or other selected point.

The remote sense lines carries very little current and hence do not require a large cross-sectional area.

This module compensates for a maximum drop of 4% of the nominal output voltage.

If the unit is already trimmed up, the available remote sense compensation range should be correspondingly reduced. The total voltage increased by trim and remote sense should not exceed 4% of the nominal output voltage.

When using remote sense compensation, all the resistance, parasitic inductance and capacitance of the system are incorporated within the feedback loop of this module. The can make an effect on the module's compensation, affecting the stability and din.

Recommend the connection of remote sense compensation as below figure. There are a resistor RS+ (100 ohm) from Vo+ to Sense+ and a resistor RS- (100 ohm) from Vo- to Sense- inside of this module.

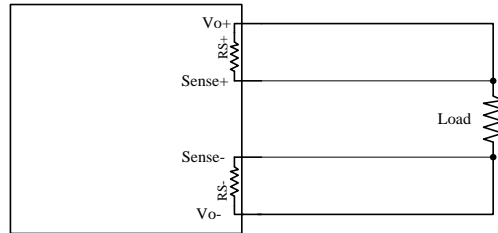

If not using remote sense compensation, please connect sense directly to output at module's pin, that is, connect sense+ to Vo+ and sense- to Vo- at module's pin, the shorter the better. see below figure.

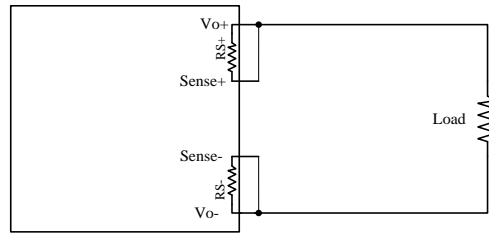

10. TRIM

Trim down test circuit

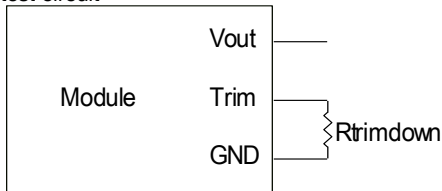

$$R_{trimdown} = \frac{Vo_{req}}{54 - Vo_{req}} - 1 [k\Omega]$$

Trim up test circuit

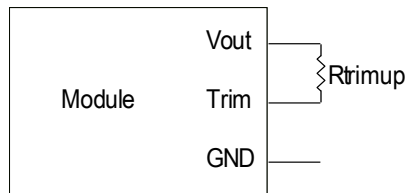

$$R_{trimup} = \frac{1 - 0.02296}{0.02296 - 1.24 / Vo_{req}} - 1 [k\Omega]$$

Note: Vo_req=Desired(trimmed) output voltage[V]

Safety:

CSA certificated to UL/IEC60950-1,2nd +A2 version
 CB certificated to IEC60950-1,2nd +A2 version

11. MECHANICAL DIMENSIONS

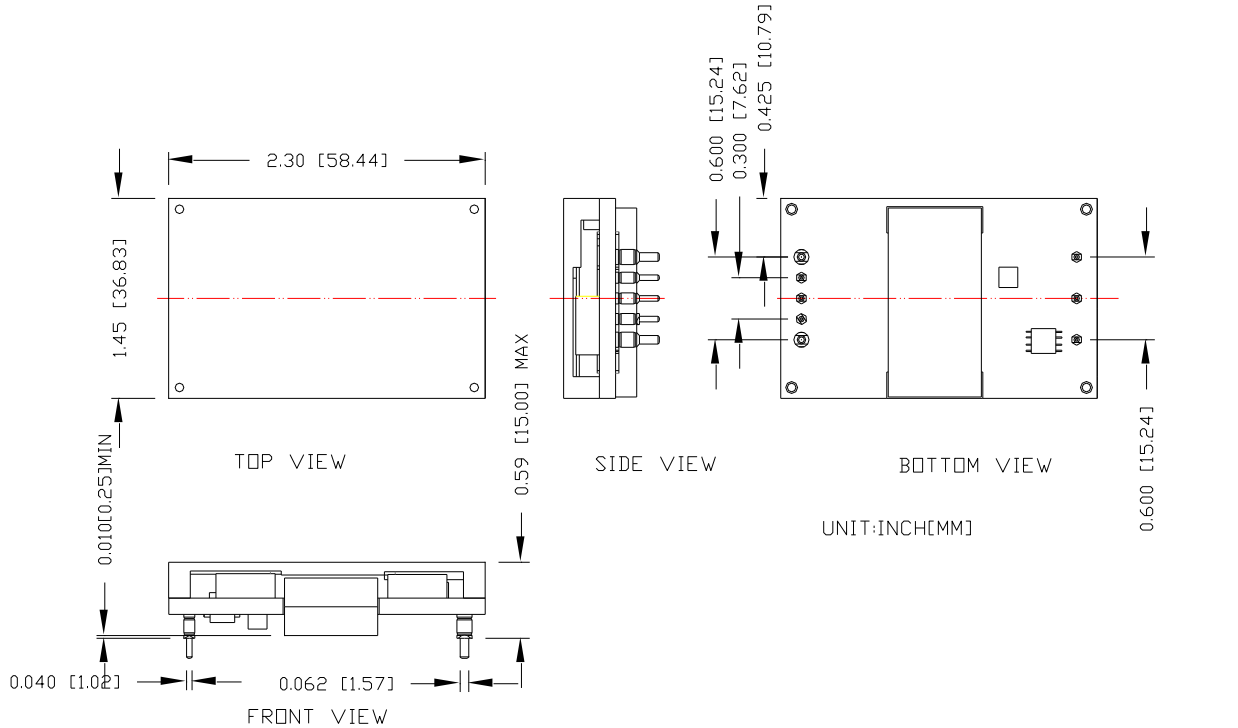

RECOMMENDED PAD LAYOUT

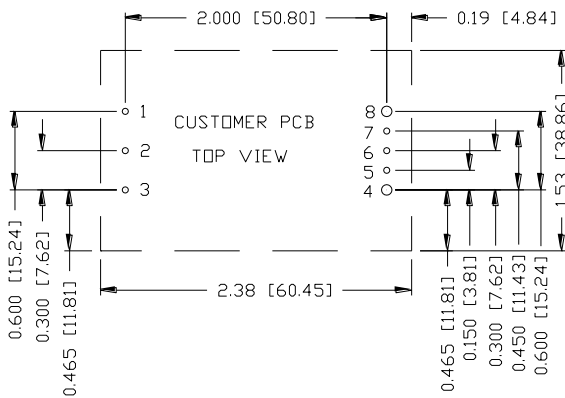

1,2,3,5,6,7 ϕ 0.047 HOLE SIZE, ϕ 0.08 min PAD SIZE
 4,8 ϕ 0.07 HOLE SIZE, ϕ 0.10 min PAD SIZE

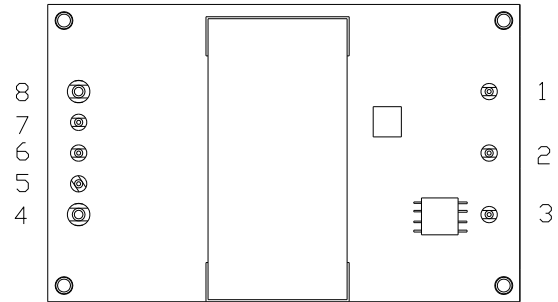

PIN CONNECTIONS

PIN	FUNCTION	PIN	FUNCTION
1	Vin (+)	5	Sense(-)
2	ON/OFF	6	Trim
3	Vin (-)	7	Sense(+)
4	Vout(-)	8	Vout(+)

Notes: This module is recommended and compatible with Pb-Free Wave Soldering and must be soldered using a peak solder temperature of no more than 260 °C for less than 5 seconds.

- 1) All Pins: Material - Copper Alloy;
Finish - Tin plated
- 2) Undimensioned components are shown for visual reference only.
- 3) All dimensions in inches; Tolerances: x.xx +/-0.02 in [0.51 mm]. x.xxx +/-0.010 in [0.25 mm].

REVISION HISTORY

DATE	REVISION	CHANGES DETAIL	APPROVAL
2013-5-13	A	First release	Summer Wang
2013-5-21	B	Update General	Jessica Yan
2013-6-25	C	Update General	Jessica Yan
2013-12-17	D	Update Abs Max, Output Specs, General, Efficiency Data, TD, MD	Jessica Yan
2014-2-13	E	Update TD	Jessica Yan
2014-2-26	F	Update Input Specs and TD	Jessica Yan
2014-2-28	G	Update TD	Jessica Yan
2014-9-3	H	Update Input and out specs	Jessica Yan
2014-12-24	I	Update MTBF and FIT	Jessica Yan
2015-2-10	J	Update MD, Description	Jessica Yan
2015-10-23	K	Update the maximum module height from 0.57" to 0.59".	Jessica Yan
2016-02-26	L	Update Absolute maximum rating	Jessica Yan
2016-04-21	M	Update Safety Certification, MTBF, Thermal Derating Curve.	Jessica Yan
2017-06-07	AN	Update the version.	HL Lu

For more information on these products consult: tech.support@psbel.com

NUCLEAR AND MEDICAL APPLICATIONS - Products are not designed or intended for use as critical components in life support systems, equipment used in hazardous environments, or nuclear control systems.

TECHNICAL REVISIONS - The appearance of products, including safety agency certifications pictured on labels, may change depending on the date manufactured. Specifications are subject to change without notice.



tech.support@psbel.com
belfuse.com/power-solutions