

The Zyklop Ratchets, 1/4"



EAN/GTIN:	4013288121103	Dimension:	215x170x50 mm
Part no.:	05003533001	Weight:	1512 g
Article no.:	8100 SA 2	Country of origin:	CZ
		Customs tariff number:	82041100

- Combines five different types of a ratchet in one
- Flywheel design and easy-to-grip free-turning sleeve for very high working speeds
- 42-piece set in a robust metal case
- Freely pivoting ratchet head
- "Take it easy" Tool Finder with colour coding according to sizes

42-piece Zyklop set in robust metal case: Zyklop ratchet with 1/4" drive. The 72 fine-pitched teeth enable a low return angle of only 5°. The ratchet head pivots freely and can be locked into any position by using the slide switch that is positioned on either side. It is even possible to work conveniently in very confined and difficult-to-access areas with enhanced hand clearance. The predefined locking positions at 0°, 15° and 90°, both to the right and left, ensure safe working without any slipping of the ratchet head. The ratchet can be used as a conventional screwdriver in the 0° position by attaching an adaptor and a bit. The flywheel design ensures rapid screwdriving. The rotation-symmetric construction of the Kraftform handle and the free-turning sleeve support rapid twisting. The outstanding design of the Kraftform handle fits perfectly into the hand preventing hand injuries such as blisters and calluses. The hard materials used for the handle ensure quick and easy hand repositioning without any danger of the skin "sticking" to the handle. The softer anti-slip zones enable the low-loss transfer of high torque. For 1/4" square sockets as well as 1/4" adaptors with square drive, equipped with ball lock. Including 13 Zyklop sockets, 2 Zyklop extensions with free-turning sleeve, 1 wobble extension, 1 T-handle, 1 universal joint, 1 adaptor with quick-release chuck, 22 bits. "Take it easy" Tool Finder with colour coding according to sizes.

Weblink

http://products.wera.de/en/tools_for_the_aerospace_segment_ratchets_the_zyklop_ratchets_1_4_8100_sa_2.html

Wera - 8100 SA 2
05003533001 - 4013288121103

Wera Werkzeuge GmbH
Korzter Straße 21-25
D-42349 Wuppertal
Tel: +49 (0)2 02 / 40 45-0
E-Mail: info@wera.de

The Zyklop Ratchets, 1/4"

Content:

 **8000 A**
05003500001 1 x 1/4"x152.0





 **8790 HMA**
05003501001 1 x 4.0x23.0
05003502001 1 x 4.5x23.0
05003503001 1 x 5.0x23.0
05003504001 1 x 5.5x23.0
05003505001 1 x 6.0x23.0
05003506001 1 x 7.0x23.0
05003507001 1 x 8.0x23.0
05003508001 1 x 9.0x23.0
05003509001 1 x 10.0x23.0
05003510001 1 x 11.0x23.0
05003511001 1 x 12.0x23.0
05003512001 1 x 13.0x23.0
05003513001 1 x 14.0x23.0





 **8789 A**
05003524001 1 x 1/4"x110.0





 **8794 A**
05003527001 1 x 1/4"x56.0





 **8795 A**
05003528001 1 x 1/4"x35.5





 **8784 A1**
05003529001 1 x 1/4"x37.0





 **8796 SA**
05003530001 1 x 1/4"x75.0





 **8796 LA**
05003531001 1 x 1/4"x150.0





 **851/1 Z PH**
05072070001 1 x PH 1x25
05072072001 1 x PH 2x25
05072074001 1 x PH 3x25



 **855/1 Z PZ**
05072080001 1 x PZ 1x25
05072082001 1 x PZ 2x25
05072084001 1 x PZ 3x25





 **867/1 Z TORX® B0**
05066498001 1 x TX 8x25
05066499001 1 x TX 9x25
05066500001 1 x TX 10x25
05066505001 1 x TX 15x25
05066510001 1 x TX 20x25
05066515001 1 x TX 25x25
05066525001 1 x TX 30x25
05066530001 1 x TX 40x25



 **840/1 Z Hex-Plus**
05056315001 1 x 3.0x25
05056320001 1 x 4.0x25
05056325001 1 x 5.0x25
05056330001 1 x 6.0x25
05056335001 1 x 8.0x25



 **800/1 Z**
05072055001 1 x 0.6x4.5x25
05072059001 1 x 1.0x5.5x25
05072063001 1 x 1.2x8.0x25



Weblink

http://products.wera.de/en/tools_for_the_aerospace_segment_ratchets_the_zyklop_ratchets_1_4_8100_sa_2.html

Wera - 8100 SA 2
05003533001 - 4013288121103

Wera Werkzeuge GmbH
Korzter Straße 21-25
D-42349 Wuppertal
Tel: +49 (0)2 02 / 40 45-0
E-Mail: info@wera.de

The Zyklop Ratchets, 1/4"

Zyklop "6 in 1"



Incredibly fast 1/4" Zyklop Speed ratchet with pivoting ratchet head and 5 predefined locking positions



1. Fine-tooth ratchet 2. Flex-head ratchet 3. Angle ratchet 4. Quick-release ratchet 5. Power ratchet 6. Screwdriver

Pivots freely



The ratchet head pivots freely and can be locked into any position by using the slide switch that is positioned on either side. It is even possible to work in very confined and difficult-to-access areas with enhanced hand clearance. The predefined locking at 0°, 15° and 90°, both to the right and left, ensure safe working without any slipping of the ratchet head.

Fast movers



The Zyklop Speed ratchets are really fast movers. The gyrating mass design means that screwdriving is accelerated. The rotation-symmetric structure of the Kraftform handle and the free-turning sleeve reinforce this rapid twisting process, particularly when the ratchet does not engage due to too little resistance in the thread.

Simple direction change



All Zyklop Speed ratchets feature a thumbwheel that can be used to quickly and easily switch between clockwise and anticlockwise rotation, at any position. No complicated handling, no loss of time!

Low return angle

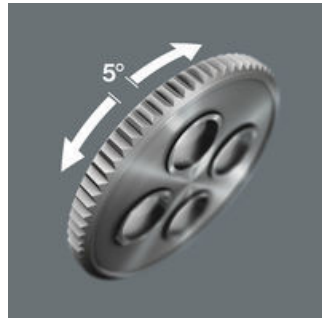

The reversible ratchet with 72 fine-pitched teeth has a low return angle of only 5°. This short stroke allows fast and precise work in all types of installation.

Screwdriver



The ratchet can be used as a conventional screwdriver in the 0° position by attaching a bitholding adaptor and a bit.

Two-tone foam insert



Perfectly conceived in every detail: the storage case for the Zyklop Speed ratchet sets! The two-tone foam insert section means that the tools can be quickly and reliably replaced, and that missing tools can be detected immediately. The tools and their position can be clearly seen in the lid where they have been laser-etched, ensuring that they are legible even when the insert section is covered with grease, dirt or oil. Additionally, the foam section can be removed and placed in the drawer of a tool cabinet or trolley.

Weblink

http://products.wera.de/en/tools_for_the_aerospace_segment_ratchets_the_zyklop_ratchets_1_4_8100_sa_2.html

Wera - 8100 SA 2
05003533001 - 4013288121103

Wera Werkzeuge GmbH
Korzter Straße 21-25
D-42349 Wuppertal
Tel: +49 (0)2 02 / 40 45-0
E-Mail: info@wera.de

8100 SA 2 Zyklop Speed ratchet set, 1/4" drive, metric, 42 pieces

The Zyklop Ratchets, 1/4"



Weblink

http://products.wera.de/en/tools_for_the_aerospace_segment_ratchets_the_zyklop_ratchets_1_4_8100_sa_2.html

Wera - 8100 SA 2

05003533001 - 4013288121103

Wera Werkzeuge GmbH

Korzerter Straße 21-25

D-42349 Wuppertal

Tel: +49 (0)2 02 / 40 45-0

E-Mail: info@wera.de