

GLAND PLATE



APPLICATION

Gland plates are used with a plinth base to provide cable management solutions while maintaining a NEMA 12 rating. PROLINE G2's unique Duro-Stand Gland Plate was designed to bear the weight of a person, making it easier to work on the enclosure when the gland plate is installed.

FEATURES

- Consists of a base mounting surface and adjustable foam-gasketed gland plates that permit cable entry
- Sturdy, adjustable gland plates designed to bear the weight of a person
- Number of plates varies with depth: 400 mm and 500 mm (3 plates); 600 mm (4 plates); 800 mm (6 plates); 1000 mm (8 plates)

SPECIFICATIONS

- Galvanized or painted versions
- Sealed to maintain NEMA Type 12 rating
- 14-gauge (1.75 mm) mild steel or galvanized
- Can be used with Plinth Base (100 mm or 200 mm), 100 mm Solid Plinth Base, Mobile Base or Transportation Base
- Can be used without a base if casters, levelers or frame feet are installed
- Can be rotated 180 degrees for front or rear cable entry
- Installation hardware included
- Includes additional foam gasketing which can be applied to reposition the gasketed opening towards the center of the cabinet or to create two independent access points

FINISH

- For painted versions:
- Polyester powder paint; RAL 7035 textured light grey standard
 - Custom colors available

ACCESSORIES

- Plinth Base
- Fully-Sealed Plinth Base
- Caster Kit
- Levelers
- Frame Feet

BULLETIN: P40

Standard Product

Catalog Number	Fits Frame Width x Depth (mm)	Finish	No. of Plates
P2BGP45	400 x 500	Painted	3
P2BGP45G	400 x 500	Plated	3
P2BGP46	400 x 600	Painted	4
P2BGP46G	400 x 600	Plated	4
P2BGP64	600 x 400	Painted	3
P2BGP64G	600 x 400	Plated	3
P2BGP65	600 x 500	Painted	3
P2BGP65G	600 x 500	Plated	3
P2BGP66	600 x 600	Painted	4
P2BGP66G	600 x 600	Plated	4
P2BGP68	600 x 800	Painted	6
P2BGP68G	600 x 800	Plated	6
P2BGP84	800 x 400	Painted	3
P2BGP84G	800 x 400	Plated	3
P2BGP85	800 x 500	Painted	3
P2BGP85G	800 x 500	Plated	3
P2BGP86	800 x 600	Painted	4
P2BGP86G	800 x 600	Plated	4
P2BGP88	800 x 800	Painted	6
P2BGP88G	800 x 800	Plated	6
P2BGP810	800 x 1000	Painted	8
P2BGP810G	800 x 1000	Plated	8
P2BGP104	1000 x 400	Painted	3
P2BGP104G	1000 x 400	Plated	3
P2BGP105	1000 x 500	Painted	3
P2BGP105G	1000 x 500	Plated	3
P2BGP106	1000 x 600	Painted	4
P2BGP108	1000 x 600	Painted	4
P2BGP106G	1000 x 600	Plated	4
P2BGP108G	1000 x 800	Plated	6
P2BGP124	1200 x 400	Painted	3
P2BGP124G	1200 x 400	Plated	3
P2BGP125	1200 x 500	Painted	3
P2BGP125G	1200 x 500	Plated	3
P2BGP126	1200 x 600	Painted	4
P2BGP126G	1200 x 600	Plated	4
P2BGP128	1200 x 800	Painted	6
P2BGP128G	1200 x 800	Plated	6
P2BGP164	1600 x 400	Painted	3
P2BGP164G	1600 x 400	Plated	3
P2BGP165	1600 x 500	Painted	3
P2BGP165G	1600 x 500	Plated	3
P2BGP166	1600 x 600	Painted	4
P2BGP166G	1600 x 600	Plated	4
P2BGP168	1600 x 800	Painted	6
P2BGP168G	1600 x 800	Plated	6
P2BGP185	1800 x 500	Painted	3
P2BGP185G	1800 x 500	Plated	3
P2BGP186	1800 x 600	Painted	4
P2BGP186G	1800 x 600	Plated	4
P2BGP188	1800 x 800	Painted	6
P2BGP188G	1800 x 800	Plated	6

Model	Component	Type	Width	Depth	Specialty	Catalog Number
P2	B	GP	8	6	G	= P2BGP86G
PROLINE G2	Base	0 = solid base 0mm 1 = fully-sealed plinth P1 = plinth base 100mm P2 = plinth base 200mm GP = gland plate T = transportation base M = mobile base	mm 18 = 1800 16 = 1600 14 = 1400 12 = 1200 10 = 1000 8 = 800 6 = 600 4 = 400	mm 10 = 1000 8 = 800 6 = 600 5 = 500 4 = 400	Blank = standard HF = EMC protected G = Galvanized steel	

NOTE: Not every combination is available as a standard product.

0-MM SOLID BASE

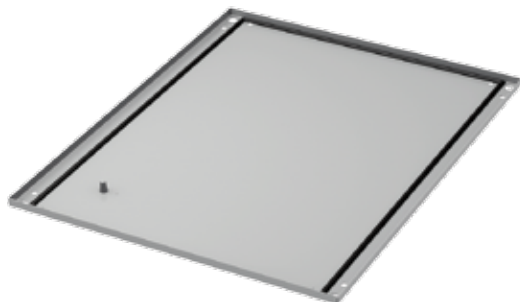

SPECIFICATIONS

- 16-gauge (1.5 mm) steel
- Includes four M12 hex bolts for installation

FINISH

- Polyester powder paint; RAL 7035 textured light gray standard
- Custom colors available

ACCESSORIES

- Caster Kit
- Levelers
- Frame Feet
- Frame Floor-Mounting Bracket

BULLETIN: P40

APPLICATION

PROLINE G2 0-mm Solid Bases are used to close the bottom opening on an enclosure frame.

FEATURES

- Casters or levelers can be used to attach the solid base, in place of the included hardware
- Seamless polyurethane gasket (UL component recognized) provides a water-tight, dust-tight seal against moisture and contaminants

Standard Product

Catalog Number	W (mm)	W (in.)	D (mm)	D (in.)	Fits Frame WxD (mm)
P2B045	390	15.4	460	18.1	400X500
P2B046	390	15.4	560	22.0	400X600
P2B064	590	23.2	360	14.2	600X400
P2B065	590	23.2	460	18.1	600X500
P2B066	590	23.2	560	22.0	600X600
P2B068	590	23.2	760	29.9	600X800
P2B084	790	31.1	360	14.2	800X400
P2B085	790	31.1	460	18.1	800X500
P2B086	790	31.1	560	22.0	800X600
P2B088	790	31.1	760	29.9	800X800
P2B0810	790	31.1	960	37.8	800X1000
P2B0104	990	39.0	360	14.2	1000X400
P2B0105	990	39.0	460	18.1	1000X500
P2B0108	990	39.0	760	29.9	1000X800
P2B0106	990	39.0	560	22.0	1000X600
P2B0124	1190	46.9	360	14.2	1200X400
P2B0125	1190	46.9	460	18.1	1200X500
P2B0126	1190	46.9	560	22.0	1200X600
P2B0128	1190	46.9	760	29.9	1200X800
P2B0164	1590	62.6	360	14.2	1600X400
P2B0165	1590	62.6	460	18.1	1600X500
P2B0166	1590	62.6	560	22.0	1600X600
P2B0168	1590	62.6	760	29.9	1600X800
P2B0185	1790	70.5	460	18.1	1800X500
P2B0186	1790	70.5	560	22.0	1800X600
P2B0188	1790	70.5	760	29.9	1800X800

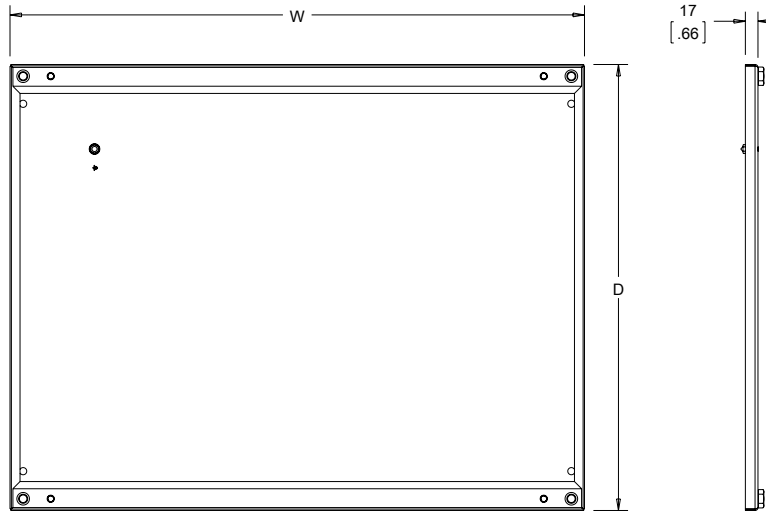

89129490

Model	Component	Type	Width	Depth	Specialty	Catalog Number
P2	B	0	8	6	Blank	= P2B086
PROLINE G2	Base	0 = solid base 0mm 1 = fully-sealed plinth P1 = plinth base 100mm P2 = plinth base 200mm GP = gland plate T = transportation base M = mobile base	mm 18 = 1800 16 = 1600 14 = 1400 12 = 1200 10 = 1000 8 = 800 6 = 600 4 = 400	mm 10 = 1000 8 = 800 6 = 600 5 = 500 4 = 400	Blank = standard HF = EMC protected G = Galvanized steel	

NOTE: Not every combination is available as a standard product.

PLINTH BASE



APPLICATION

PROLINE G2 Plinth Bases install under an enclosure to provide space for cables to enter from below.

FEATURES

- Four access panels for cable management options at the base of the enclosure
- Sturdy cast aluminum corner supports for superior performance under load
- Corner blocks can be installed onto the base of the frame independent of the cover plates, enabling the cover plates to be attached after integration and just prior to shipment.

SPECIFICATIONS

- Stackable up to 400mm in height using Plinth Base Stacking Kit (not included)
- 100 mm or 200 mm options
- To maintain a NEMA Type 12 environmental rating, gland plate must also be used in the base of the enclosure
- Installation hardware included
- Cover plates are 16-gauge (1.5 mm) steel

FINISH

- Polyester powder paint; RAL 9005 textured black standard
- Custom colors available

ACCESSORIES

- Gland Plate
- Plinth Base Stacking Kit

BULLETIN: P40

Standard Product **100 mm, For Frame Width Less Than 1200 mm**

Catalog Number	W (mm)	W (in.)	D (mm)	D (in.)	Fits Frame Width x Depth mm
P2BP145	399	15.71	464	18.27	400 x 500
P2BP146	399	15.71	564	22.21	400 x 600
P2BP164	599	23.58	364	14.33	600 x 400
P2BP165	599	23.58	464	18.27	600 x 500
P2BP166	599	23.58	564	22.21	600 x 600
P2BP168	599	23.58	764	30.08	600 x 800
P2BP184	799	31.46	364	14.33	800 x 400
P2BP185	799	31.46	464	18.27	800 x 500
P2BP186	799	31.46	564	22.21	800 x 600
P2BP188	799	31.46	764	30.08	800 x 800
P2BP1810	799	31.46	964	37.95	800 x 1000
P2BP1104	999	39.33	364	14.33	1000 x 400
P2BP1105	999	39.33	464	18.27	1000 x 500
P2BP1106	999	39.33	564	22.21	1000 x 600
P2BP1108	999	39.33	764	30.08	1000 x 800

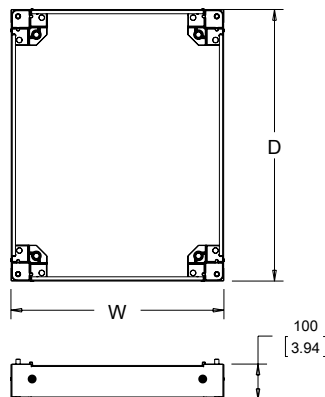

89129493

Standard Product 100 mm, For Frame Width 1200 mm and Greater

Catalog Number	W (mm)	W (in.)	D (mm)	D (in.)	Fits Frame Width x Depth mm
P2BP1124	1199	47.21	364	14.33	1200 x 400
P2BP1125	1199	47.21	464	18.27	1200 x 500
P2BP1126	1199	47.21	564	22.21	1200 x 600
P2BP1128	1199	47.21	764	30.07	1200 x 800
P2BP1164	1599	62.95	364	14.33	1600 x 400
P2BP1165	1599	62.95	464	18.27	1600 x 500
P2BP1166	1599	62.95	564	22.21	1600 x 600
P2BP1168	1599	62.95	764	30.07	1600 x 800
P2BP1185	1799	70.83	464	18.27	1800 x 500
P2BP1184	1799	70.83	364	14.33	1800 x 400
P2BP1186	1799	70.83	564	22.21	1800 x 600
P2BP1188	1799	70.83	764	30.07	1800 x 800

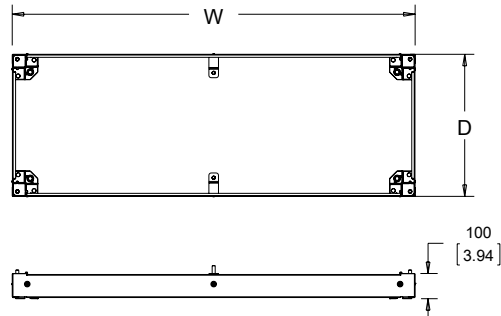

89131514

Standard Product 200 mm, For Frame Width Less Than 1200 mm

Catalog Number	W (mm)	W (in.)	D (mm)	D (in.)	Fits Frame Width x Depth mm
P2BP245	399	15.71	464	18.27	400 x 500
P2BP246	399	15.71	564	22.21	400 x 600
P2BP264	599	23.58	364	14.33	600 x 400
P2BP265	599	23.58	464	18.27	600 x 500
P2BP266	599	23.58	564	22.21	600 x 600
P2BP284	799	31.46	364	14.33	800 x 400
P2BP268	599	23.58	764	30.07	600x800
P2BP285	799	31.46	464	18.27	800 x 500
P2BP286	799	31.46	564	22.21	800 x 600
P2BP288	799	31.46	764	30.07	800 x 800
P2BP2810	999	39.33	964	37.95	800 x 1000
P2BP2104	999	39.33	364	14.33	1000 x 400
P2BP2105	999	39.33	464	18.27	1000 x 500
P2BP2106	999	39.33	564	22.21	1000 x 600
P2BP2108	999	39.33	764	30.07	1000 x 800

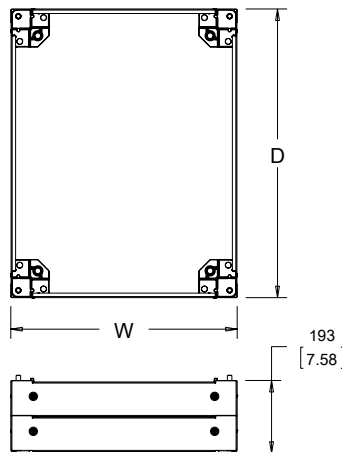

89129494

Standard Product 200 mm, For Frame Width 1200 mm and Greater

Catalog Number	W (mm)	W (in.)	D (mm)	D (in.)	Fits Frame Width x Depth mm
P2BP2124	1199	47.21	364	14.33	1200 x 400
P2BP2125	1199	47.21	464	18.27	1200 x 500
P2BP2126	1199	47.21	564	22.21	1200 x 600
P2BP2128	1199	47.21	764	31.08	1200 x 800
P2BP2164	1599	62.95	364	14.33	1600 x 400
P2BP2165	1599	62.95	464	18.27	1600 x 500
P2BP2166	1599	62.95	564	22.21	1600 x 600
P2BP2168	1599	62.95	764	31.08	1600 x 800
P2BP2185	1799	70.83	464	18.27	1800 x 500
P2BP2184	1799	70.83	364	14.33	1800 x 400
P2BP2186	1799	70.83	564	22.21	1800 x 600
P2BP2188	1799	70.83	764	31.08	1800 x 800

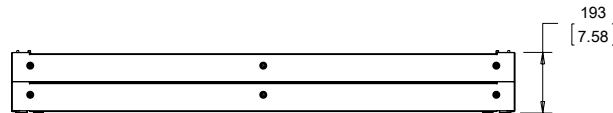
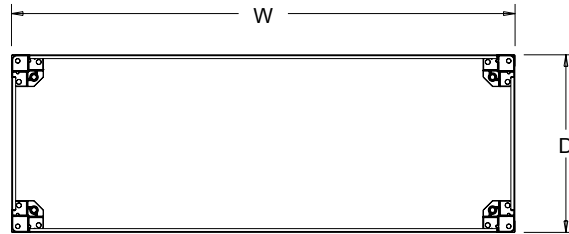

89131515

Model	Component	Type	Width	Depth	Specialty	Catalog Number
P2	B	P1	8	6	Blank	= P2BP186
PROLINE G2	Base	0 = solid base 0mm 1 = fully-sealed plinth P1 = plinth base 100mm P2 = plinth base 200mm P1D= plinth base 100mm disconnect GP = gland plate T = transportation base M = mobile base	mm 18 = 1800 16 = 1600 14 = 1400 12 = 1200 10 = 1000 8 = 800 6 = 600 4 = 400	mm 10 = 1000 8 = 800 6 = 600 5 = 500 4 = 400	Blank = standard HF = EMC protected G = Galvanized steel (gland plate only)	NOTE: Not every combination is available as a standard product.

PLINTH BASE STACKING KIT



The Plinth Base Stacking Kit is used to stack plinth bases up to 400 mm high. Kit consists of eight bolts and nuts and eight each of two types of washers.

BULLETIN: P20

Standard Product

Catalog Number	Description
PPBSK	Plinth Base Stacking Kit

FULLY-SEALED PLINTH BASE



APPLICATION

No need to use a gland plate in the base of the enclosure with the Fully-Sealed Plinth Base (100mm Solid Base), which includes fully-sealed gland plates on the sides. Solid bases can easily be joined, for convenient cable management in joined/ganged enclosures while maintaining Type 12 environmental rating.

FEATURES

- Maintains NEMA 12 rating without requiring gland plate
- Two side gland plates for cable management options
- Seamless polyurethane gasket (UL component recognized) provides a watertight, dust-tight seal against moisture and contaminants

SPECIFICATIONS

- Optional Cable Entry Gland Plate for additional cable management solutions
- Widths greater than 800 mm are 14 gauge (1.75 mm); widths of 800 mm or less are 16 gauge (1.5 mm) steel
- Welded corners
- Drill points for locating casters (not included)
- Installation hardware included

FINISH

- Polyester powder paint; RAL 9005 textured black standard
- Custom colors available

ACCESSORIES

- Cable Entry Gland Plate
- Gland Plate
- Fully-Sealed Plinth Base Joining Kit

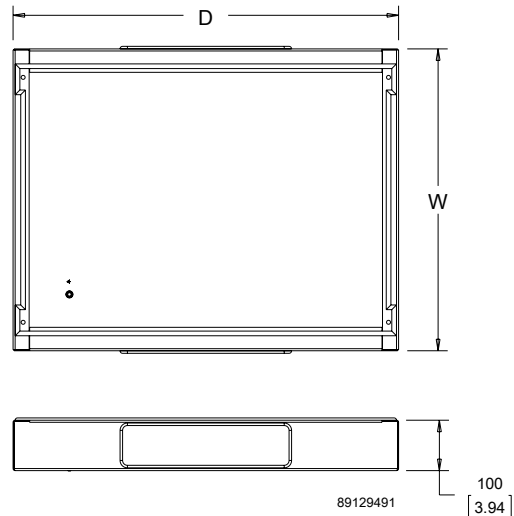

BULLETIN: P40

Catalog Number	W (mm)	W (in.)	D (mm)	D (in.)
P2B145	465	18.3	399	15.7
P2B146	565	22.2	399	15.7
P2B144	365	14.4	599	23.6
P2B165	465	18.3	599	23.6
P2B166	565	22.2	599	23.6
P2B168	765	30.1	599	23.6
P2B184	365	14.4	799	31.5
P2B185	465	18.3	799	31.5
P2B186	565	22.2	799	31.5
P2B188	765	30.1	799	31.5
P2B1810	965	38.0	799	31.5
P2B1104	365	14.4	999	39.3
P2B1105	465	18.3	999	39.3
P2B1106	565	22.2	999	39.3
P2B1108	765	30.1	999	39.9
P2B1124	365	14.4	1199	47.2
P2B1125	465	18.3	1199	47.2
P2B1126	565	22.2	1199	47.2
P2B1128	765	30.1	1199	47.2
P2B1164	365	14.4	1599	63.0
P2B1165	465	18.3	1599	63.0
P2B1166	565	22.2	1599	63.0
P2B1168	765	30.1	1599	63.0
P2B1184	365	14.4	1799	70.8
P2B1185	465	18.3	1799	70.8
P2B1186	565	22.2	1799	70.8
P2B1188	765	30.1	1799	70.8

Model	Component	Type	Width	Depth	Specialty	Catalog Number
P2	B	1	8	6	Blank	= P2B186
PROLINE G2	Base	0 = solid base 0mm 1 = fully-sealed plinth P1 = plinth base 100mm P2 = plinth base 200mm GP = gland plate T = transportation base M = mobile base	mm 18 = 1800 16 = 1600 14 = 1400 12 = 1200 10 = 1000 8 = 800 6 = 600 4 = 400	mm 10 = 1000 8 = 800 6 = 600 5 = 500 4 = 400	Blank = standard HF = EMC protected	

NOTE: Not every combination is available as a standard product.

CABLE ENTRY GLAND PLATE

APPLICATION

Cable Entry Gland Plates can be used instead of the solid gland plates on the Fully Sealed Plinth Base (100mm Solid Base) to provide additional cable management solutions.

SPECIFICATIONS

- Can be used in place of solid gland plates in Fully Sealed Plinth Base (100mm Solid Base)
- Adjustable opening
- Foam lined to maintain a dust-tight seal
- 14 gauge (1.75) mild steel

FINISH

- Polyester powder paint; RAL 9005 textured black standard
- Custom colors available

BULLETIN: P40

Catalog Number	Kit Qty.
P2ACEGP	1

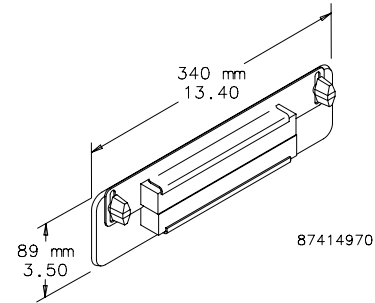

FULLY-SEALED PLINTH BASE JOINING KIT



APPLICATION

The Fully-Sealed Plinth Base Joining Kit provides a seal between the side gland plate openings on adjacent Fully-Sealed Plinth Bases in joined bay configurations. Used in combination with the PROLINE G2 side-to-side joining kit.

FEATURES

- Maintains NEMA 12 rating between Fully-Sealed Plinth bases
- Allows for sealed cable routing between joined cabinets

SPECIFICATIONS

- Includes nylon wire edge protector to prevent wear and abrasion of wires and cables
- Gasket and installation hardware included

BULLETIN: P40

Catalog Number	Description
P2AJSB	Joining Kit, Sealed Plinth Base

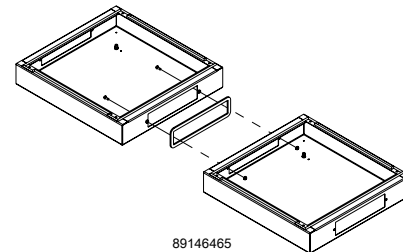

TRANSPORTATION BASE

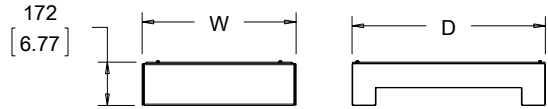
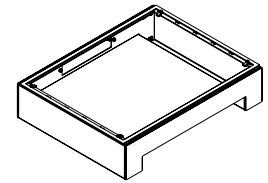

89129496

APPLICATION

PROLINE G2 Transportation Bases provide enhanced stability and forklift provisions for modular enclosures up to a maximum of 3000 mm (118.11) total width in a multiple-bay system.

FEATURES

- Can be used across bayed enclosures up to a maximum of 300mm (118.11in.) total width
- Maintains NEMA 12 rating without requiring gland plate
- Removable side cover plates allows wire access between bases

SPECIFICATIONS

- 10 gauge (3 mm), mild steel
- Can be configured in a variety of combinations
- Unique design allows forklift access from each end
- Gasket and installation hardware included

FINISH

- Polyester powder paint; RAL 9005 textured black standard
- Custom colors available

ACCESSORIES

Transportation Base Joining Kit, Side-to-Side

BULLETIN: P40

Standard Product

Catalog Number	W (mm)	W (in.)	D (mm)	D (in.)	Fits Frame WxD (mm)
P2BT45	411	16.2	467	18.4	400 x 500
P2BT46	411	16.2	567	22.3	400 x 600
P2BT64	611	24.1	367	14.4	600 x 400
P2BT65	611	24.1	467	18.4	600 x 500
P2BT66	611	24.1	567	22.3	600 x 600
P2BT68	611	24.1	767	30.2	600 x 800
P2BT84	811	31.9	367	14.4	800 x 400
P2BT85	811	31.9	467	18.4	800 x 500
P2BT86	811	31.9	567	22.3	800 x 600
P2BT88	811	31.9	767	30.2	800 x 800
P2BT810	811	31.9	967	38.1	800 x 1000
P2BT104	1011	39.8	367	14.4	1000 x 400
P2BT105	1011	39.8	467	18.4	1000 x 500
P2BT106	1011	39.8	567	22.3	1000 x 600
P2BT108	1011	39.8	767	30.2	1000 x 800
P2BT124	1216	47.9	367	14.4	1200 x 400
P2BT125	1216	47.9	467	18.4	1200 x 500
P2BT126	1216	47.9	567	22.3	1200 x 600
P2BT128	1216	47.9	767	30.2	1200 x 800
P2BT164	1616	63.6	367	14.4	1600 x 400
P2BT165	1616	63.6	467	18.4	1600 x 500
P2BT166	1616	63.6	567	22.3	1600 x 600
P2BT168	1616	63.6	767	30.2	1600 x 800
P2BT185	1816	71.5	467	18.4	1800 x 500
P2BT186	1816	71.5	567	22.3	1800 x 600
P2BT188	1816	71.5	767	30.2	1800 x 800

Model	Component	Type	Width	Depth	Catalog Number
P2	B	T	8	6	P2BT86
PROLINE G2	Base	T = transportation base	mm	mm	
			18 = 1800 16 = 1600 12 = 1200 10 = 1000 8 = 800 6 = 600 4 = 400	10 = 1000 8 = 800 6 = 600 5 = 500 4 = 400	

NOTE: Not every combination is available as a standard product.

TRANSPORTATION BASE JOINING KIT, SIDE-TO-SIDE



APPLICATION

The PROLINE G2 Transportation Base Joining Kit, Side-to-Side interconnects transportation bases while maintaining the NEMA Type 12 rating.

FEATURES

- Maintains NEMA 12 rating between Fully-Sealed Plinth bases
- Allows for sealed cable routing between joined cabinets

SPECIFICATIONS

- Gasket and installation hardware included
- Furnished grommet applied to edge of wire feed

BULLETIN: P40

Catalog Number	Description
P2AJT	Transportation Base Joining Kit, Side-to-Side

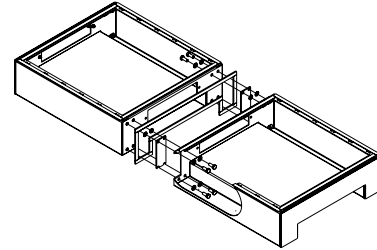

89146440

TRANSFORMER RAILS



APPLICATION

Transformer Rails are used to mount heavy components and transformers in the bottom of an enclosure.

FEATURES

- Installed side-to-side in the frame for component mounting
- Includes four M10 clamping nuts and bolts to attach equipment to rails

SPECIFICATIONS

- Rails slotted to fit the integral mounting holes in the frame
- All mounting hardware included

FINISH

Plated

BULLETIN: P20

Catalog Number	Length (mm)	Length (in.)	Fits Frame Width (mm)
PTR6	534	21.02	600
PTR8	734	28.90	800
PTR12	1134	44.65	1200

MOBILE BASE



APPLICATION

Mobile bases include casters and extend beyond the front and rear of 600- and 800-mm wide modular enclosures to provide enhanced stability.

FEATURES

- The front and rear top surfaces of the base are trimmed with 3-mm thick black rubber mats
- Four non-locking casters provide a maximum load-bearing capacity of 1000 lb. (453.6 kg)

SPECIFICATIONS

- Available as standard product for 600- and 800-mm wide frames
- The base fastens to the underside of the frame and provides integral mounting of furnished casters
- Casters and mounting hardware are furnished
- Exercise care when using casters to move the enclosure
- Avoid tipping and damage to the enclosure and its contents by slowly moving the enclosure on its casters across smooth, flat flooring
- Avoid large cracks, floor displacement, seams, gravel and any other obstruction
- Never use casters while transporting an enclosure by truck on roadways
- Contact Hoffman for more information

FINISH

- Polyester powder paint; RAL 9005 textured black standard
- Custom colors available

ACCESSORIES

Mobile Base Leveling Kit

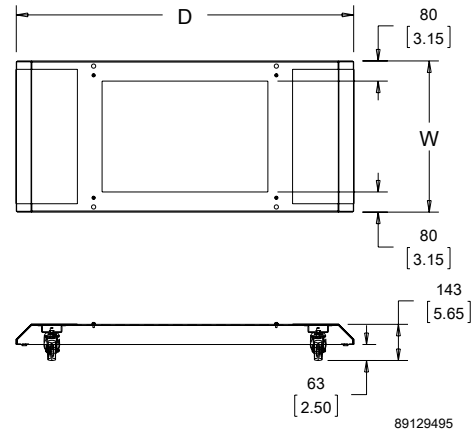

BULLETIN: P40

Standard Product

Catalog Number	W (mm)	W (in.)	D (mm)	D (in.)	Fits Frame WxD (mm)
P2BM64	600	23.6	939	37.0	600 x 400
P2BM65	600	23.6	1039	40.9	600 x 500
P2BM66	600	23.6	1139	44.8	600 x 600
P2BM68	600	23.6	1339	52.7	600 x 800
P2BM84	800	31.5	939	37.0	800 x 400
P2BM85	800	31.5	1039	40.9	800 x 500
P2BM86	800	31.5	1139	44.8	800 x 600
P2BM88	800	31.5	1339	52.7	800 x 800
P2BM810	800	31.5	1539	60.6	800 x 1000

Model	Component	Type	Width	Depth	Catalog Number
P2	B	M	8	6	= P2BM86
PROLINE G2	Base	<ul style="list-style-type: none"> 0 = solid base 0mm 1 = fully sealed plinth P1 = plinth base 100mm P2 = plinth base 200mm GP = gland plate T = transportation base M = mobile base 	<ul style="list-style-type: none"> mm 8 = 800 6 = 600 	<ul style="list-style-type: none"> mm 10 = 1000 8 = 800 6 = 600 5 = 500 4 = 400 	

NOTE: Not every combination is available as a standard product.

LEVELER KITS



The Post-type Leveler Kit allows for height adjustment at the enclosure corners to account for uneven floors. Levelers thread into the frame corners, and can be used with a bottom-mounted Gland Plate or a 0-mm Solid Base; they may also be affixed to the corner blocks of the standard Plinth Base. Levelers are plated for indoor use, and are rated to 3000lbs (1361kg).

FRAME FEET



Four die-cast feet for use on the bottom of PROLINE frames that raise the frame 9 mm.

BULLETIN: P20

CASTER KIT



The Plate Caster Kit consists of four polyamide casters (two locking and two non-locking) secured to formed-steel plates painted RAL 7035. The Plate Caster hardware secures the caster at the frame corners, and can be used with a bottom-mounted Gland Plate or a 0-mm Solid Base; however, they do not work with Plinth Bases. Plate Casters can also be used on joined PROLINE G2 enclosures,

STAINLESS STEEL LEGS



Legs mount to the bottom of a solid base to elevate the enclosure 4 in. (100 mm) from the floor. The legs are made of Type 304 stainless steel and are appropriate for hose-down applications. Mounting hardware is included.

The Mobile Base Leveling Kit allows for height adjustments at the corners of the Mobile Base to account for uneven floors. Levelers are plated for indoor use, and are rated to 3000 lbs. (1361 kg). **Note: the non-locking casters of the Mobile Base have a load bearing capacity of 1000 lbs. (453.6 kg); exercise caution if disengaging the levelers.**

BULLETIN: P40

Catalog Number	Description
P2ALK	Post-type Leveler Kit
P2ALKMB	Mobile Base Leveling Kit

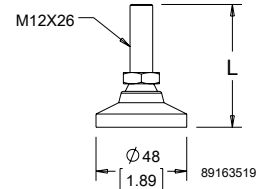

Catalog Number	Description
PFFM1Z	Frame Feet

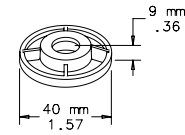

with no caster swivel interference. Casters are rated to 3000 lbs. (1361 kg).

Exercise caution when moving enclosures with casters: avoid adverse floor conditions such as cracks, seams, displacement, etc. Never use casters while transporting an enclosure by truck on roadways.

BULLETIN: P40

Catalog Number	Description
P2ACK	Plate Caster Kit

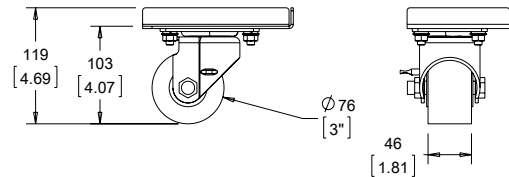

NOTE: These legs will not fit on the PROLINE G2 Fully-Sealed Plinth Base.

BULLETIN: P20S

Catalog Number	Description
PLEGSS	(4) Stainless Steel Legs

