

TFT DISPLAY MODULE

Product Specification

Customer	Standard		 <p>UReady™ 28000</p>
Product Number	DMT080YYNLCMU-1A		
Customer Part Number	UReady-28000T		
Customer Approval		Date:	

Internal Approvals

Product Mgr	Doc. Control	Electr. Eng
Luo Luo	Luo Luo	Eric Wan
Date: 28/09/17	Date: 28/09/17	Date: 28/09/17



Revision Record

Rev.	Date	Page	Chapt.	Comment	ECR no.
1.0	28-Sept-17	All	All	Initial Release	
2.0	05-Mar-18	6/7	2.1/2.2	Update thickness/drawing	
3.0	19-Mar-18	1	All	Add UReady logo/UReady part number and update spec template	



Table of Contents

1.0	MAIN FEATURES	5
2.0	MECHANICAL SPECIFICATION	6
2.1	Mechanical Characteristics	6
2.2	Mechanical Drawing	7
3.0	ELECTRICAL SPECIFICATION	8
3.1	Absolute Maximum Ratings	8
3.1.1	TFT	8
3.1.2	PCT	8
3.2	Electrical Characteristics	9
3.2.1	TFT	9
3.2.2	PCT	10
3.3	Interface Pin Assignment	11
3.3.1	LCM Pin Assignment	11
3.3.2	PCT PIN ASSIGNMENT	13
3.4	Timing Characteristics	14
3.4.1	Timing Parameters(Sync mode)	14
3.4.2	LVDS Rx Interface Timing Parameter	15
3.4.3	Input Signals,Basic Display Colors & Gray Scale Of Colors	16
3.4.4	Power Sequence	17
3.4.5	PCT I2C Timing Specification	18
4.0	OPTICAL SPECIFICATION	19
4.1	Optical Characteristics	19
4.1.1	Test Method	20
5.0	BACKLIGHT SPECIFICATION	21
5.1	LED Driving Conditions	21
5.2	LED Circuit	21
6.0	QUALITY ASSURANCE SPECIFICATION	22
6.1	Delivery Inspection Standards	22
6.1.1	Inspection Conditions	22
6.1.2	Environmental Conditions	22
6.1.3	Sampling Conditions	22



6.1.4 Definition of Area.....	23
6.1.5 Basic Principle	23
6.1.6 Inspection Criteria.....	24
6.1.7 Classification of Defects.....	27
6.1.8 Identification / marking criteria.....	27
6.2 Dealing with Customer Complaints	28
6.2.1 Non-conforming analysis	28
6.2.2 Handling of non-conforming displays.....	28
7.0 RELIABILITY SPECIFICATION.....	29
7.1 Reliability Tests	29
8.0 HANDLING PRECAUTIONS	30

1.0 Main Features

Item	Contents
Screen Size	8.0" Diagonal
Display Format	1600(H) x RGB x 480(V) Dots
N° of Colour	16.7M
Active Area	194.4 mm (H) x 58.32 mm (V)
PCT View Area	195.2mm(H) x 59.12mm (V)
LCD Type	TFT
Mode	Transmissive / Normally Black
Viewing Direction	ALL
TFT Interface	6/8Bit LVDS interface
PCT Interface	USB
Driver IC	HX8249 & HX8678
PCT Driver IC	FT5926QSM
Simultaneous Touch Points	10
Backlight Type	LED
Operating Temperature	-20°C ~ +70°C
Storage Temperature	-30°C ~ +80°C
RoHS compliant	Yes



2.0 Mechanical Specification

2.1 Mechanical Characteristics

Item	Characteristic	Unit
Overall Dimensions	249.2 mm (H) x 87.00 mm (V) x 7.26 mm (D)	mm
Pixel Pitch	121.5 (H) x 121.5 (V)	μm
Weight	173	g

2.2 Mechanical Drawing

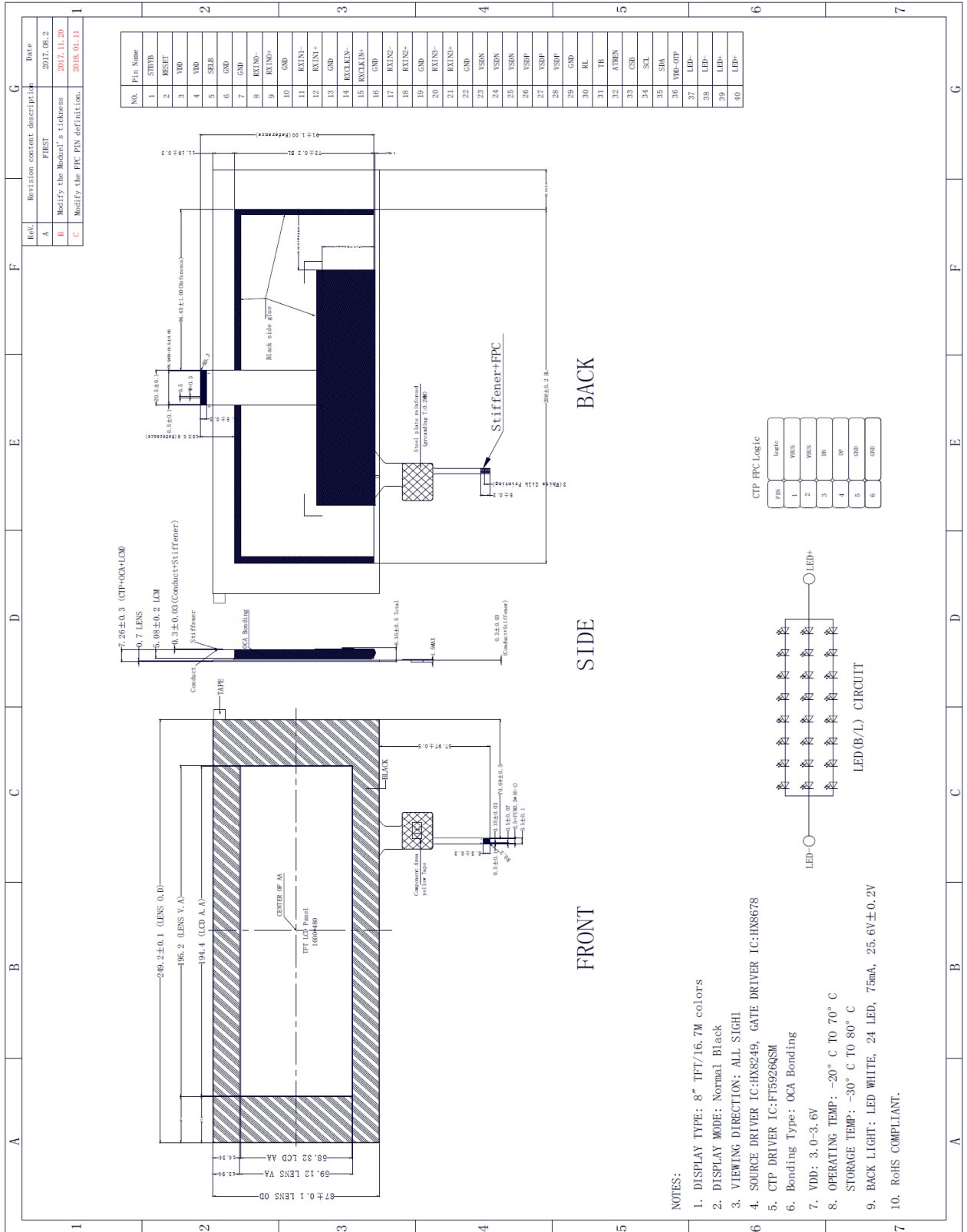

3.0 Electrical Specification

3.1 Absolute Maximum Ratings

3.1.1 TFT

Item	Symbol	Condition	Min	Max	Unit	Note
Power Supply Voltage LCM	VDD	-	2.8	3.6	V	
Operating Temperature	TOP	-	-20	70	°C	1
Storage Temperature	TST	-	-30	80	°C	1,2,3

Note 1. 90 % RH Max for Ta<50 °C, and 60% RH for Ta≥50°C.

Note 2. In case of below 0°C, the response time of liquid crystal (LC) becomes slower and the colour of panel becomes darker than normal one. Level of retardation depends on temperature, because of LC's characteristic.

Note 3. Only operation is guaranteed at operating temperature. Contrast, response time, another display quality are evaluated at +25°C.

3.1.2 PCT

Item	Symbol	Condition	Min	Max	Unit	Note
Power Supply Voltage	VBUS	-	4.0	6.0	V	4
Operating Temperature	TOP	-	-20	70	°C	-
Storage Temperature	TST	-	-30	80	°C	-

Note 4. If used beyond the absolute maximum ratings, FT5926QSM may be permanently damaged. It is strongly recommended that the device be used within the electrical characteristics in normal operations. If exposed to the condition not within the electrical characteristics, it may affect the reliability of the device.

3.2 Electrical Characteristics

3.2.1 TFT

Item		Symbol	Condition	Min	Typ	Max	Unit	Note
Supply Voltage LCM		VDD	Ta=25°C	3.0	3.3	3.5	V	
Supply Voltage IC& GAMA		VSDP	Ta=25°C	5.4	5.5	5.6	V	
Supply Voltage IC& GAMA		VSDN	Ta=25°C	-5.4	-5.5	-5.6	V	
CMOS Interface		VIH		2.6	-	3.3	V	
		VIL		GND	-	0.8	V	
LVDS Interface	Differential Input High Threshold Voltage	VLVTH		100	-	300	mV	
	Differential Input Low Threshold Voltage	VLVTL		-300	-	-100	mV	
	Common Input Voltage	VLVC		1	1.2	1.77-VID/2	V	
	Differential Input Voltage	VID		0.2	-	0.6	V	
Current consumption VSDP		IVSDP		-	25	-	mA	
Current consumption VSDN		IVSDN		-	25	-	mA	
Current Consumption VDD		IDD		-	25	-	mA	1

Note 1: The specified power consumption is under the conditions of VDD=3.3V, FV=60Hz.

3.2.2 PCT

Item	Symbol	Condition	Min	Typ	Max	Unit	Note
Input high-level voltage	VIH	-	0.7 x IOVCC	-	IOVCC	V	
Input low-level voltage	VIL	-	-0.3	-	0.3 x IOVCC	V	
Output high-level voltage	VOH	IOH=-0.1mA	0.7 x IOVCC	-	-	V	
Output low-level voltage	VOL	IOH=0.1mA	-	-	0.3 x IOVCC	V	
I/O Leakage current	ILI	Vin=0~VDDA	-1	-	1	uA	
Normal operation mode Current consumption	Iopr	VDDA=VDD3=2.8 V Ta=25°C MCLK=24MHZ	-	16.68	-	mA	RMS
Green mode Current consumption	Imon	VDDA=VDD3=2.8 V Ta=25°C MCLK=24MHZ	-	8.56	-	mA	RMS
Sleep mode Current Consumption	Islp	VDDA=VDD3=2.8 V Ta=25°C MCLK=24MHZ	-	≤200	-	uA	RMS
Step-up output voltage	VDD5	VDDA=VDD3=2.8 V	4.5	5.0	5.2	V	
Power supply voltage	VDDA VDD3	-	2.8	-	3.6	V	
Power Consumption	-	-	-	16.68	-	mA	Active
	-	-	-	8.56	-	mA	Monitor
	-	-	-	187.5	-	uA	Sleep



3.3 Interface Pin Assignment

3.3.1 LCM Pin Assignment

Recommended connector: FH12A-40S-0.5SH (HIROSE)

No.	Symbol	Function
1	STBYB	Enable IC(Note1)
2	RESET	RESET IC(Note2)
3	VDD	Digital power 3.3V
4	VDD	Digital power 3.3V
5	SELB	6bit/8bit mode select(Note3)
6	GND	Ground
7	GND	Ground
8	RXIN0-	Negative LVDS differential data input
9	RXIN0+	Positive LVDS differential data input
10	GND	Ground
11	RXIN1-	Negative LVDS differential data input
12	RXIN1+	Positive LVDS differential data input
13	GND	Ground
14	RXCLKIN-	Negative LVDS differential data input
15	RXCLKIN+	Positive LVDS differential data input
16	GND	Ground
17	RXIN2-	Negative LVDS differential data input
18	RXIN2+	Positive LVDS differential data input
19	GND	Ground
20	RXIN3-	Negative LVDS differential data input
21	RXIN3+	Positive LVDS differential data input
22	GND	Ground
23	VSDN	Power for Driver IC
24	VSDN	Power for Driver IC
25	VSDN	Power for Driver IC

No.	Symbol	Function
26	VSDP	Power for Driver IC
27	VSDP	Power for Driver IC
28	VSDP	Power for Driver IC
29	GND	Ground
30	RL	Horizontal shift direction(Note4)
31	TB	Vertical shift direction(Note4)
32	ATREN	Only for OTP program
33	CSB	SPI
34	SCL	SPI
35	SDA	SPI
36	VDD_OTP	7.5V for OTP program
37	LED-	LED Cathode
38	LED-	LED Cathode
39	LED+	LED Anode
40	LED+	LED Anode

Note.1

STBYB=H(3.3V),normal operation.

STBYB=L(GND),timing controller,source driver will run off,all opout are High-Z.

Note.2

Suggest to connection with an RC reset circuit for stability,Normally pull high.

(47KΩ+0.1uF or extinal MCU control)

Note.3

If LVDS iput data is 8 bit,SELB must be set to high.

Note.4

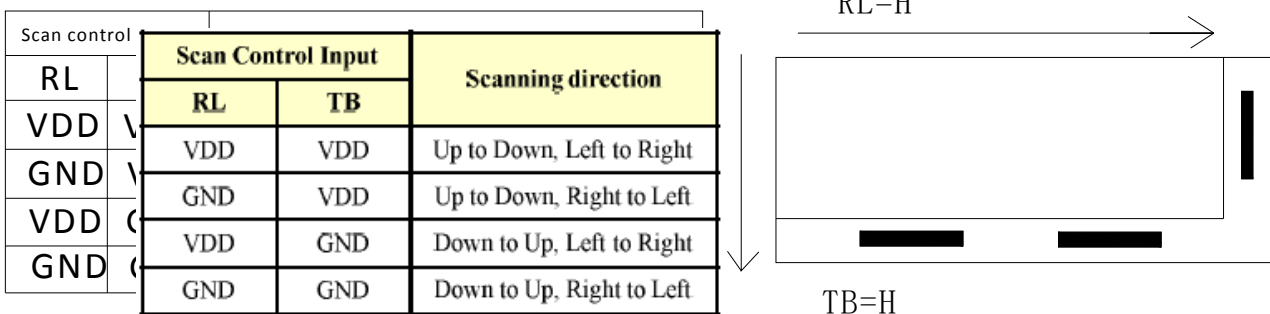

3.3.2 PCT PIN ASSIGNMENT

NO.	SYMBOL	DISCRIPTION
1	VBUS	Supply voltage (4.5-5.5V)
2	VBUS	Supply voltage (4.5-5.5V)
3	DN	USB D-
4	DP	USB D+
5	GND	Ground
6	GND	Ground

3.4 Timing Characteristics

3.4.1 Timing Parameters(Sync mode)

Parameter	Symbol	Value			Unit.	Note
		Min.	Typ.	Max.		
DCLK Frequency	FDCLK	48.69	52.59	60.83	MHZ	
Horizontal valid data	thd	1600			DCLK	
Hsync Pulse Width	thpw	1	2	140	DCLK	
Hsync back porch	thbp	5	16	141	DCLK	
Hsync front porch	thfp	19	44	155	DCLK	
1 Horizontal Line	th	1656	1660	1760	DCLK	
Vertical valid data	tvd	480			H	
Vsync Pulse Width	tvpw	1	2	90	H	
Vsync back porch	tvbp	5	5	91	H	
Vsync front porch	tvfp	5	43	91	H	
1 Vertical field	tv	490	528	576	H	

Notes: This product is Sync mode

8-bit LVDS input (HSD='L')

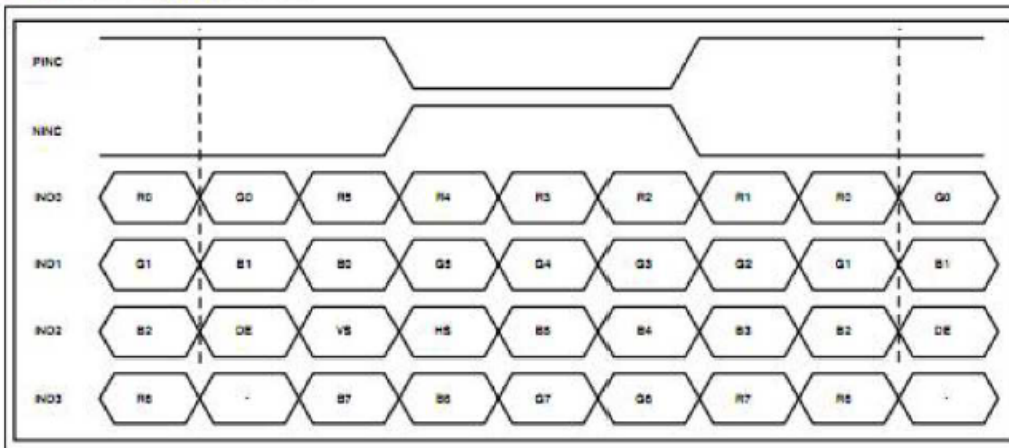

3.4.2 LVDS Rx Interface Timing Parameter

Parameter	Symbol	Value			Unit.	Condition
		Min.	Typ.	Max.		
Clock frequency	RxFCLK	TBD	TBD	TBD	MHz	
Input data skew margin	TRSKM	500	-	-	ps	VID =400mV, RxVCM=1.2V, RxFCLK=71MHz
Clock high time	TLVCH	-	4/(7*RxFCLK)	-	ns	
Clock low time	TLVCL	-	3/(7*RxFCLK)	-	ns	
PLL wake-up time	TenPLL	-	-	150	us	

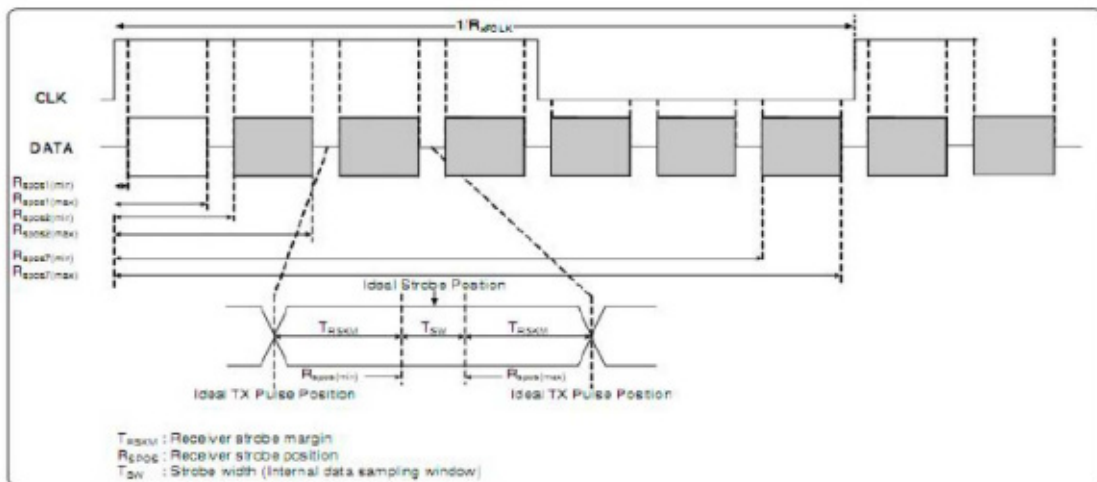
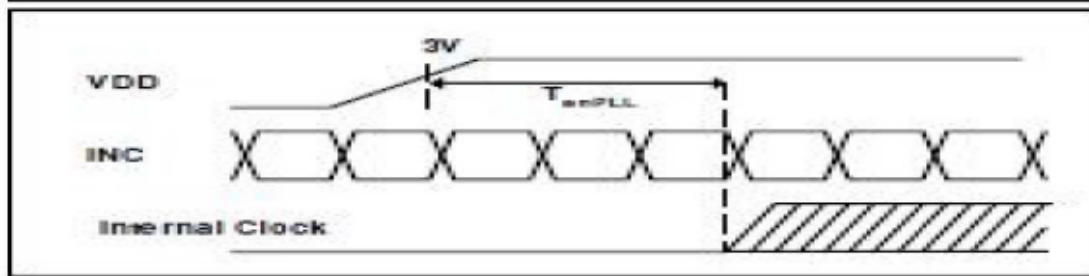
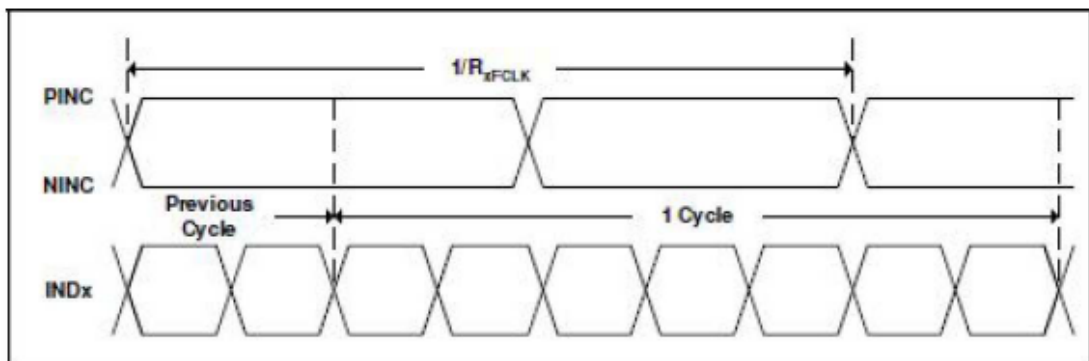

3.4.3 Input Signals, Basic Display Colors & Gray Scale Of Colors

Color & Gray Scale		Input Data Signal																						
		Red Data								Green Data				Blue Data										
		R7	R6	R5	R4	R3	R2	R1	R0	G7	G6	G5	G4	G3	G2	G1	G0	B7	B6	B5	B4	B3	B2	B1
Basic Colors	Black	0	0	0	0	0	0	0	0	0	0	0	0	0	0	0	0	0	0	0	0	0	0	0
	Blue	0	0	0	0	0	0	0	0	0	0	0	0	0	0	0	0	1	1	1	1	1	1	1
	Green	0	0	0	0	0	0	0	0	1	1	1	1	1	1	1	0	0	0	0	0	0	0	0
	Cyan	0	0	0	0	0	0	0	0	1	1	1	1	1	1	1	1	1	1	1	1	1	1	1
	Red	1	1	1	1	1	1	1	0	0	0	0	0	0	0	0	0	0	0	0	0	0	0	0
	Magenta	1	1	1	1	1	1	1	0	0	0	0	0	0	0	0	0	1	1	1	1	1	1	1
	Yellow	1	1	1	1	1	1	1	1	1	1	1	1	1	1	0	0	0	0	0	0	0	0	0
	White	1	1	1	1	1	1	1	1	1	1	1	1	1	1	1	1	1	1	1	1	1	1	1
Gray Scale of Red	Black	0	0	0	0	0	0	0	0	0	0	0	0	0	0	0	0	0	0	0	0	0	0	
	△	0	0	0	0	0	0	0	1	0	0	0	0	0	0	0	0	0	0	0	0	0	0	
	Darker	0	0	0	0	0	0	0	1	0	0	0	0	0	0	0	0	0	0	0	0	0	0	
	△																							
	▽																							
	Brighter	1	1	1	1	1	1	0	1	0	0	0	0	0	0	0	0	0	0	0	0	0	0	
	▽	1	1	1	1	1	1	0	0	0	0	0	0	0	0	0	0	0	0	0	0	0	0	
	Red	1	1	1	1	1	1	1	0	0	0	0	0	0	0	0	0	0	0	0	0	0	0	0
Gray Scale of Green	Black	0	0	0	0	0	0	0	0	0	0	0	0	0	0	0	0	0	0	0	0	0	0	
	△	0	0	0	0	0	0	0	0	0	0	0	0	0	0	1	0	0	0	0	0	0	0	
	Darker	0	0	0	0	0	0	0	0	0	0	0	0	0	1	0	0	0	0	0	0	0	0	
	△																							
	▽																							
	Brighter	0	0	0	0	0	0	0	0	1	1	1	1	1	1	0	1	0	0	0	0	0	0	
	▽	0	0	0	0	0	0	0	0	1	1	1	1	1	1	0	0	0	0	0	0	0	0	
	Green	0	0	0	0	0	0	0	0	1	1	1	1	1	1	1	0	0	0	0	0	0	0	0
Gray Scale of Blue	Black	0	0	0	0	0	0	0	0	0	0	0	0	0	0	0	0	0	0	0	0	0	0	
	△	0	0	0	0	0	0	0	0	0	0	0	0	0	0	0	0	0	0	0	0	0	1	
	Darker	0	0	0	0	0	0	0	0	0	0	0	0	0	0	0	0	0	0	0	0	0	1	
	△																							
	▽																							
	Brighter	0	0	0	0	0	0	0	0	0	0	0	0	0	0	0	0	1	1	1	1	1	1	
	▽	0	0	0	0	0	0	0	0	0	0	0	0	0	0	0	0	1	1	1	1	1	1	
	Blue	0	0	0	0	0	0	0	0	0	0	0	0	0	0	0	0	1	1	1	1	1	1	
Gray Scale of White	Black	0	0	0	0	0	0	0	0	0	0	0	0	0	0	0	0	0	0	0	0	0	0	
	△	0	0	0	0	0	0	0	1	0	0	0	0	0	0	1	0	0	0	0	0	0	1	
	Darker	0	0	0	0	0	0	1	0	0	0	0	0	0	1	0	0	0	0	0	0	0	1	
	△																							
	▽																							
	Brighter	1	1	1	1	1	1	0	1	1	1	1	1	1	0	1	1	1	1	1	1	1	0	
	▽	1	1	1	1	1	1	0	1	1	1	1	1	1	1	0	1	1	1	1	1	1	0	
	White	1	1	1	1	1	1	1	1	1	1	1	1	1	1	1	1	1	1	1	1	1	1	

3.4.4 Power Sequence

Power on Sequence

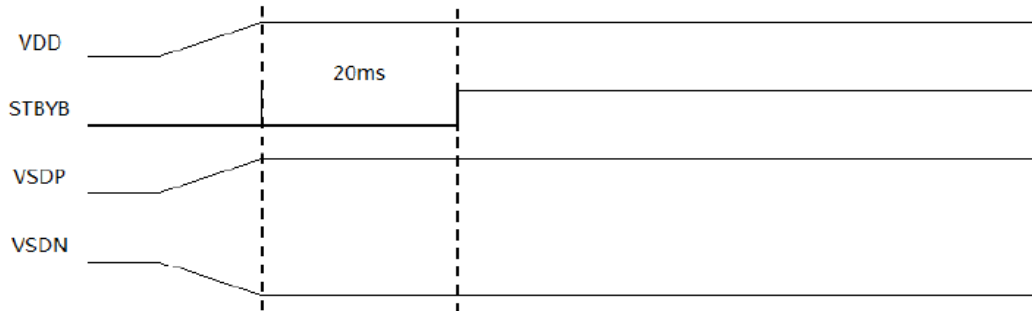

Notes:

1. When the power supply VDD is 0V, keep the level of input signals on the low or keep high impedance.
2. Do not keep the interface signal high impedance when power is on. Back Light must turn on after power for logic and interface signal are valid.

Power off Sequence

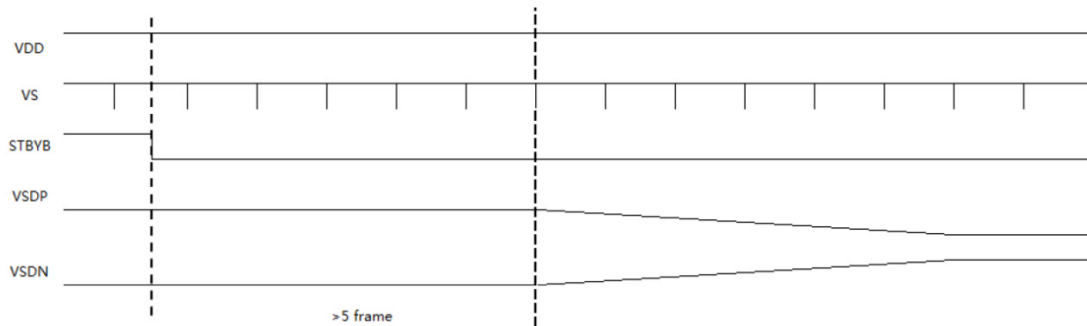

3.4.5 PCT I2C Timing Specification

Power on Sequence

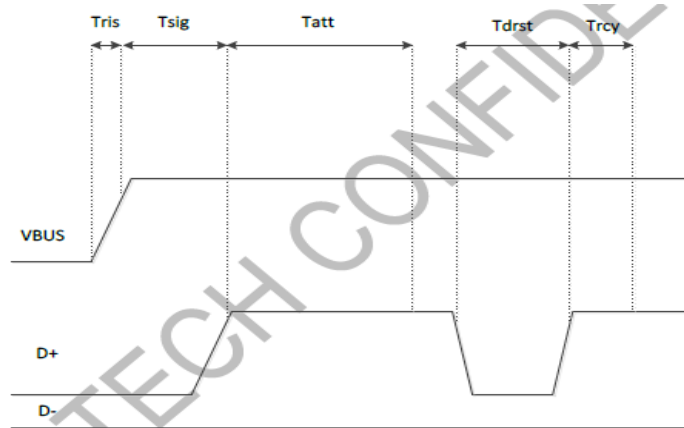

Figure 3-11 Power on / down Sequence

Table 3-7 USB Power on/Reset Sequence Parameters

Parameter	Description	Min	Max	Units
Tris	Rise time from 0.1VDD to 0.9VDD	--	5	ms
Tsig	Time required for the device internal power rail to stabilize and for D+ or D- to reach VIH (min)	100	--	ms
Tatt	Time ensures that the electrical and mechanical connection is stable before software attempts to reset the attached device	100	--	ms
Tdrst	Time hubs drive reset to a device	10	--	ms
Trcy	The USB System Software guarantees a minimum of 10 ms for reset recovery	10	--	ms

4.0 Optical Specification

4.1 Optical Characteristics

Measuring instruments : LCD-5100, Eldim, Topcon BM-7
 Driving condition: VDD = 3.3V, VSS = 0V
 Backlight: IF=75mA
 Measured temperature: Ta = 25 °C

Item	Symbol	Condition	Min	Typ	Max	Unit	Note	
Response Time	TR+TF	$\theta=\phi=0^\circ$ Normal Viewing Angle	-	25	35	ms	2	
Contrast Ratio	CR		700	900	-		3	
Viewing Angle	Left	θ_L	CR \geq 10	-	85	-	deg	4
	Right	θ_R		-	85	-	deg	
	Up	ϕ_U		-	85	-	deg	
	Down	ϕ_D		-	85	-	deg	
Colour Chromaticity	Red	Rx	CR \geq 10	0.598	0.608	0.628	-	5
		Ry		0.329	0.349	0.369	-	
	Green	Gx		0.267	0.307	0.327	-	
		Gy		0.527	0.547	0.567	-	
	Blue	Bx		0.122	0.142	0.162	-	
		By		0.070	0.090	0.110	-	
	White	Wx		0.252	0.292	0.332	-	
		Wy		0.255	0.295	0.335	-	
Centre Brightness			375	425	-	cd/m ²	6	
Brightness Distribution			80	-	-	%	7	

4.1.1 Test Method

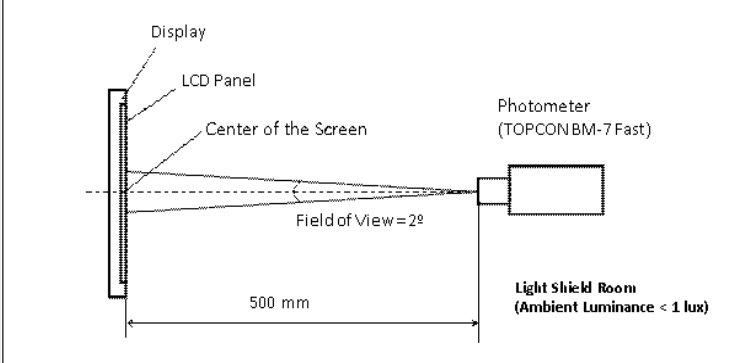
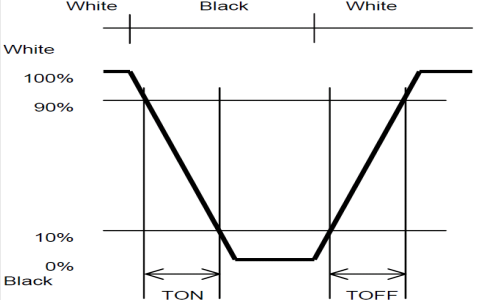
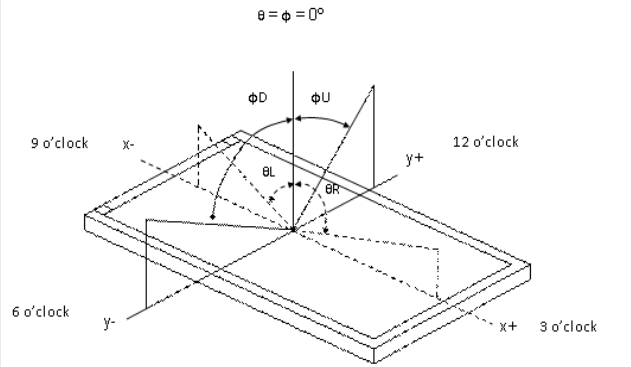
Note	Item	Test Method
1	Setup	<p>The display should be stabilised at a given temperature for 30 minutes to avoid abrupt temperature change during measuring. In order to stabilise the luminance, measurements should be executed after lighting the backlight for 30 minutes in a windless room.</p> 
2	Response time	<p>Measure output signal waveform by the luminance meter when raster of window pattern is changed from white to black and from black to white.</p> 
3	Contrast ratio	<p>Measure maximum brightness and minimum brightness at the centre of the screen by displaying raster or window pattern. Then calculate the ratio between these two values.</p> $\text{Contrast Ratio (CR)} = \frac{\text{Brightness of unselected position (white)}}{\text{Brightness of selected position (black)}}$
4	Viewing angle Horizontal θ Vertical ϕ	<p>Move the luminance meter from right to left and up and down and determine the angles where contrast ratio is 10</p> 
5	Colour chromaticity	Measure chromaticity coordinates x and y of CIE1931 colorimetric system
6	Centre brightness	Measure the brightness at the centre of the screen
7	Brightness distribution	<p>(Brightness distribution) = $100 \times B/A \%$ A: max. brightness of the 9 points B: min. brightness of the 9 points</p>

5.0 Backlight Specification

5.1 LED Driving Conditions

Item	Symbol	Condition	Min	Typ	Max	Unit
Forward Current	IF	Ta=25 °C	60	75	-	mA
Forward Voltage	VF	Ta= 25°C		25.6		V
LED life time	Hr				50k	hour

Note:

- The lifetime of the LED is defined as a period till the brightness of the LED decreases to the half of its initial value.
- This figure is given as a reference purpose only, and not a guarantee.
- This figure is estimated for an LED operating alone.
The performance of an LED may differ when assembled as a monitor together with a TFT panel due to different environmental temperature.
- Estimated lifetime could vary on a different temperature and usually higher temperature could reduce the life significantly.

5.2 LED Circuit

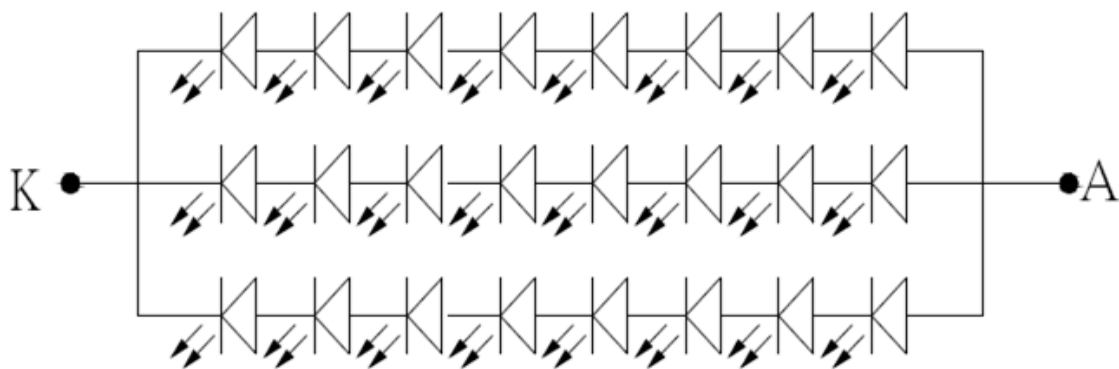

LED Circuit Drawing

6.0 Quality Assurance Specification

6.1 Delivery Inspection Standards

6.1.1 Inspection Conditions

Inspection distance: 30 cm ± 2 cm

Viewing angle: ±45°

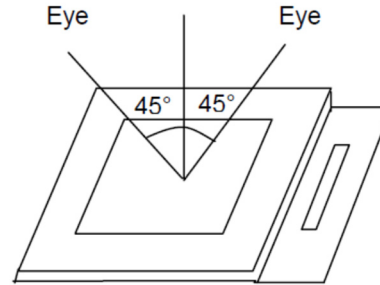

6.1.2 Environmental Conditions

Ambient temperature: 25°C ±5°C

Ambient humidity: 65±10% RH

Ambient illumination: 300~700 lux

6.1.3 Sampling Conditions

1. Lot size: quantity of shipment lot per model
2. Sampling method:

Sampling Plan		GB/T 2828-2003
		Normal inspection, Class II
AQL	Major Defect	0.65%
	Minor Defect	1.5%

No	Items to be inspected	Criteria	Classification of defects
1	Functional defects	1) No display, Open or miss line 2) Display abnormally, Short 3) Backlight no lighting, abnormal lighting. 4) TP no function	Major
2	Missing	Missing component	
3	Outline dimension	Overall outline dimension beyond the drawing is not allowed	
4	Color tone	Color unevenness, refer to limited sample	Minor
5	Spot Line defect	Light dot , Dim spot,Polarizer Bubble ; Polarizer accidented spot.	
6	Soldering appearance	Good soldering , Peeling off is not allowed.	

6.1.4 Definition of Area

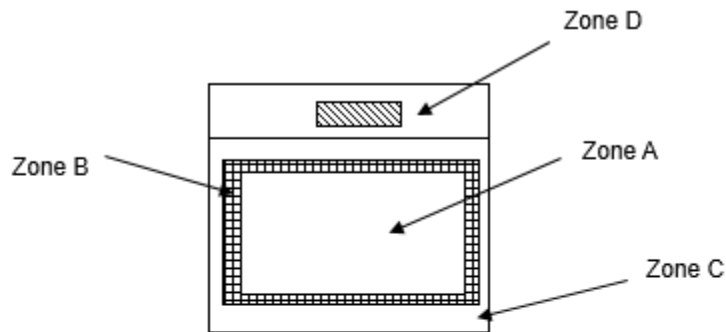

Zone A : Effective Viewing Area(Character or Digit can be seen)

Zone B : Viewing Area except Zone A

Zone C Cover (Zone A+Zone B) which can not be seen after assembly by customer .)

Zone D : IC Bonding Area

Note:

As a general rule ,visual defects in Zone C can be ignored when it doesn't effect product function or appearance after assembly by customer

6.1.5 Basic Principle

A set of sample to indicate the limit of acceptable quality level shall be discussed should a dispute occur.

6.1.6 Inspection Criteria

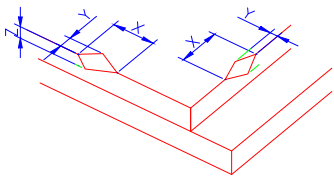
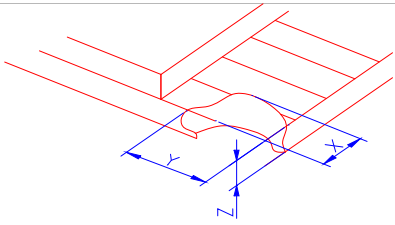
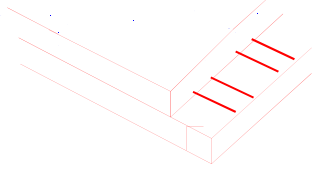
Number	Items	Criteria(mm)						
1.0 LCD Crack/Broken NOTE: X: Length Y: Width Z: Height L: Length of ITO T: Height of LCD	(1) The edge of LCD broken	 <table border="1" data-bbox="687 548 1471 701"> <thead> <tr> <th data-bbox="687 548 911 622">X</th> <th data-bbox="911 548 1294 622">Y</th> <th data-bbox="1294 548 1471 622">Z</th> </tr> </thead> <tbody> <tr> <td data-bbox="687 622 911 701">≤3.0mm</td> <td data-bbox="911 622 1294 701"><Inner border line of the seal</td> <td data-bbox="1294 622 1471 701">≤T</td> </tr> </tbody> </table>	X	Y	Z	≤3.0mm	<Inner border line of the seal	≤T
		X	Y	Z				
		≤3.0mm	<Inner border line of the seal	≤T				
(2) LCD corner broken	 <table border="1" data-bbox="687 1003 1471 1155"> <thead> <tr> <th data-bbox="687 1003 956 1077">X</th> <th data-bbox="956 1003 1190 1077">Y</th> <th data-bbox="1190 1003 1471 1077">Z</th> </tr> </thead> <tbody> <tr> <td data-bbox="687 1077 956 1155">≤3.0mm</td> <td data-bbox="956 1077 1190 1155">≤L</td> <td data-bbox="1190 1077 1471 1155">≤T</td> </tr> </tbody> </table>	X	Y	Z	≤3.0mm	≤L	≤T	
X	Y	Z						
≤3.0mm	≤L	≤T						
(3) LCD crack	 <p data-bbox="994 1447 1137 1507">Crack Not allowed</p>							

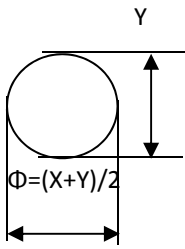
2.0 	Spot defect	① light dot (LCD/TP/Polarizer black/white spot , light dot, pinhole, dent, stain) <table border="1"> <thead> <tr> <th rowspan="2">Size (mm) \ Zone</th> <th colspan="3">Acceptable Qty</th> </tr> <tr> <th>A</th> <th>B</th> <th>C</th> </tr> </thead> <tbody> <tr> <td>$\Phi \leq 0.10$</td> <td colspan="3">Ignore</td> </tr> <tr> <td>$0.10 < \Phi \leq 0.25$</td> <td colspan="3">4(distance $\geq 10\text{mm}$)</td> </tr> <tr> <td>$0.25 < \Phi \leq 0.35$</td> <td colspan="3">3</td> </tr> <tr> <td>$\Phi > 0.4$</td> <td colspan="3">0</td> </tr> </tbody> </table>	Size (mm) \ Zone	Acceptable Qty			A	B	C	$\Phi \leq 0.10$	Ignore			$0.10 < \Phi \leq 0.25$	4(distance $\geq 10\text{mm}$)			$0.25 < \Phi \leq 0.35$	3			$\Phi > 0.4$	0		
	Size (mm) \ Zone	Acceptable Qty																							
		A	B	C																					
	$\Phi \leq 0.10$	Ignore																							
	$0.10 < \Phi \leq 0.25$	4(distance $\geq 10\text{mm}$)																							
$0.25 < \Phi \leq 0.35$	3																								
$\Phi > 0.4$	0																								
② Dim spot (LCD/TP/Polarizer dim dot, light leakage, dark spot) <table border="1"> <thead> <tr> <th rowspan="2">Size (mm) \ Zone</th> <th colspan="3">Acceptable Qty</th> </tr> <tr> <th>A</th> <th>B</th> <th>C</th> </tr> </thead> <tbody> <tr> <td>$\Phi \leq 0.1$</td> <td colspan="3">Ignore</td> </tr> <tr> <td>$0.10 < \Phi \leq 0.25$</td> <td colspan="3">4(distance $\geq 10\text{mm}$)</td> </tr> <tr> <td>$0.25 < \Phi \leq 0.35$</td> <td colspan="3">3</td> </tr> <tr> <td>$\Phi > 0.4$</td> <td colspan="3">0</td> </tr> </tbody> </table>	Size (mm) \ Zone	Acceptable Qty			A	B	C	$\Phi \leq 0.1$	Ignore			$0.10 < \Phi \leq 0.25$	4(distance $\geq 10\text{mm}$)			$0.25 < \Phi \leq 0.35$	3			$\Phi > 0.4$	0				
Size (mm) \ Zone		Acceptable Qty																							
	A	B	C																						
$\Phi \leq 0.1$	Ignore																								
$0.10 < \Phi \leq 0.25$	4(distance $\geq 10\text{mm}$)																								
$0.25 < \Phi \leq 0.35$	3																								
$\Phi > 0.4$	0																								
③ Polarizer accidented spot <table border="1"> <thead> <tr> <th rowspan="2">Size (mm) \ Zone</th> <th colspan="3">Acceptable Qty</th> </tr> <tr> <th>A</th> <th>B</th> <th>C</th> </tr> </thead> <tbody> <tr> <td>$\Phi \leq 0.2$</td> <td colspan="3">Ignore</td> </tr> <tr> <td>$0.3 < \Phi \leq 0.5$</td> <td colspan="3">3(distance $\geq 10\text{mm}$)</td> </tr> <tr> <td>$\Phi > 0.5$</td> <td colspan="3">1</td> </tr> </tbody> </table>	Size (mm) \ Zone	Acceptable Qty			A	B	C	$\Phi \leq 0.2$	Ignore			$0.3 < \Phi \leq 0.5$	3(distance $\geq 10\text{mm}$)			$\Phi > 0.5$	1								
Size (mm) \ Zone		Acceptable Qty																							
	A	B	C																						
$\Phi \leq 0.2$	Ignore																								
$0.3 < \Phi \leq 0.5$	3(distance $\geq 10\text{mm}$)																								
$\Phi > 0.5$	1																								
④ Pixel bad points (light dot, Dim dot, color dot) <table border="1"> <thead> <tr> <th rowspan="2">Size (mm) \ Zone</th> <th colspan="3">Acceptable Qty</th> </tr> <tr> <th>A</th> <th>B</th> <th>C</th> </tr> </thead> <tbody> <tr> <td>$\Phi \leq 0.15$</td> <td colspan="3">Ignore</td> </tr> <tr> <td>$0.2 < \Phi \leq 0.3$</td> <td colspan="3">2(distance $\geq 10\text{mm}$)</td> </tr> <tr> <td>$\Phi > 0.4$</td> <td colspan="3">1</td> </tr> </tbody> </table>	Size (mm) \ Zone	Acceptable Qty			A	B	C	$\Phi \leq 0.15$	Ignore			$0.2 < \Phi \leq 0.3$	2(distance $\geq 10\text{mm}$)			$\Phi > 0.4$	1								
Size (mm) \ Zone		Acceptable Qty																							
	A	B	C																						
$\Phi \leq 0.15$	Ignore																								
$0.2 < \Phi \leq 0.3$	2(distance $\geq 10\text{mm}$)																								
$\Phi > 0.4$	1																								
⑤ Polarizer Bubble <table border="1"> <thead> <tr> <th rowspan="2">Size (mm) \ Zone</th> <th colspan="3">Acceptable Qty</th> </tr> <tr> <th>A</th> <th>B</th> <th>C</th> </tr> </thead> <tbody> <tr> <td>$\Phi \leq 0.2$</td> <td colspan="3">Ignore</td> </tr> <tr> <td>$0.3 < \Phi \leq 0.4$</td> <td colspan="3">4(distance $\geq 10\text{m}$)</td> </tr> <tr> <td>$0.4 < \Phi \leq 0.5$</td> <td colspan="3">3</td> </tr> <tr> <td>$\Phi > 0.5$</td> <td colspan="3">1</td> </tr> </tbody> </table>	Size (mm) \ Zone	Acceptable Qty			A	B	C	$\Phi \leq 0.2$	Ignore			$0.3 < \Phi \leq 0.4$	4(distance $\geq 10\text{m}$)			$0.4 < \Phi \leq 0.5$	3			$\Phi > 0.5$	1				
Size (mm) \ Zone		Acceptable Qty																							
	A	B	C																						
$\Phi \leq 0.2$	Ignore																								
$0.3 < \Phi \leq 0.4$	4(distance $\geq 10\text{m}$)																								
$0.4 < \Phi \leq 0.5$	3																								
$\Phi > 0.5$	1																								

3.0	Line defect (LCD/TP/Polarizer backlight black/white line, scratch, stain)	<table border="1"> <thead> <tr> <th rowspan="2">Width(mm)</th> <th rowspan="2">Length(mm)</th> <th colspan="3">Acceptable Qty</th> </tr> <tr> <th>A</th> <th>B</th> <th>C</th> </tr> </thead> <tbody> <tr> <td>$\Phi \leq 0.05$</td> <td>Ignore</td> <td colspan="3">Ignore</td> </tr> <tr> <td>$0.05 < W \leq 0.06$</td> <td>$L \leq 4.0$</td> <td colspan="3">$N \leq 3$</td> </tr> <tr> <td>$0.07 < W \leq 0.08$</td> <td>$L \leq 3.0$</td> <td colspan="3">$N \leq 2$</td> </tr> <tr> <td>$0.08 < W$</td> <td colspan="4">Define as spot defect</td> </tr> </tbody> </table>	Width(mm)	Length(mm)	Acceptable Qty			A	B	C	$\Phi \leq 0.05$	Ignore	Ignore			$0.05 < W \leq 0.06$	$L \leq 4.0$	$N \leq 3$			$0.07 < W \leq 0.08$	$L \leq 3.0$	$N \leq 2$			$0.08 < W$	Define as spot defect																																																																													
		Width(mm)			Length(mm)	Acceptable Qty																																																																																																		
			A	B		C																																																																																																		
		$\Phi \leq 0.05$	Ignore	Ignore																																																																																																				
		$0.05 < W \leq 0.06$	$L \leq 4.0$	$N \leq 3$																																																																																																				
$0.07 < W \leq 0.08$	$L \leq 3.0$	$N \leq 2$																																																																																																						
$0.08 < W$	Define as spot defect																																																																																																							
4.0	Electronic Components SMT	Not allow missing parts, solderless connection, cold solder joint, mismatch, The positive and negative polarity opposite																																																																																																						
5.0	Display color & Brightness	<ol style="list-style-type: none"> Color : Measuring the color coordinates, The measurement standard according to the datasheet or samples. Brightness : Measuring the brightness of White screen, The measurement standard according to the datasheet or Samples. 																																																																																																						
6.0	CTP Related	<table border="1"> <tr> <td rowspan="5">CTP Cover sensor accidented black/white spot</td> <td> <table border="1"> <thead> <tr> <th rowspan="2">Size Φ(mm)</th> <th colspan="3">Acceptable Qty</th> </tr> <tr> <th>A</th> <th>B</th> <th>C</th> </tr> </thead> <tbody> <tr> <td>$\Phi \leq 0.1$</td> <td colspan="3">Ignore</td> </tr> <tr> <td>$0.15 < \Phi \leq 0.25$</td> <td colspan="3">4 (distance ≥ 10mm)</td> </tr> <tr> <td>$0.25 < \Phi \leq 0.35$</td> <td colspan="3">3</td> </tr> <tr> <td>$\Phi > 0.4$</td> <td colspan="3">1</td> </tr> </tbody> </table> </td> </tr> <tr> <td> <table border="1"> <thead> <tr> <th rowspan="2">Width(mm)</th> <th rowspan="2">Ignore(mm)</th> <th colspan="3">Acceptable Qty</th> </tr> <tr> <th>A</th> <th>B</th> <th>C</th> </tr> </thead> <tbody> <tr> <td>$\Phi \leq 0.05$</td> <td>Ignore</td> <td colspan="3">Ignore</td> </tr> <tr> <td>$0.05 < W \leq 0.06$</td> <td>$L \leq 4.0$</td> <td colspan="3">$N \leq 3$</td> </tr> <tr> <td>$0.07 < W \leq 0.08$</td> <td>$L \leq 3.0$</td> <td colspan="3">$N \leq 2$</td> </tr> <tr> <td>$0.08 < W$</td> <td colspan="4">Define as spot defect</td> </tr> </tbody> </table> </td> </tr> <tr> <td> <table border="1"> <thead> <tr> <th rowspan="2">Zone Size (mm)</th> <th colspan="3">Acceptable Qty</th> </tr> <tr> <th colspan="3">C</th> </tr> </thead> <tbody> <tr> <td>$\Phi \leq 0.2$</td> <td colspan="3">Ignore</td> </tr> <tr> <td>$0.2 < \Phi \leq 0.3$</td> <td colspan="3">4(distance ≥ 10mm)</td> </tr> <tr> <td>$0.3 < \Phi \leq 0.4$</td> <td colspan="3">3</td> </tr> <tr> <td>$\Phi > 0.4$</td> <td colspan="3">0</td> </tr> </tbody> </table> </td> </tr> <tr> <td> <table border="1"> <tr> <td rowspan="5">CTP Bonding bubble/ accidented spot</td> <td> <table border="1"> <thead> <tr> <th rowspan="2">Size Φ(mm)</th> <th colspan="2">Acceptable Qty</th> </tr> <tr> <th>A</th> <th>B</th> </tr> </thead> <tbody> <tr> <td>$\Phi \leq 0.1$</td> <td colspan="2">Ignore</td> </tr> <tr> <td>$0.15 < \Phi \leq 0.2$</td> <td colspan="2">3(distance ≥ 10mm)</td> </tr> <tr> <td>$0.2 < \Phi \leq 0.25$</td> <td colspan="2">2</td> </tr> <tr> <td>$\Phi > 0.25$</td> <td colspan="2">0</td> </tr> </tbody> </table> </td> </tr> <tr> <td>Assembly deflection</td> <td colspan="3">beyond the edge of backlight ≤ 0.2mm</td> </tr> </table> </td></tr></table>	CTP Cover sensor accidented black/white spot	<table border="1"> <thead> <tr> <th rowspan="2">Size Φ(mm)</th> <th colspan="3">Acceptable Qty</th> </tr> <tr> <th>A</th> <th>B</th> <th>C</th> </tr> </thead> <tbody> <tr> <td>$\Phi \leq 0.1$</td> <td colspan="3">Ignore</td> </tr> <tr> <td>$0.15 < \Phi \leq 0.25$</td> <td colspan="3">4 (distance ≥ 10mm)</td> </tr> <tr> <td>$0.25 < \Phi \leq 0.35$</td> <td colspan="3">3</td> </tr> <tr> <td>$\Phi > 0.4$</td> <td colspan="3">1</td> </tr> </tbody> </table>	Size Φ (mm)	Acceptable Qty			A	B	C	$\Phi \leq 0.1$	Ignore			$0.15 < \Phi \leq 0.25$	4 (distance ≥ 10 mm)			$0.25 < \Phi \leq 0.35$	3			$\Phi > 0.4$	1			<table border="1"> <thead> <tr> <th rowspan="2">Width(mm)</th> <th rowspan="2">Ignore(mm)</th> <th colspan="3">Acceptable Qty</th> </tr> <tr> <th>A</th> <th>B</th> <th>C</th> </tr> </thead> <tbody> <tr> <td>$\Phi \leq 0.05$</td> <td>Ignore</td> <td colspan="3">Ignore</td> </tr> <tr> <td>$0.05 < W \leq 0.06$</td> <td>$L \leq 4.0$</td> <td colspan="3">$N \leq 3$</td> </tr> <tr> <td>$0.07 < W \leq 0.08$</td> <td>$L \leq 3.0$</td> <td colspan="3">$N \leq 2$</td> </tr> <tr> <td>$0.08 < W$</td> <td colspan="4">Define as spot defect</td> </tr> </tbody> </table>	Width(mm)	Ignore(mm)	Acceptable Qty			A	B	C	$\Phi \leq 0.05$	Ignore	Ignore			$0.05 < W \leq 0.06$	$L \leq 4.0$	$N \leq 3$			$0.07 < W \leq 0.08$	$L \leq 3.0$	$N \leq 2$			$0.08 < W$	Define as spot defect				<table border="1"> <thead> <tr> <th rowspan="2">Zone Size (mm)</th> <th colspan="3">Acceptable Qty</th> </tr> <tr> <th colspan="3">C</th> </tr> </thead> <tbody> <tr> <td>$\Phi \leq 0.2$</td> <td colspan="3">Ignore</td> </tr> <tr> <td>$0.2 < \Phi \leq 0.3$</td> <td colspan="3">4(distance ≥ 10mm)</td> </tr> <tr> <td>$0.3 < \Phi \leq 0.4$</td> <td colspan="3">3</td> </tr> <tr> <td>$\Phi > 0.4$</td> <td colspan="3">0</td> </tr> </tbody> </table>	Zone Size (mm)	Acceptable Qty			C			$\Phi \leq 0.2$	Ignore			$0.2 < \Phi \leq 0.3$	4(distance ≥ 10 mm)			$0.3 < \Phi \leq 0.4$	3			$\Phi > 0.4$	0			<table border="1"> <tr> <td rowspan="5">CTP Bonding bubble/ accidented spot</td> <td> <table border="1"> <thead> <tr> <th rowspan="2">Size Φ(mm)</th> <th colspan="2">Acceptable Qty</th> </tr> <tr> <th>A</th> <th>B</th> </tr> </thead> <tbody> <tr> <td>$\Phi \leq 0.1$</td> <td colspan="2">Ignore</td> </tr> <tr> <td>$0.15 < \Phi \leq 0.2$</td> <td colspan="2">3(distance ≥ 10mm)</td> </tr> <tr> <td>$0.2 < \Phi \leq 0.25$</td> <td colspan="2">2</td> </tr> <tr> <td>$\Phi > 0.25$</td> <td colspan="2">0</td> </tr> </tbody> </table> </td> </tr> <tr> <td>Assembly deflection</td> <td colspan="3">beyond the edge of backlight ≤ 0.2mm</td> </tr> </table>	CTP Bonding bubble/ accidented spot	<table border="1"> <thead> <tr> <th rowspan="2">Size Φ(mm)</th> <th colspan="2">Acceptable Qty</th> </tr> <tr> <th>A</th> <th>B</th> </tr> </thead> <tbody> <tr> <td>$\Phi \leq 0.1$</td> <td colspan="2">Ignore</td> </tr> <tr> <td>$0.15 < \Phi \leq 0.2$</td> <td colspan="2">3(distance ≥ 10mm)</td> </tr> <tr> <td>$0.2 < \Phi \leq 0.25$</td> <td colspan="2">2</td> </tr> <tr> <td>$\Phi > 0.25$</td> <td colspan="2">0</td> </tr> </tbody> </table>	Size Φ (mm)	Acceptable Qty		A	B	$\Phi \leq 0.1$	Ignore		$0.15 < \Phi \leq 0.2$	3(distance ≥ 10 mm)		$0.2 < \Phi \leq 0.25$	2		$\Phi > 0.25$	0		Assembly deflection	beyond the edge of backlight ≤ 0.2 mm		
		CTP Cover sensor accidented black/white spot		<table border="1"> <thead> <tr> <th rowspan="2">Size Φ(mm)</th> <th colspan="3">Acceptable Qty</th> </tr> <tr> <th>A</th> <th>B</th> <th>C</th> </tr> </thead> <tbody> <tr> <td>$\Phi \leq 0.1$</td> <td colspan="3">Ignore</td> </tr> <tr> <td>$0.15 < \Phi \leq 0.25$</td> <td colspan="3">4 (distance ≥ 10mm)</td> </tr> <tr> <td>$0.25 < \Phi \leq 0.35$</td> <td colspan="3">3</td> </tr> <tr> <td>$\Phi > 0.4$</td> <td colspan="3">1</td> </tr> </tbody> </table>		Size Φ (mm)	Acceptable Qty			A	B	C	$\Phi \leq 0.1$	Ignore			$0.15 < \Phi \leq 0.25$	4 (distance ≥ 10 mm)			$0.25 < \Phi \leq 0.35$	3			$\Phi > 0.4$	1																																																																														
				Size Φ (mm)	Acceptable Qty																																																																																																			
					A	B	C																																																																																																	
				$\Phi \leq 0.1$	Ignore																																																																																																			
$0.15 < \Phi \leq 0.25$	4 (distance ≥ 10 mm)																																																																																																							
$0.25 < \Phi \leq 0.35$	3																																																																																																							
$\Phi > 0.4$	1																																																																																																							
<table border="1"> <thead> <tr> <th rowspan="2">Width(mm)</th> <th rowspan="2">Ignore(mm)</th> <th colspan="3">Acceptable Qty</th> </tr> <tr> <th>A</th> <th>B</th> <th>C</th> </tr> </thead> <tbody> <tr> <td>$\Phi \leq 0.05$</td> <td>Ignore</td> <td colspan="3">Ignore</td> </tr> <tr> <td>$0.05 < W \leq 0.06$</td> <td>$L \leq 4.0$</td> <td colspan="3">$N \leq 3$</td> </tr> <tr> <td>$0.07 < W \leq 0.08$</td> <td>$L \leq 3.0$</td> <td colspan="3">$N \leq 2$</td> </tr> <tr> <td>$0.08 < W$</td> <td colspan="4">Define as spot defect</td> </tr> </tbody> </table>	Width(mm)	Ignore(mm)	Acceptable Qty			A	B	C	$\Phi \leq 0.05$	Ignore	Ignore			$0.05 < W \leq 0.06$	$L \leq 4.0$	$N \leq 3$			$0.07 < W \leq 0.08$	$L \leq 3.0$	$N \leq 2$			$0.08 < W$	Define as spot defect																																																																															
Width(mm)			Ignore(mm)	Acceptable Qty																																																																																																				
	A	B		C																																																																																																				
$\Phi \leq 0.05$	Ignore	Ignore																																																																																																						
$0.05 < W \leq 0.06$	$L \leq 4.0$	$N \leq 3$																																																																																																						
$0.07 < W \leq 0.08$	$L \leq 3.0$	$N \leq 2$																																																																																																						
$0.08 < W$	Define as spot defect																																																																																																							
<table border="1"> <thead> <tr> <th rowspan="2">Zone Size (mm)</th> <th colspan="3">Acceptable Qty</th> </tr> <tr> <th colspan="3">C</th> </tr> </thead> <tbody> <tr> <td>$\Phi \leq 0.2$</td> <td colspan="3">Ignore</td> </tr> <tr> <td>$0.2 < \Phi \leq 0.3$</td> <td colspan="3">4(distance ≥ 10mm)</td> </tr> <tr> <td>$0.3 < \Phi \leq 0.4$</td> <td colspan="3">3</td> </tr> <tr> <td>$\Phi > 0.4$</td> <td colspan="3">0</td> </tr> </tbody> </table>	Zone Size (mm)	Acceptable Qty			C			$\Phi \leq 0.2$	Ignore			$0.2 < \Phi \leq 0.3$	4(distance ≥ 10 mm)			$0.3 < \Phi \leq 0.4$	3			$\Phi > 0.4$	0																																																																																			
Zone Size (mm)		Acceptable Qty																																																																																																						
	C																																																																																																							
$\Phi \leq 0.2$	Ignore																																																																																																							
$0.2 < \Phi \leq 0.3$	4(distance ≥ 10 mm)																																																																																																							
$0.3 < \Phi \leq 0.4$	3																																																																																																							
$\Phi > 0.4$	0																																																																																																							
<table border="1"> <tr> <td rowspan="5">CTP Bonding bubble/ accidented spot</td> <td> <table border="1"> <thead> <tr> <th rowspan="2">Size Φ(mm)</th> <th colspan="2">Acceptable Qty</th> </tr> <tr> <th>A</th> <th>B</th> </tr> </thead> <tbody> <tr> <td>$\Phi \leq 0.1$</td> <td colspan="2">Ignore</td> </tr> <tr> <td>$0.15 < \Phi \leq 0.2$</td> <td colspan="2">3(distance ≥ 10mm)</td> </tr> <tr> <td>$0.2 < \Phi \leq 0.25$</td> <td colspan="2">2</td> </tr> <tr> <td>$\Phi > 0.25$</td> <td colspan="2">0</td> </tr> </tbody> </table> </td> </tr> <tr> <td>Assembly deflection</td> <td colspan="3">beyond the edge of backlight ≤ 0.2mm</td> </tr> </table>	CTP Bonding bubble/ accidented spot	<table border="1"> <thead> <tr> <th rowspan="2">Size Φ(mm)</th> <th colspan="2">Acceptable Qty</th> </tr> <tr> <th>A</th> <th>B</th> </tr> </thead> <tbody> <tr> <td>$\Phi \leq 0.1$</td> <td colspan="2">Ignore</td> </tr> <tr> <td>$0.15 < \Phi \leq 0.2$</td> <td colspan="2">3(distance ≥ 10mm)</td> </tr> <tr> <td>$0.2 < \Phi \leq 0.25$</td> <td colspan="2">2</td> </tr> <tr> <td>$\Phi > 0.25$</td> <td colspan="2">0</td> </tr> </tbody> </table>	Size Φ (mm)	Acceptable Qty		A	B	$\Phi \leq 0.1$	Ignore		$0.15 < \Phi \leq 0.2$	3(distance ≥ 10 mm)		$0.2 < \Phi \leq 0.25$	2		$\Phi > 0.25$	0		Assembly deflection	beyond the edge of backlight ≤ 0.2 mm																																																																																			
CTP Bonding bubble/ accidented spot		<table border="1"> <thead> <tr> <th rowspan="2">Size Φ(mm)</th> <th colspan="2">Acceptable Qty</th> </tr> <tr> <th>A</th> <th>B</th> </tr> </thead> <tbody> <tr> <td>$\Phi \leq 0.1$</td> <td colspan="2">Ignore</td> </tr> <tr> <td>$0.15 < \Phi \leq 0.2$</td> <td colspan="2">3(distance ≥ 10mm)</td> </tr> <tr> <td>$0.2 < \Phi \leq 0.25$</td> <td colspan="2">2</td> </tr> <tr> <td>$\Phi > 0.25$</td> <td colspan="2">0</td> </tr> </tbody> </table>		Size Φ (mm)	Acceptable Qty		A	B	$\Phi \leq 0.1$	Ignore		$0.15 < \Phi \leq 0.2$	3(distance ≥ 10 mm)		$0.2 < \Phi \leq 0.25$	2		$\Phi > 0.25$	0																																																																																					
		Size Φ (mm)	Acceptable Qty																																																																																																					
			A	B																																																																																																				
		$\Phi \leq 0.1$	Ignore																																																																																																					
	$0.15 < \Phi \leq 0.2$	3(distance ≥ 10 mm)																																																																																																						
$0.2 < \Phi \leq 0.25$	2																																																																																																							
$\Phi > 0.25$	0																																																																																																							
Assembly deflection	beyond the edge of backlight ≤ 0.2 mm																																																																																																							

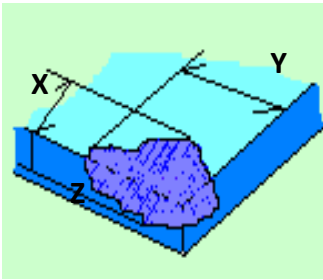
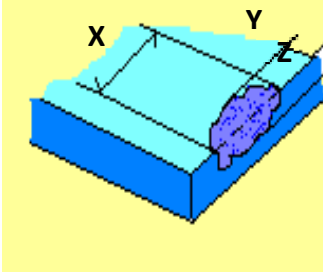
		TP cover broken X : length Y : width Z : height	<table border="1"> <tr> <td>X</td> <td>Y</td> <td>Z</td> </tr> <tr> <td>$X \leq 0.5\text{mm}$</td> <td>$Y \leq 0.5\text{mm}$</td> <td>$Z < \text{cover thickness}$</td> </tr> </table> <p>*Circuitry broken is not allowed.</p>	X	Y	Z	$X \leq 0.5\text{mm}$	$Y \leq 0.5\text{mm}$	$Z < \text{cover thickness}$	
X	Y	Z								
$X \leq 0.5\text{mm}$	$Y \leq 0.5\text{mm}$	$Z < \text{cover thickness}$								
		TP cover broken X : length Y : width Z : height	<table border="1"> <tr> <td>X</td> <td>Y</td> <td>Z</td> </tr> <tr> <td>$X \leq 0.3\text{mm}$</td> <td>$Y \leq 0.3\text{mm}$</td> <td>$Z < \text{LCD thickness}$</td> </tr> </table> <p>* Circuitry broken is not allowed.</p>	X	Y	Z	$X \leq 0.3\text{mm}$	$Y \leq 0.3\text{mm}$	$Z < \text{LCD thickness}$	
X	Y	Z								
$X \leq 0.3\text{mm}$	$Y \leq 0.3\text{mm}$	$Z < \text{LCD thickness}$								

Criteria (functional items)

Number	Items	Criteria (mm)
1	No display	Not allowed
2	Missing segment	Not allowed
3	Short	Not allowed
4	Backlight no lighting	Not allowed
5	TP no function	Not allowed

6.1.7 Classification of Defects

Visual defects (except no or wrong label) are treated as minor defects, while electrical defects are treated as major defects.

Two minor defects are equal to one major defect in lot sampling inspection.

6.1.8 Identification / marking criteria

Any unit with illegible / wrong / double or no marking / label shall be rejected.



6.2 Dealing with Customer Complaints

6.2.1 Non-conforming analysis

Purchaser should supply Densitron with detailed data of non-conforming sample. After accepting it, Densitron should complete the analysis in two weeks from receiving the sample.

If the analysis cannot be completed on time, Densitron must inform the purchaser.

6.2.2 Handling of non-conforming displays

If any non-conforming displays are found during customer acceptance inspection which Densitron is clearly responsible for, return them to Densitron.

Both Densitron and customer should analyse the reason and discuss the handling of non-conforming displays when the reason is not clear.

Equally, both sides should discuss and come to agreement for issues pertaining to modification of Densitron quality assurance standard.

7.0 Reliability Specification

7.1 Reliability Tests

Test Item		Test Condition		Sample Size
Durability Test	High Temperature Operation	Ta= 70°C	96h	3pcs
	Low Temperature Operation	Ta=-20°C	96h	3pcs
	Temperature Cycle Operation	-20°C ↔ 70°C ON/OFF, 20 cycles. ON time over 10 seconds, OFF time over 10 seconds		3pcs
	High Temperature Storage	Tp= 80°C	96h	3pcs
	Low Temperature Storage	Tp= -30°C	96h	3pcs
	ESD Test	150pF, 330Ω, ±6KV (Contact)/±8KV (Air), 5 Points/panel, 10 times/point		3pcs
	Thermal Shock Resistance	The sample should be allowed to stand the following 5 cycles of operation: LTS for 30 minutes -> normal temperature for 5 minutes -> HTS for 30 minutes -> normal temperature for 5 minutes, as one cycle, then taking it out and drying it at normal temperature, and allowing it stand for 24 hours		3pcs
	Box Drop Test	1 Corner 3 Edges 6 faces, 66 cm (Medium Box)		1 box

Note: Ta=ambient temperature Tp= Panel temperature

Notes:

1. No dew condensation to be observed.
2. The function test shall be conducted after 4 hours storage at the normal temperature and humidity after removed from the test chamber.
3. No cosmetic or functional defects should be allowed.
4. Total current consumption should be less than twice the initial value.



8.0 Handling Precautions

Safety

If the LCD panel breaks, be careful not to get the liquid crystal fluid in your mouth or in your eyes.

If the liquid crystal touches your skin or clothes, wash it off immediately using soap and plenty of water.

Mounting and Design

Place a transparent plate (e.g. acrylic, polycarbonate or glass) on the display surface to protect the display from external pressure. Leave a small gap between the transparent plate and the display surface.

When assembling with a zebra connector, clean the surface of the pads with alcohol and keep the surrounding air very clean.

Design the system so that no input signal is given unless the power supply voltage is applied.

Caution during LCD cleaning

Lightly wipe the display surface with a soft cloth soaked with Isopropyl alcohol, Ethyl alcohol or Trichlorotrifluoroethane.

Do not wipe the display surface with dry or hard materials that will damage the polariser surface.

Do not use aromatic solvents (toluene and xylene), or ketonic solvents (ketone and acetone).

Caution against static charge

As the display uses C-MOS LSI drivers, connect any unused input terminal to VDD or VSS. Do not input any signals before power is turned on. Also, ground your body, work/assembly table and assembly equipment to protect against static electricity.

Packaging

Displays use LCD elements, and must be treated as such. Avoid strong shock and drop from a height.

To prevent displays from degradation, do not operate or store them exposed directly to sunshine or high temperature/humidity.

Caution during operation

It is indispensable to drive the display within the specified voltage limit since excessive voltage shortens its life. Direct current causes an electrochemical reaction with remarkable deterioration of the display quality. Give careful consideration to prevent direct current during ON/OFF timing and during operation. Response time is extremely delayed at temperatures lower than the operating temperature range while, at high temperatures, displays become dark. However, this phenomenon is reversible and does not mean a malfunction or a display that has been permanently damaged. If the display area is pushed on hard during operation, some graphics will be abnormally displayed but returns to a normal condition after turning off the display once. Even a small amount of condensation on the contact pads (terminals) can cause an electro-chemical reaction which causes missing rows and columns. Give careful attention to avoid condensation.

Storage

Store the display in a dark place where the temperature is $25^{\circ}\text{C} \pm 10^{\circ}\text{C}$ and the humidity below 50%RH. Store the display in a clean environment, free from dust, organic solvents and corrosive gases. Do not crash, shake or jolt the display (including accessories).