

## OMNIMATE Signal - series B2C/S2C 3.50 - 2-row S2C-SMT 3.50/08/180LF 3.5SN BK BX

**Weidmüller Interface GmbH & Co. KG**  
Klingenbergstraße 16  
D-32758 Detmold  
Germany  
Fon: +49 5231 14-0  
Fax: +49 5231 14-292083  
www.weidmueller.com



### High-temperature-resistant pin header.

- touch-safe
- can be plugged into B2CF 3.50 PUSH IN female plug
- Plug-in direction is perpendicular or parallel to the circuit board (180° / 90°)
- Housing variants: closed (G) and with solder flange (LF)
- Box packaging (BX) or, anti-static, tape-on-reel (RL)
- Suitable for reflow and wave soldering applications
- Pin length of either 1.5 mm or 3.5 mm

### General ordering data

Type	S2C-SMT 3.50/08/180LF 3.5SN BK BX
Order No.	<a href="#">1290240000</a>
Version	PCB plug-in connector, male header, Solder flange, THT/THR solder connection, 3.50 mm, No. of poles: 8, 180°, Solder pin length (l): 3.5 mm, tinned, Black, Box
GTIN (EAN)	4050118083569
Qty.	84 pc(s).
Product data	IEC: 200 V / 13.4 A UL: 150 V / 10 A
Packaging	Box

**OMNIMATE Signal - series B2C/S2C 3.50 - 2-row  
S2C-SMT 3.50/08/180LF 3.5SN BK BX**

**Weidmüller Interface GmbH & Co. KG**  
 Klingenbergstraße 16  
 D-32758 Detmold  
 Germany  
 Fon: +49 5231 14-0  
 Fax: +49 5231 14-292083  
 www.weidmueller.com

**Technical data****Dimensions and weights**

Width	17.6 mm	Width (inches)	0.693 inch
Height	17.7 mm	Height (inches)	0.697 inch
Height of lowest version	14.2 mm	Depth	10.8 mm
Depth (inches)	0.425 inch	Net weight	3.22 g

**System specifications**

Product family	OMNIMATE Signal - series B2C/S2C 3.50 - 2-row	Type of connection	Board connection
Mounting onto the PCB	THT/THR solder connection	Pitch in mm (P)	3.5 mm
Pitch in inches (P)	0.138 inch	Outgoing elbow	180°
No. of poles	8	Number of solder pins per pole	1
Solder pin length (l)	3.5 mm	Solder pin length tolerance	0 / -0.3 mm
Tolerance of solder pin position	± 0.1 mm	Solder pin dimensions	d = 1.0 mm, Octagonal
Solder pin dimensions = d tolerance	+0,01 / -0,03 mm	Solder eyelet hole diameter (D)	1.3 mm
Solder eyelet hole diameter tolerance (D)	+ 0,1 mm	Outside diameter of solder pad	2.1 mm
Template aperture diameter	1.9 mm	L1 in mm	10.5 mm
L1 in inches	0.413 inch	Number of rows	1
Pin series quantity	2	Touch-safe protection acc. to DIN VDE 57 106	Safe from finger touch
Touch-safe protection acc. to DIN VDE 0470	IP 20	Can be coded	Yes
Plugging cycles	25	push-in force/pole	5 N
Withdrawal force per pole	5 N	Packaging	Box

**Material data**

Insulating material	LCP GF	Colour	Black
Colour chart (similar)	RAL 9011	Insulating material group	IIIb
CTI	≥ 175	Insulation resistance	≥ 10 <sup>8</sup> Ω
Moisture Level (MSL)	1	UL 94 flammability rating	V-0
Contact material	Copper alloy	Contact surface	tinned
Layer structure of solder connection	2-5 µm Sn / 1-3 µm Ni	Layer structure of plug contact	2-5 µm Sn / 1-3 µm Ni
Storage temperature, min.	-25 °C	Storage temperature, max.	55 °C
Max. relative humidity during storage	80 %	Operating temperature, min.	-50 °C
Operating temperature, max.	120 °C	Temperature range, installation, min.	-40 °C
Temperature range, installation, max.	120 °C		

**Rated data acc. to IEC**

tested acc. to standard	IEC 60664-1, IEC 61984	Rated current, min. no. of poles (Tu=20°C)	13.4 A
Rated current, min. no. of poles (Tu=40°C)	12 A	Rated voltage for surge voltage class / pollution degree II/2	200 V
Rated voltage for surge voltage class / pollution degree III/2	160 V	Rated voltage for surge voltage class / pollution degree III/3	80 V
Rated impulse voltage for surge voltage class/ pollution degree II/2	2.5 kV	Rated impulse voltage for surge voltage class/ pollution degree III/2	2.5 kV
Rated impulse voltage for surge voltage class/ contamination degree III/3	2.5 kV	Short-time withstand current resistance	3 x 1s with 80 A

## OMNIMATE Signal - series B2C/S2C 3.50 - 2-row S2C-SMT 3.50/08/180LF 3.5SN BK BX

**Weidmüller Interface GmbH & Co. KG**  
 Klingenbergstraße 16  
 D-32758 Detmold  
 Germany  
 Fon: +49 5231 14-0  
 Fax: +49 5231 14-292083  
 www.weidmueller.com

### Technical data

#### Rated data acc. to CSA

Institute (CSA)		Certificate No. (CSA)	200039-1121690
Rated voltage (Use group B)	150 V	Rated voltage (Use group C)	50 V
Rated voltage (use group D)	150 V	Rated current (use group B)	9.5 A
Rated current (use group C)	9.5 A	Rated current (use group D)	9.5 A
Reference to approval values	Specifications are maximum values, details - see approval certificate.		

#### Rated data acc. to UL 1059

Institute (cURus)		Certificate No. (cURus)	E60693
Rated voltage (use group B)	150 V	Rated voltage (use group C)	50 V
Rated current (use group B)	10 A	Rated current (use group C)	10 A
Reference to approval values	Specifications are maximum values, details - see approval certificate.		

#### Classifications

ETIM 4.0	EC002637	ETIM 5.0	EC002637
ETIM 6.0	EC002637	eClass 6.2	27-26-07-04
eClass 7.1	27-44-04-02	eClass 8.1	27-44-04-02
eClass 9.0	27-44-04-02	eClass 9.1	27-44-04-02

#### Notes

Notes	<ul style="list-style-type: none"> <li>• Gold-plated contact surfaces on request</li> <li>• Rated current related to rated cross-section &amp; min. No. of poles.</li> <li>• Spacing between rows: see hole layout</li> <li>• P on drawing = pitch</li> <li>• Rated data refer only to the component itself. Clearance and creepage distances to other components are to be designed in accordance with the relevant application standards.</li> </ul>
IPC conformity	Conformity: The products are developed, manufactured and delivered according international recognized standards and norms and comply with the assured properties in the data sheet resp. fulfill decorative properties in accordance with IPC-A-610 "Class 2". Further claims on the products can be evaluated on request.

#### Approvals

Approvals	
ROHS	Conform

**Data sheet****OMNIMATE Signal - series B2C/S2C 3.50 - 2-row  
S2C-SMT 3.50/08/180LF 3.5SN BK BX**

**Weidmüller Interface GmbH & Co. KG**  
Klingenbergstraße 16  
D-32758 Detmold  
Germany  
Fon: +49 5231 14-0  
Fax: +49 5231 14-292083  
www.weidmueller.com

**Technical data****Downloads**

Approval/Certificate/Document of Conformity	<a href="#">Declaration of the Manufacturer</a>
Brochure/Catalogue	<a href="#">FL DRIVES EN</a> <a href="#">MB SMT EN</a> <a href="#">FL DRIVES DE</a> <a href="#">MB DEVICE MANUF. EN</a> <a href="#">CAT 2 PORTFOLIOGUIDE EN</a> <a href="#">FL BUILDING SAFETY EN</a> <a href="#">FL APPL LED LIGHTING EN</a> <a href="#">FL INDUSTR.CONTROLS EN</a> <a href="#">FL MACHINE SAFETY EN</a> <a href="#">FL HEATING ELECTR EN</a> <a href="#">FL APPL INVERTER EN</a> <a href="#">FL_BASE_STATION_EN</a> <a href="#">FL ELEVATOR EN</a> <a href="#">FL POWER SUPPLY EN</a> <a href="#">FL 72H SAMPLE SER EN</a> <a href="#">PO OMNIMATE EN</a>
Engineering Data	<a href="#">EPLAN, WSCAD</a>
SMT white paper	<a href="#">Download Whitepaper</a>

**Data sheet**

**OMNIMATE Signal - series B2C/S2C 3.50 - 2-row  
S2C-SMT 3.50/08/180LF 3.5SN BK BX**

**Weidmüller Interface GmbH & Co. KG**  
 Klingenbergstraße 16  
 D-32758 Detmold  
 Germany  
 Fon: +49 5231 14-0  
 Fax: +49 5231 14-292083  
 www.weidmueller.com

**Drawings**

**Dimensional drawing**

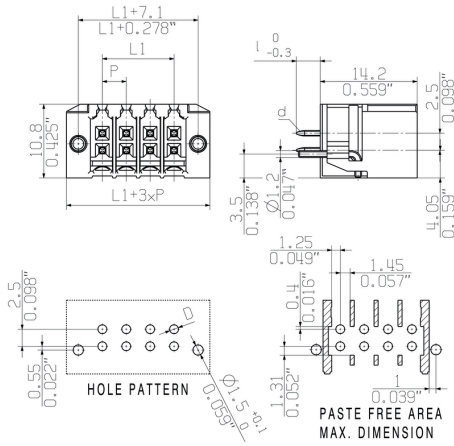

## Recommended wave soldering profiles

**Weidmüller Interface GmbH & Co. KG**  
 Klingenbergstraße 16  
 D-32758 Detmold  
 Germany  
 Fon: +49 5231 14-0  
 Fax: +49 5231 14-292083  
 www.weidmueller.com

### Single Wave:



### Double Wave:



### Wave soldering profiles

Wired connection elements should be processed in accordance with the DIN EN 61760-1 standard. We have included two recommendations for practical wave soldering profiles, with which Weidmüller PCB terminals and connectors are qualified.

When choosing a suitable profile for your application, the following factors also need to be considered:

- PCB thickness
- Proportion of Cu in the layers
- Single/double-sided assembly
- Product range
- Heating and cooling rates

The single and double wave profiles each indicate the recommended operating range, including the maximum soldering temperature of 260°C. In practice, the maximum soldering temperature is quite often well below the above maximum profile.

## Recommended reflow soldering profile

**Weidmüller Interface GmbH & Co. KG**  
 Klingenbergstraße 16  
 D-32758 Detmold  
 Germany  
 Fon: +49 5231 14-0  
 Fax: +49 5231 14-292083  
 www.weidmueller.com



### Reflow soldering profile

The perfect soldering profile for SMT Surface Mount Technology is one the most exiting question in SMT production. But there are more than one correct answer: The diagram of temperature-on-time is related to processing features of solder paste and to maximum load of components.

We have to consider the following parameters:

- Time for pre heating
- Maximum temperature
- Time above melting point
- Time for cooling
- Maximum heating rate
- Maximum cooling rate

We recommend a typical solder profile with associated process limits. With preheating components and board are prepared smoothly for the solder phase. Heating rate is typically  $\leq +3\text{K/s}$ . In parallel the solder paste is ‚activated‘. The time above melting point of 217°C the paste gets liquid and components and boards begin to connect. The maximum temperature of 245°C to 254°C should stay between 10 and 40 seconds. In the cooling phase at  $\geq -6\text{K/s}$  solder is cured. Board and components cool down while avoiding cold cracks.