

2x2 4G/LTE MIMO Antenna

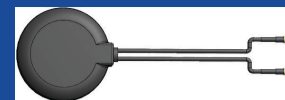

AEACBA081014-M698



Ø81.6 x 14.5 mm
RoHS/RoHS II Compliant

MSL - N/A

FEATURES

- Covers 4G/LTE
- Operates in 698-2700 MHz
- IP67 rated
- Linear polarization
- Gain of 3.0 dBi
- Adhesive mounting

APPLICATIONS

- 4G/LTE
- Telematics
- Fleet monitoring
- IoT
- Video, Surveillance
- Femtocells
- M2M

Electrical Specifications

Parameters	Min	Typ.	Max.	Units	Note
Frequency Range		698-960/1710-2690		MHz	
VSWR			3.0		
Polarization Model	Linear				
Impedance		50		Ω	
Gain Main		3		dBi	Zenith
Gain AUX		3		dBi	Zenith

Mechanical Characteristics

Parameters	Description
Connector	2xSMA Male
Cable Type	2xRG174
Cable Length	2x2M
Material	ABS
Mount way	Adhesive
Dimensions	Φ81.6x14.5mm

2x2 4G/LTE MIMO Antenna



AEACBA081014-M698



Ø81.6 x 14.5 mm
RoHS/RoHS II Compliant

MSL - N/A

Environmental Characteristics

Parameters	Description
Waterproof	IP67
Operating Temperature	-40 ~ +85 °C
Relative Humidity	Up to 95%
MSL Level	N/A
ROHS Compliant	Yes
Vibration	10 to 55Hz with 1.5mm amplitude 2 hours

Dimensions

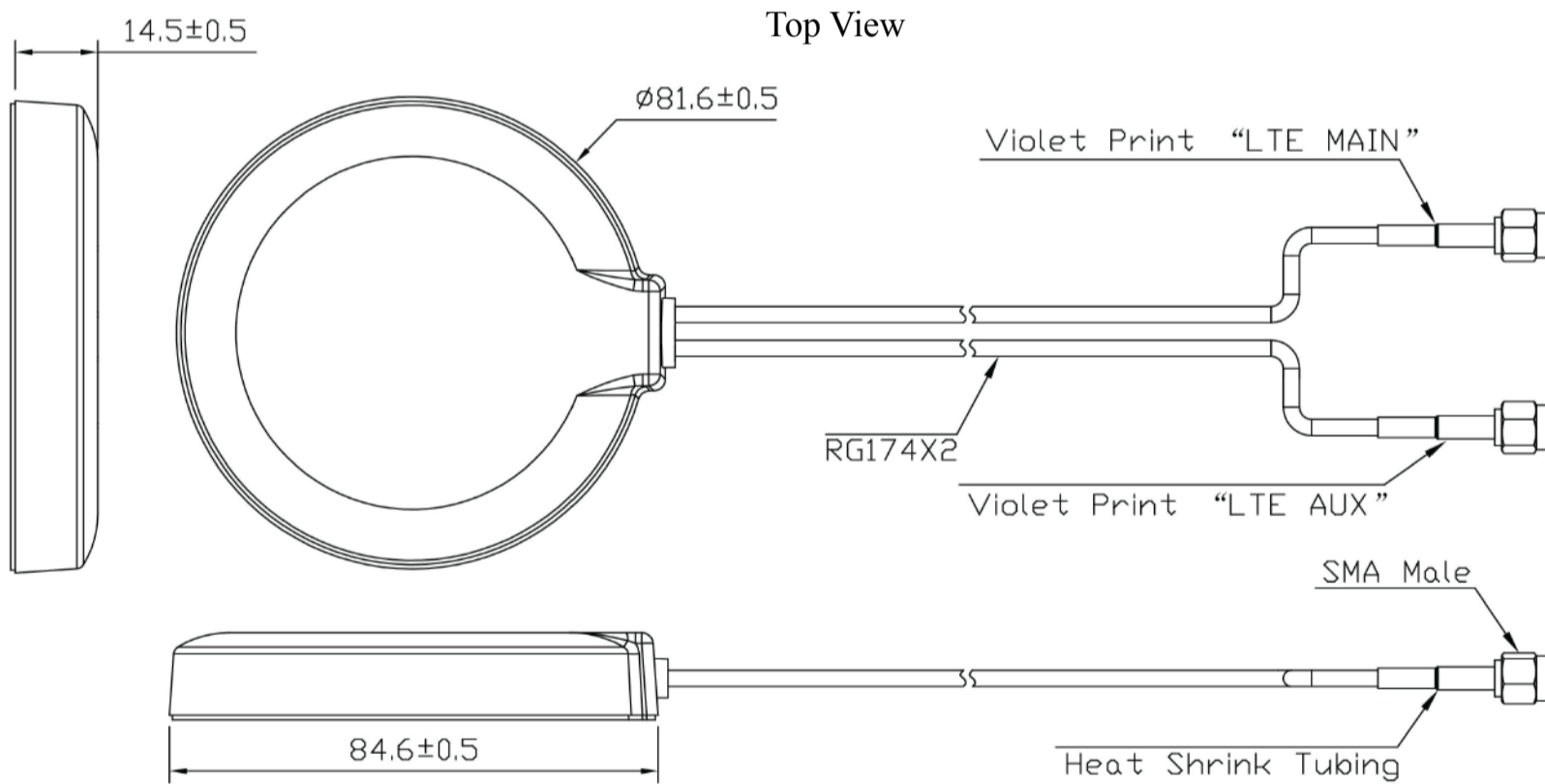

Unit:mm

2x2 4G/LTE MIMO Antenna



AEACBA081014-M698



Ø81.6 x 14.5 mm
RoHS/RoHS II Compliant

MSL - N/A

Product Image



VSWR Characteristics

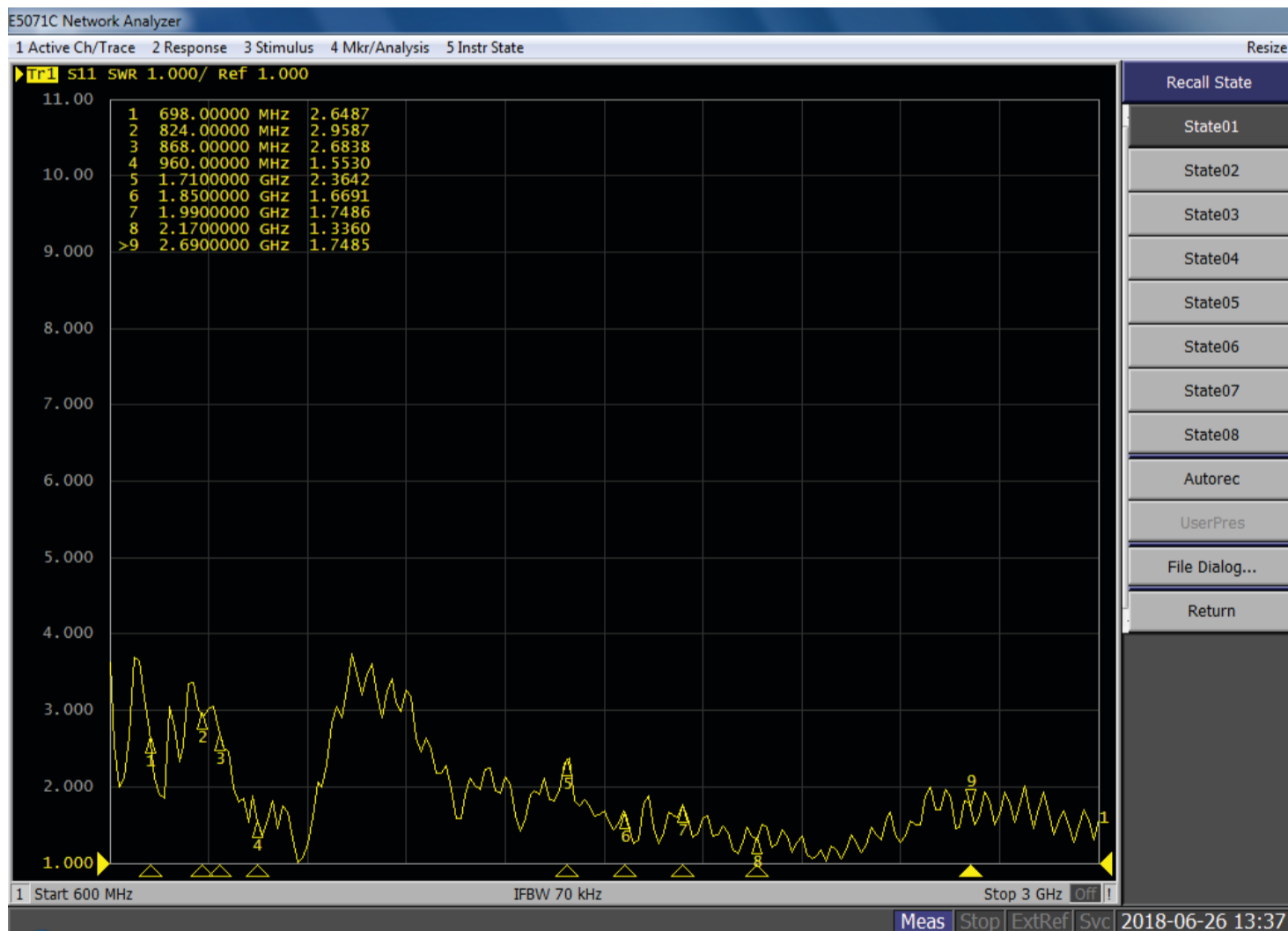

2x2 4G/LTE MIMO Antenna

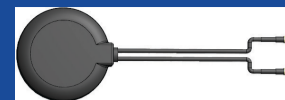

AEACBA081014-M698



Ø81.6 x 14.5 mm
RoHS/RoHS II Compliant

MSL - N/A

Gain and Efficiency

Frequency (MHz)	Efficiency	Gain (dBi)
700	0.62	2.23
824	0.68	3.0
868	0.62	1.12
960	0.66	1.0
1710	0.61	0.9
1850	0.65	0.3
1990	0.63	0.73
2170	0.64	1.96
2690	0.65	1.94

Radiation Patterns



2x2 4G/LTE MIMO Antenna



AEACBA081014-M698



Ø81.6 x 14.5 mm
RoHS/RoHS II Compliant

MSL - N/A

Radiation Patterns

2D Radiation Patterns
LTE Antenna MAIN

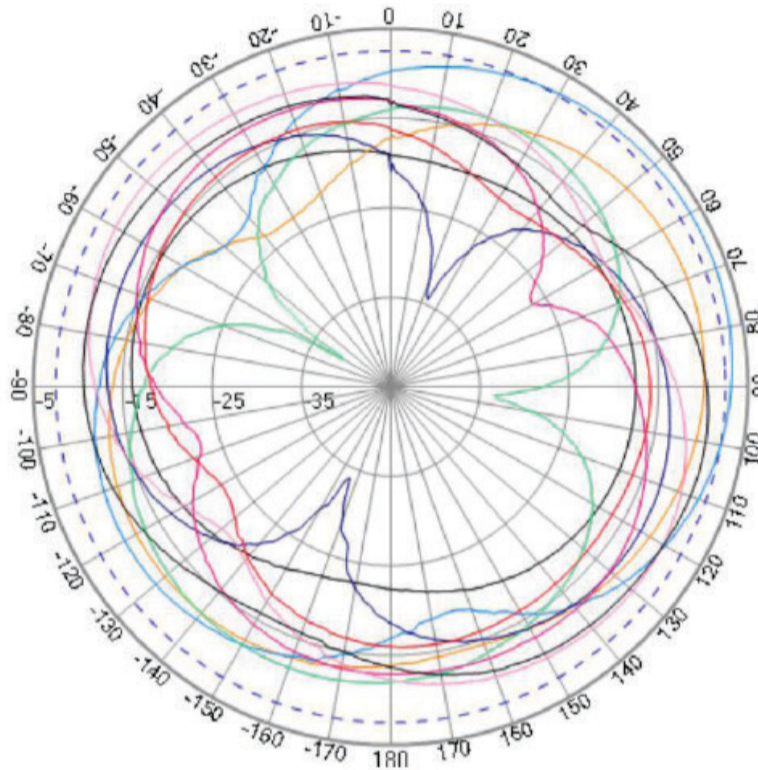

XY PLANE

- Freq: 700
- Freq: 824
- Freq: 868
- Freq: 960
- Freq: 1710
- Freq: 1850
- Freq: 1990
- Freq: 2170
- Freq: 2690

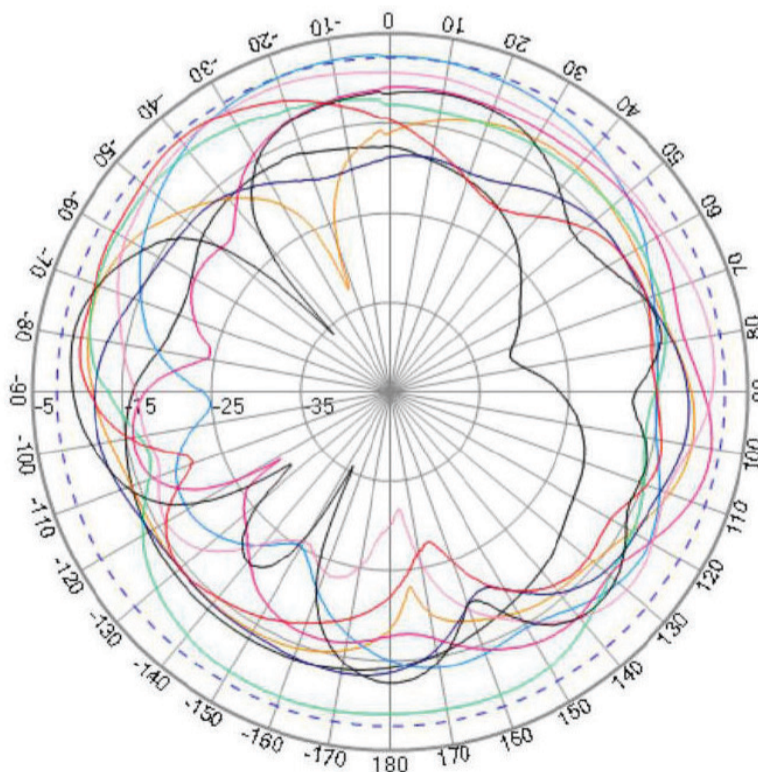

XZ PLANE

- Freq: 700
- Freq: 824
- Freq: 868
- Freq: 960
- Freq: 1710
- Freq: 1850
- Freq: 1990
- Freq: 2170
- Freq: 2690



5101 Hidden Creek Ln Spicewood TX 78669
Phone: 512-371-6159 | Fax: 512-351-8858
For terms and conditions of sales, please visit:
www.abracon.com

REVISED: 08.15.2018

ABRACON IS
ISO9001-2015
CERTIFIED

2x2 4G/LTE MIMO Antenna



AEACBA081014-M698



Ø81.6 x 14.5 mm
RoHS/RoHS II Compliant

MSL - N/A

Radiation Patterns

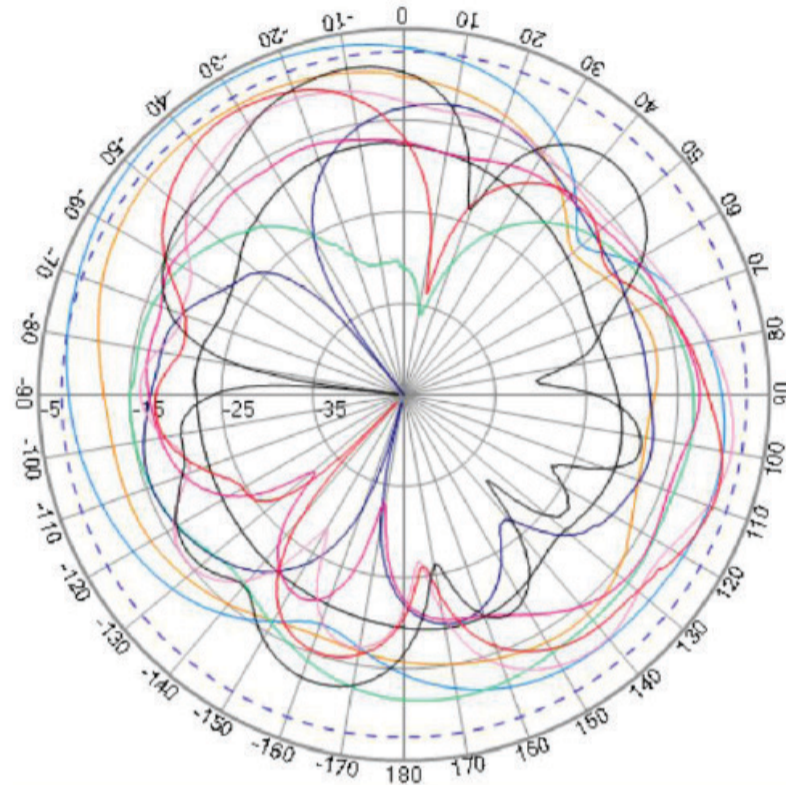

YZ PLANE

- Freq: 700
- Freq: 824
- Freq: 868
- Freq: 960
- Freq: 1710
- Freq: 1850
- Freq: 1990
- Freq: 2170
- Freq: 2690

LTE Antenna AUX

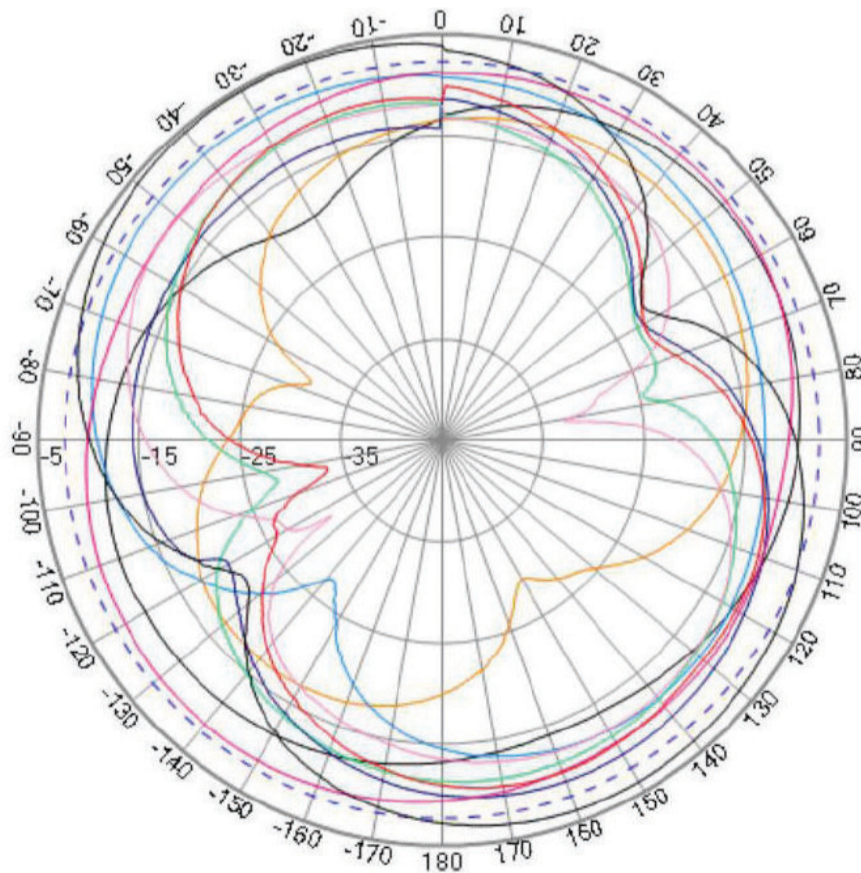

XY PLANE

- Freq: 700
- Freq: 824
- Freq: 868
- Freq: 960
- Freq: 1710
- Freq: 1850
- Freq: 1990
- Freq: 2170
- Freq: 2690



5101 Hidden Creek Ln Spicewood TX 78669
Phone: 512-371-6159 | Fax: 512-351-8858
For terms and conditions of sales, please visit:
www.abracon.com

REVISED: 08.15.2018

ABRACON IS
ISO9001-2015
CERTIFIED

2x2 4G/LTE MIMO Antenna



AEACBA081014-M698



Ø81.6 x 14.5 mm
RoHS/RoHS II Compliant

MSL - N/A

Radiation Patterns

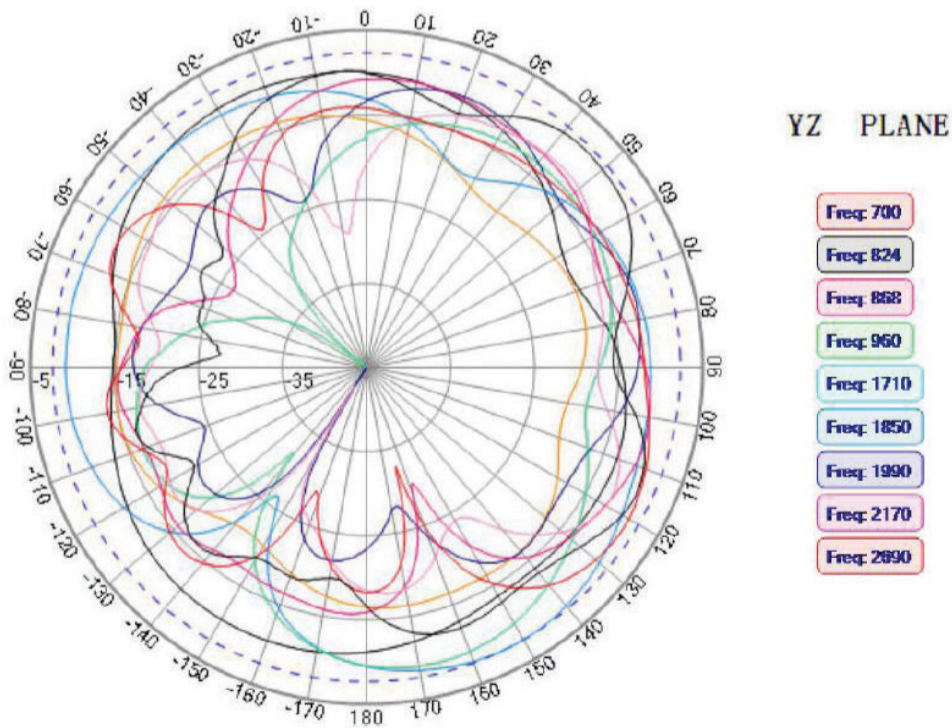
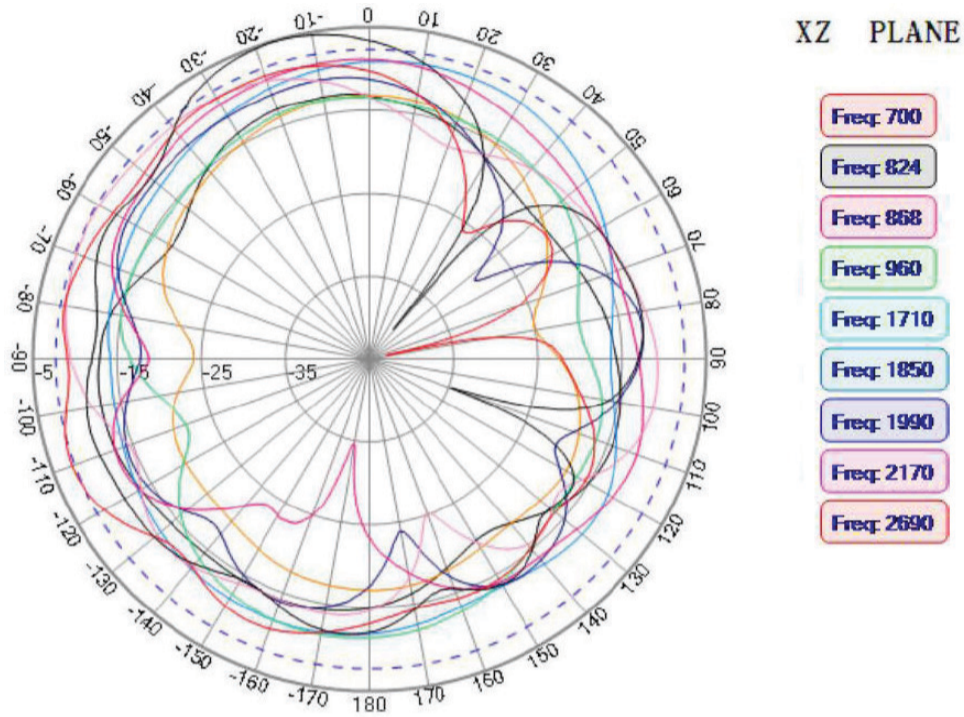

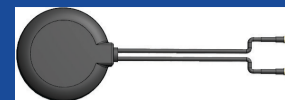

AEACBA081014-M698



Ø81.6 x 14.5 mm
RoHS/RoHS II Compliant

MSL - N/A

3D Radiation Patterns

700 MHz

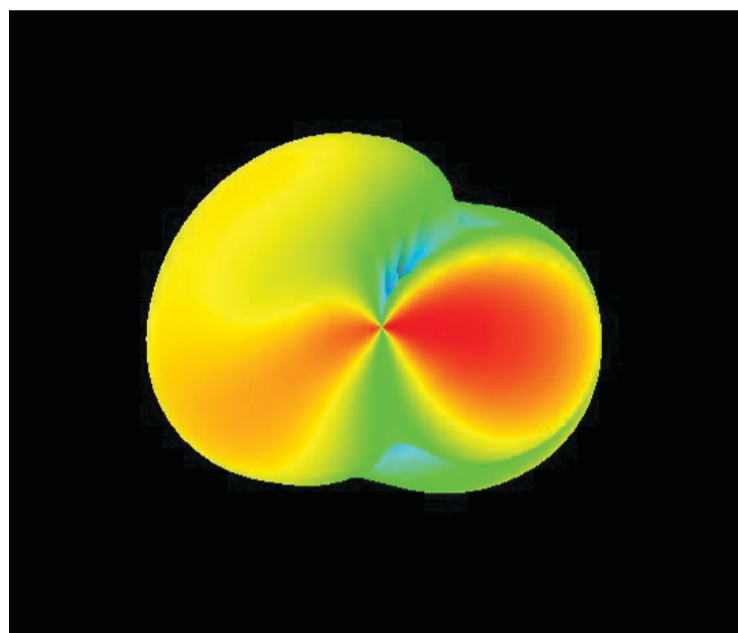

824 MHz

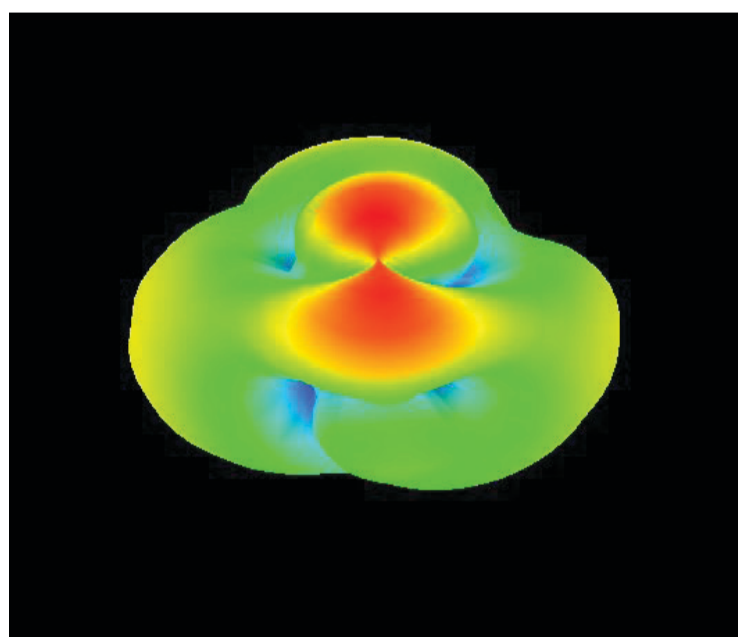

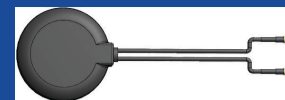

AEACBA081014-M698



Ø81.6 x 14.5 mm
RoHS/RoHS II Compliant

MSL - N/A

3D Radiation Patterns

868 MHz

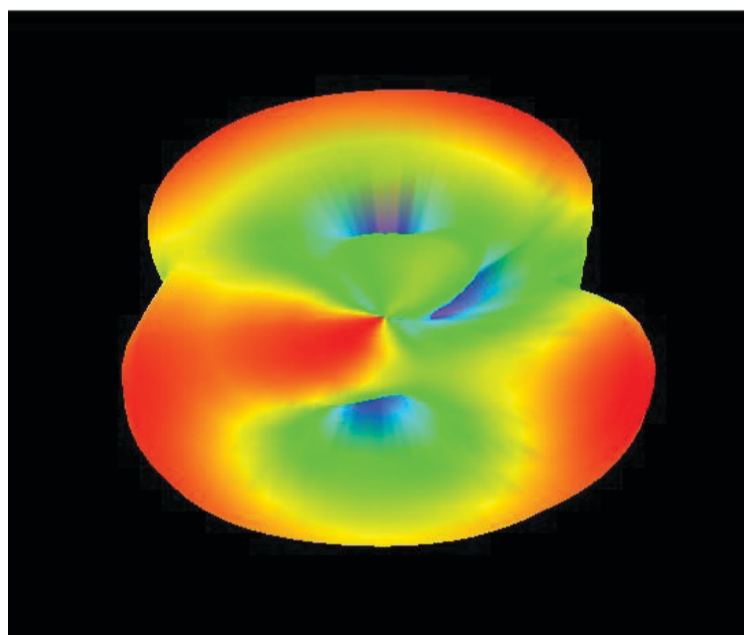

960 MHz

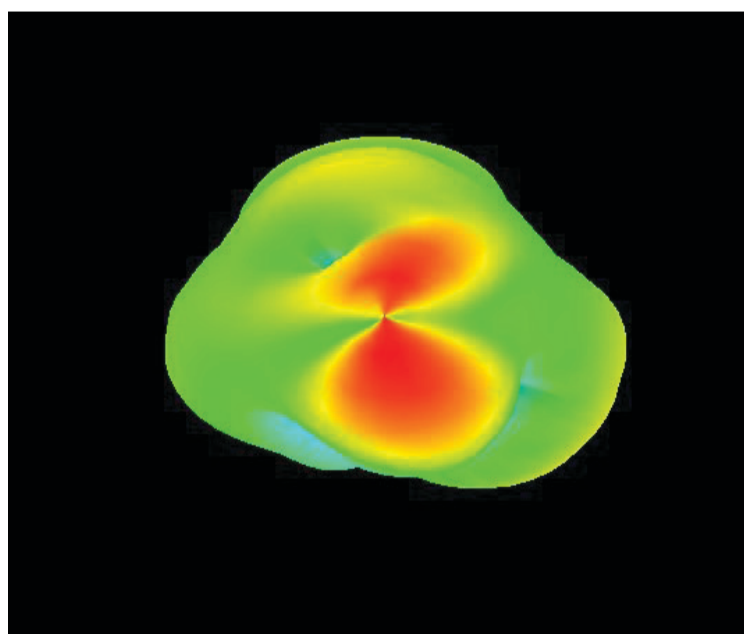

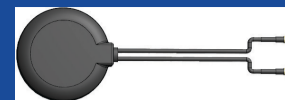

AEACBA081014-M698



Ø81.6 x 14.5 mm
RoHS/RoHS II Compliant

MSL - N/A

3D Radiation Patterns

1710 MHz

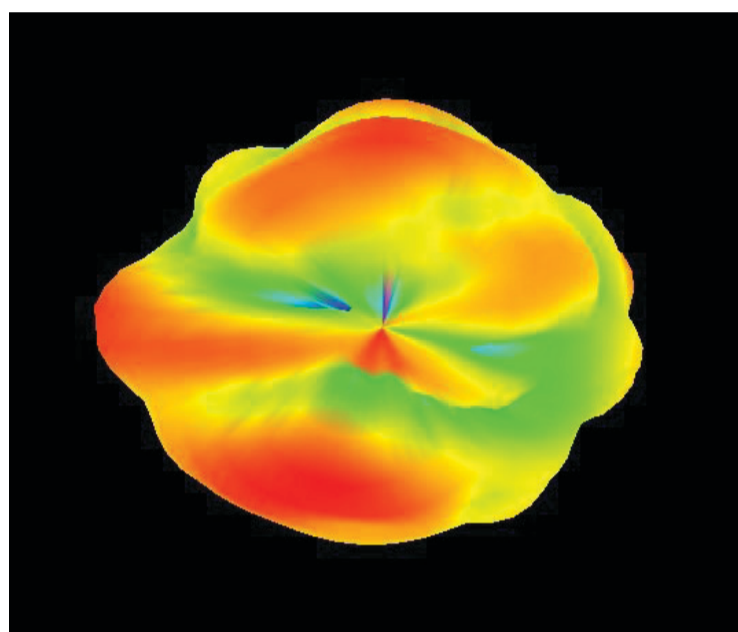

1850 MHz

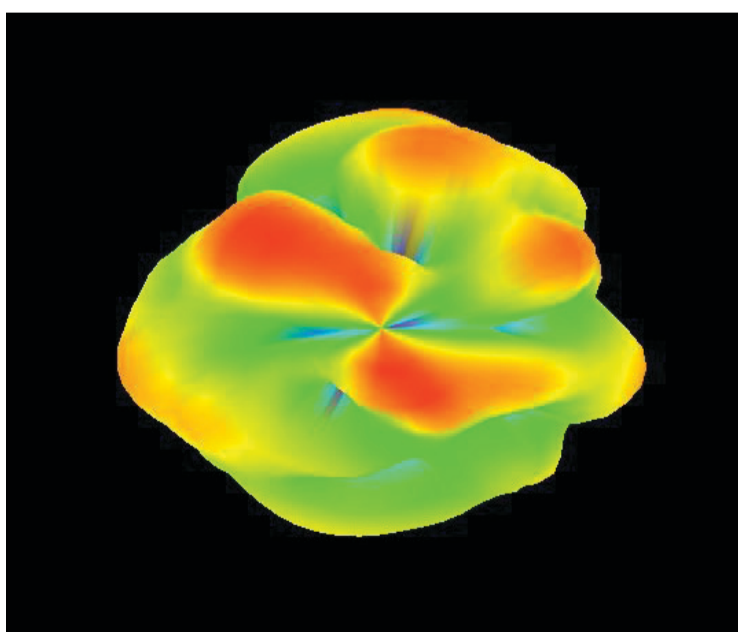

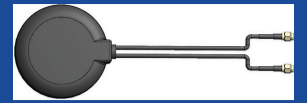

AEACBA081014-M698



Ø81.6 x 14.5 mm
RoHS/RoHS II Compliant

MSL - N/A

3D Radiation Patterns

1990 MHz

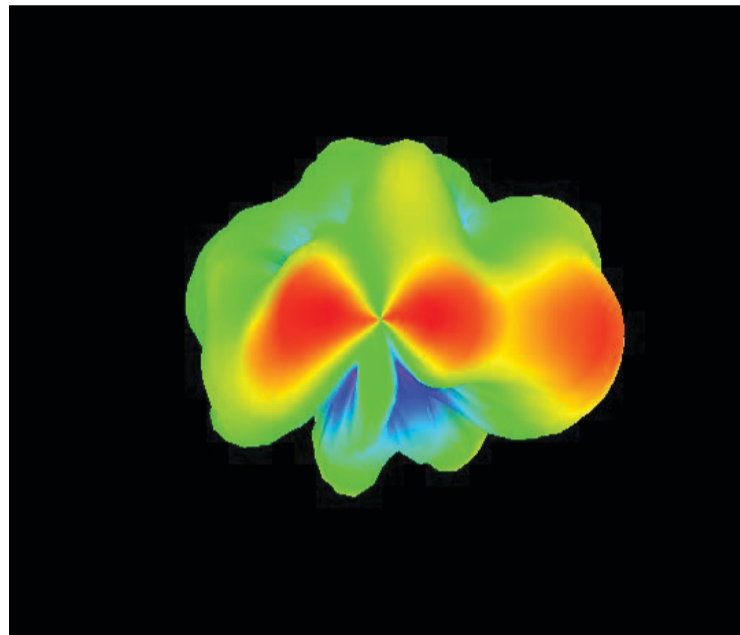

2170 MHz

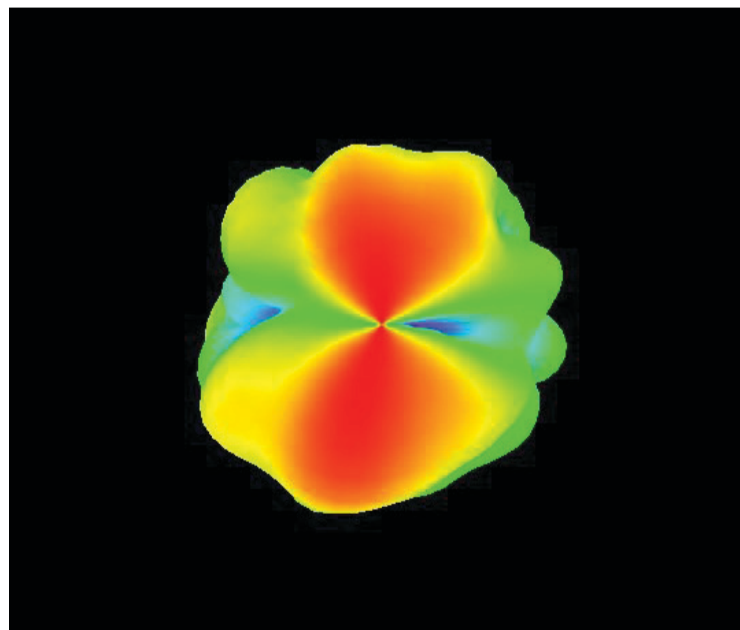

2x2 4G/LTE MIMO Antenna

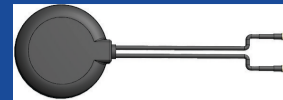

AEACBA081014-M698



Ø81.6 x 14.5 mm
RoHS/RoHS II Compliant

MSL - N/A

3D Radiation Patterns

2690 MHz

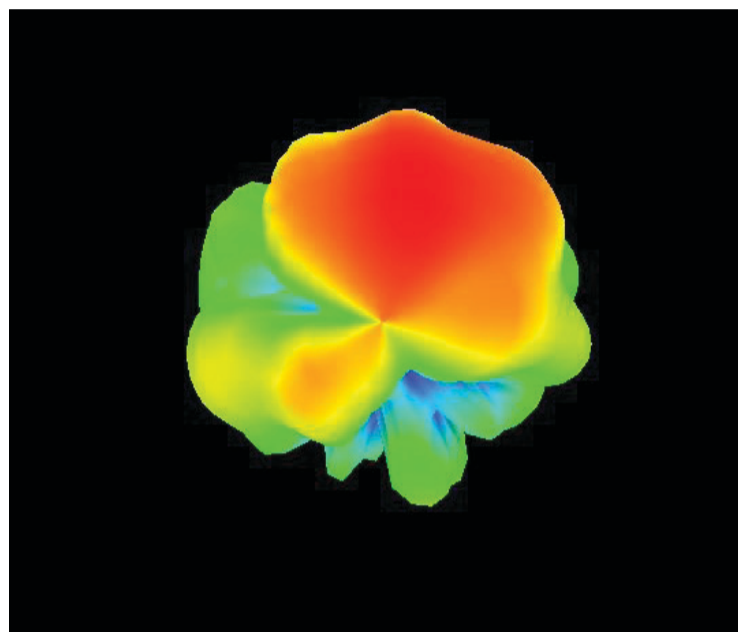

Packaging

Each 70 x 32 x 15.5 mm size carton includes 50 pcs antenna, weighs 7.5 kg.