

2 YEAR
WARRANTY



Ω OMEGA™ **User's Guide**



*Shop online at
omega.com*

*e-mail: info@omega.com
For latest product manuals:
www.omegamanual.info*

DP606A/DP612A
Universal 6/12 Channel 1/4 DIN Panel Meter



omega.com info@omega.com

Servicing North America:

**U.S.A.
Headquarters:**

Omega Engineering, Inc.
800 Connecticut Ave, Suite 5N01
Norwalk, CT 06854 USA
Toll-Free: 1-800-826-6342 (USA & Canada only)
Customer Service: 1-800-622-2378 (USA & Canada only)
Engineering Service: 1-800-872-9436 (USA & Canada only)
Tel: (203) 359-1660 Fax: (203) 359-7700
e-mail: info@omega.com

For Other Locations Visit omega.com/worldwide



Table of Contents

Section Page
Section 1 Introduction 1
Section 2 Installation and Operating Conditions 2
Section 3 Mounting Instructions 3
Section 4 Wiring Instructions 4
4.1 Rear Panel Diagram 4
4.2 Connecting Power 5
4.3 Connecting Alarms 6
4.4 Connecting Communications 7
4.5 Connecting Inputs 7
Section 5 Navigation 8
5.1 RUN Mode 8
5.2 Lock Zones 9
5.3 Clear Alarms 9
5.4 Check Alarm Values 9
5.5 Function Select Mode..... 9
5.6 Reset Defaults 9
5.7 Function Select Mode 10
5.8 Function 1-Enter Password 11
5.9 Function 2-Set Active Zones 11
5.10 Function 3 and 4-Set Low and High Alarms..... 12
5.11 Function 5-Modbus Address 13
5.12 Function 6-Set Scan Time 13
5.13 Function 7-Set Device Configuration 14-15
5.14 Function 8-Password Enable/Disable 16
5.15 Function 9-Calibration 16
5.16 Function A/B-Alarm Relay Function 17
5.17 Function C/D-Scaling 18
5.18 Function F-Serial Configuration 19
Section 6 Serial Interface 20
6.1 Modbus Functions 20
6.2 Data Formats 21
6.3 Multiple Register Reads 21
6.4 Multiple Register Writes 22
6.5 Request Packet Sizes 22

Table of Contents

Section	Page
Section 7 Modbus Register Assignments	23
7.1 System Registers	23
7.2 Temperature Registers	24
7.3 Status Registers	24
7.4 Zone Registers	25
7.5 User Calibration	26
7.6 Enumerated Values	26
7.7 Sensor Type	26
7.8 RTD Type	26
7.9 Thermocouple Type	27
7.10 Sensor Status	27
7.11 System State	27
7.12 Process Unit	28
7.13 Alarm Type	28
7.14 Alarm Status	28
7.15 Setting Toggle	28
Section 8 Specifications	29
8.1 Alarm Relays	29
8.2 Input Accuracy	30
Section 9 Approvals Information	31

Table of Figures and Tables

Figures	Page
Figure 1 Side and Panel Cutout Views	3
Figure 2 DP606A/DP612A: Rear Panel Connections	4
Figure 3 Main Power Connections	5
Figure 4 Relay Connections	6
Figure 5 3 Wire RTD Wiring Diagram	7
Figure 6 Front Panel Diagram	8
Figure 7 Process Input Scaling	18

Table	Page
Table 1 Rear Panel Connections	4
Table 2 9 Pin Input Power/Relay Wiring Summary	5
Table 3 Connecting Communications	7
Table 4 Function Codes	10
Table 5 Device Configuration	14
Table 6 Alarm Relay Configuration	17
Table 7 Serial Port Configuration	19
Table 8 Modbus Functions	20
Table 9 Multiple Register Writes	22
Table 10 Packet Sizes	22
Table 11 System Registers	23
Table 12 Temperature Registers	24
Table 13 Sensor Status Registers	24
Table 14 Zone Registers	25
Table 15 User Calibration	26
Table 16 Input Accuracy	30

Section 1 - Introduction

The DP606A/DP612A Display Meter offers a flexible, easy to use 6 or 12 zone, 4 digit temperature and process measurement solution in a rugged ¼ DIN Aluminum housing. Selectable configuration eliminates the need for jumpers.

The DP606A supports 6 independent zones and the DP612A supports up to 12 zone (3 wire RTD limited to 6 zones on all models). All zones are scanned at a 400ms rate. The display shows the reading of each zone sequentially. High and low Alarms with SPDT relay outputs are available for monitoring and alarm purposes.

The universal input supports 9 thermocouple types (J, K, T, E, R, S, B, C, and N), 2 or 3 wire RTDs (Pt 100, Ni 120, Cu 10), DC voltage (0-1 Vdc), or DC current (0 – 24 mA). Independent alarms are available for each zone. Each alarm can be configured for above (HI), below (LO) or HI/LO triggering. Alarms conditions will be indicated on the display meter and may be used to activate either of the 2 SPDT relay outputs.

A user selectable RS232 or RS485 serial port interface is standard on all models and uses the Modbus RTU protocol for configuration management and data transfer.

The universal AC power supply accepts 90–240 Vac. The isolated DC power option accepts 9–36 Vdc.

A security password can be used to prevent front panel tampering of the configuration.

Section 2 - Installation and Operating Conditions

This Instrument is marked with the international Caution symbol. It is important to read and follow the Setup Guide before installing or commissioning this device. The Guide contains important information relating to safety and EMC.

The instrument is a device protected in accordance with UL 61010:2010 Electrical Safety Requirements for Electrical Equipment for Measurement, Control and Laboratory. The device has no power-on switch. Installations must include a switch or circuit breaker that is compliant to IEC 947-1 and 947-3. It must be suitably located to be easily reached and marked as the disconnecting device for the equipment.

WARNING: Do NOT connect AC power to your device until you have completed all input and output connections. This device is a panel mount device protected in accordance with Class I of EN 61010 (115/230 AC power connections), Class III for the DC power option (9-36Vdc). It must be installed by a trained electrician with corresponding qualifications. Failure to follow all instructions and warnings may result in injury.

Use Copper conductors only, minimum 20 AWG, UL Rated, for power and outputs. Insulation must be rated for at least 85°C and 600V.

This device is not designed for use in, and should not be used for, patient-connected applications.

Safety:

- Do not exceed the voltage rating on the label located on the device housing.
- Always disconnect power before changing signal and power connections.
- Do not operate this instrument in flammable or explosive atmospheres.
- Do not expose this instrument to rain or moisture.

EMC:

- Whenever EMC is an issue use shielded cables.
- Never run signal and power wires in the same conduit.
- Use signal wire connections with twisted-pair cables.
- If EMC problems occur Install Ferrite Bead(s) on signal wires close to the instrument.

 **WARNING:** Failure to follow all instructions and warnings is at your own risk and may result in property damage, bodily injury and/or death. Omega Engineering is not responsible for any damages or loss arising or resulting from any failure to follow any and all instructions or observe any and all warnings.

 **CAUTION:** Risk of electric shock. Disconnect all power sources before servicing.

Section 3 - Mounting Instructions

Select a location for the monitor that is free from excessive shock, vibration, dirt, moisture and oil. Mount the monitor into a 3 5/8" (92mm) square cutout. The monitor as shipped is 1/4 DIN (92mm square), so it does not have to be removed from its housing to be mounted. Remove the two screws that secure the mounting slides. Remove the slides and insert the case into the cutout from the front side of the panel. Reinstall the two slides and two screws. The length of the slides must be reduced if the monitor is to be mounted in an extra thick panel.

Ensure that the unit is properly grounded to the panel which should be earth grounded. Use the supplementary ground point indicated on the rear panel if a good ground connection cannot be maintained from the mounting slides alone.

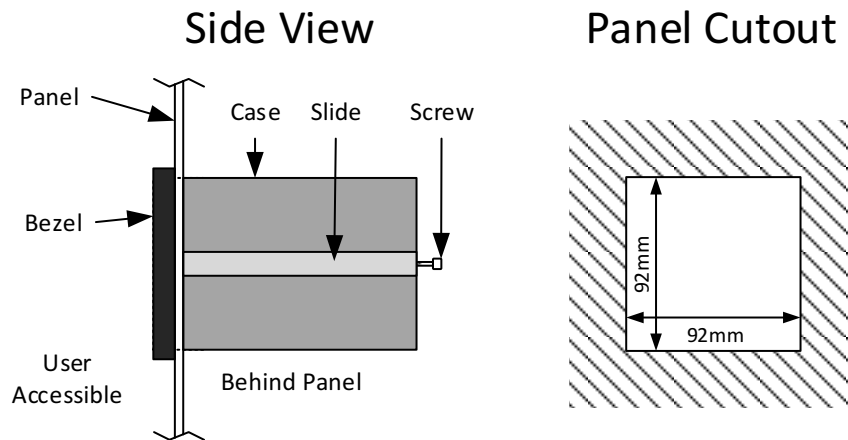

Figure 1 - Side and Panel Cutout Views

Section 4.1 - Rear Panel Diagram

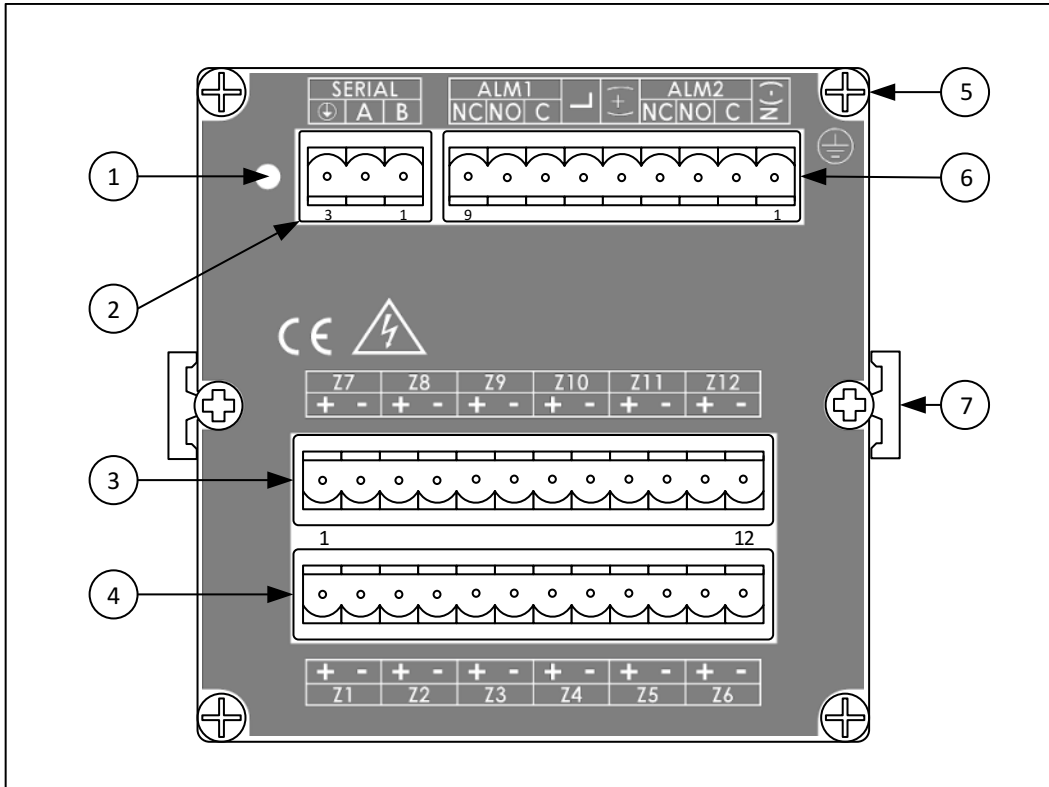

Figure 2 - DP606A/DP612A: Rear Panel Connections

Item	Description
1	Reset Pinhole
2	Serial Connector
3	Input 7 through 12
4	Input 1 through 6
5	Supplementary Ground Point
6	Power and Alarm Connector
7	Mounting Slide

Table 1 - Rear Panel Connections

Caution: Use only provided terminals. Torque all connections to 0.5-0.6Nm.

Section 4.2 - Connecting Power

Pin No.	Code	Description
1	N(-)	Neutral Power / DC-Power supply
2	ALM2 C	Alarm Relay 2 Common
3	ALM2 NO	Alarm Relay 2 Normally Open
4	ALM2 NC	Alarm Relay 2 Normally Closed
5	(+)	DC + Power supply (9-36 VDC)
6	L	Line Power (90-240 VAC)
7	ALM1 C	Alarm Relay 1 Common
8	ALM1 NO	Alarm Relay 1 Normally Open
9	ALM1 NC	Alarm Relay 1 Normally Closed

Table 2 - 9-Pin Input Power/Relay Wiring Summary

Connect the main power connections to pins 4 and 9 (AC Power) or pins 5 (+) and 9 (-) (DC Power) of the 9pin power / output connector as shown in Figure 3.

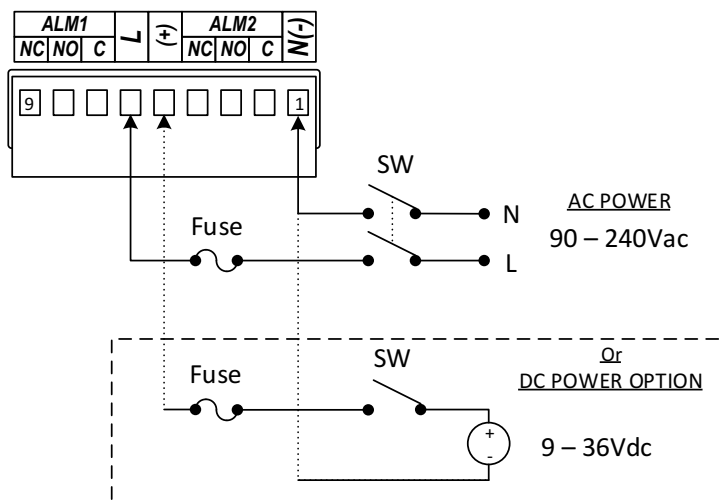

Figure 3 - Main Power Connections



For the low-voltage power option, maintain the same degree of protection as the standard high-voltage input power units (90–240 Vac) by using a Safety Agency Approved DC source with the same Overvoltage Category and pollution degree as the AC model.

The Safety European Standard EN61010-1 for measurement, control, and laboratory equipment requires that fuses must be specified based on IEC127. This standard specifies the letter code “T” for a Time-lag fuse.

Section 4.3 - Connecting Alarms

The DP606A/DP612A Series includes SPDT mechanical relays with internal snubbers on the normally open contact side. When powered and not in an alarm state the relays are Energized and the NO contact is connected to the Relay common contact. If an alarm condition occurs or if the unit loses power the relay is deenergized and the NC contact is connected to the Relay common contact.

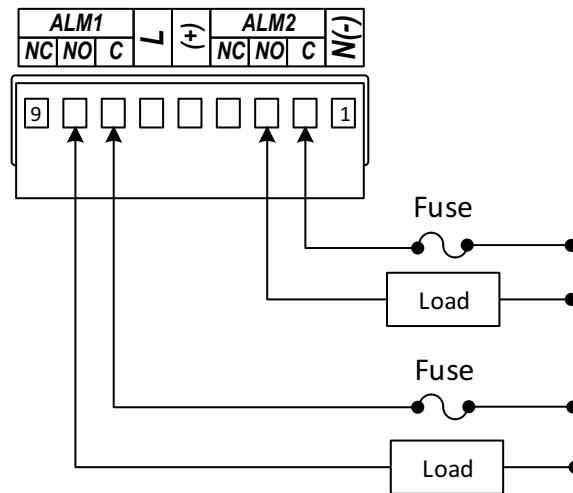

Figure 4 - Relay Connections



WARNING: For the low-voltage power option, maintain the same degree of protection as the standard high-voltage input power units (90–240 Vac) by using a Safety Agency Approved DC or AC source with the same Overvoltage Category and pollution degree as the standard AC unit (90–300 Vac).

The Safety European Standard EN61010-1 for measurement, control, and laboratory equipment requires that fuses must be specified based on IEC127. This standard specifies the letter code "T" for a Time-lag fuse.

Section 4.4 - Connecting Communications

Pin No.	Code	Description
1	B	RS485 B signal, RS232 TX (to remote device)
2	A	RS485 A signal, RS232 RX (from remote device)
3	⊕	RTN signal for serial communications

Table 3 - Connecting Communications

Note: The RTN signal is isolated from the Signal RTN and the Power GND.

Section 4.5 - Connecting Inputs

Connect Input sensors to the terminals Marked Zone 1 through Zone 12 (Z1 – Z12) on the rear panel. For the DP606A only Zones 1 through 6 are active and Terminals Z7 – Z12 are only used for 3 Wire RTDs. When connecting sensors follow the polarity indicated on the rear panel. For Thermocouples the Negative wire is Red (NA) or White (IEC 584-3). For Process Inputs the Negative terminal is ground.

For the RTD 3 wire option the common wires must be connected to the + terminals of both the upper (Z1 – Z6) and lower (Z7 – Z12) input boards. The negative terminal of Z7- Z12 remains unconnected. If a 2 wire RTD needs to be used in 3 Wire mode use a jumper wire to connect the upper and lower terminals together. Refer to the wiring diagram below.

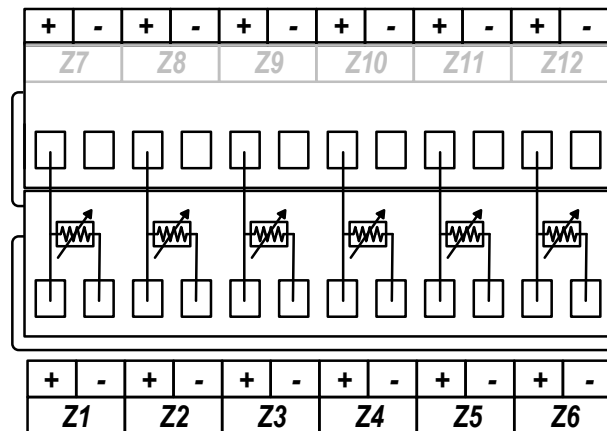

Figure 5 - 3 Wire RTD Wiring Diagram

Note that all negative input terminals share a common internal ground connection. Ensure that all sensors share a common ground or are fully isolated.

Section 5 - Series Navigation

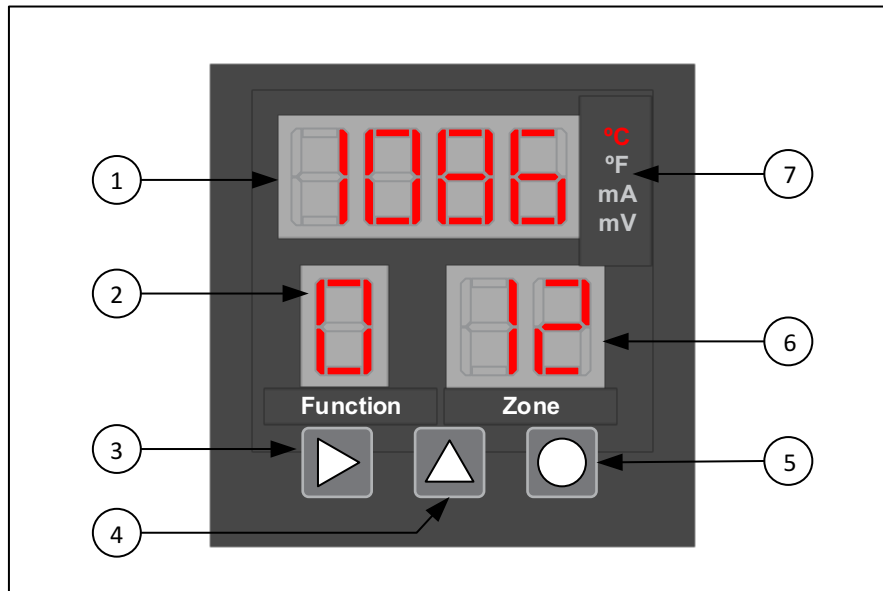

Figure 6 - Front Panel Diagram



Item	Description
1	Main Display
2	Function Display
3	Advance Button
4	Increment Button
5	Select Button
6	Zone Display
7	Unit/Mode Indicator

Section 5.1 - RUN Mode

When power is applied to the unit it will automatically enter the RUN mode, sequentially scanning each active zone and activating alarms if required. The Main display shows the measured value of the indicated zone. The unit will change to each active zone in sequence the user determined rate.

While in the RUN mode the user may lock the display at the current zone, clear any latched alarms, examine the current Alarm values or enter the PROGRAMMING mode.





Section 5.2 - Lock Zones

Symbol	Description
	The display stops cycling thru each display. The currently selected zone information will be continuously updated on the display. Note that all active zones continue to be read and any alarm conditions will activate the enabled alarm relays.
	The Lock option is released and the value display will cycle thru all active zones.

Section 5.3 - Clear Alarms

	Any active, latched alarm is cleared.
---	---------------------------------------

Section 5.4 - Display Alarm Values

	Displays the Alarm Value for the current zone and stops scanning. The Main display shows the Alarm value. The Zone display shows the zone.
	Increments the Zone number and displays the next Alarm Value.
	Switches between HI and LO Alarm Values. The Function display shows 3 when displaying Low values and 4 when displaying High Values.
	Return to Run Mode

Section 5.5 - Function Select Mode

	Enter Function Select Mode from Run Mode
---	--

Section 5.6 - Reset Defaults

	Hold all 3 buttons down for 5 seconds to reset unit to Factory Defaults. The unit will reboot and return to Run Mode.
---	---

Section 5.7 - Function Select Mode



While in function select mode 1 is displayed in the Function Display and the selected function is displayed in the Main display.

The DP606A/DP612A monitor has several different Functions listed in the table below.

Function	Description
0	Return to Run Mode
1	Function Select / Enter Password
2	Set Active Zone
3	Set Low Alarms
4	Set High Alarms
5	Set Modbus Address
6	Set Scan Time
7	Set Model Options
8	Password Enable and Disable
9	Calibration
A	Set Alarm 1 Options
B	Set Alarm 2 Options
C	Set Low Scale
D	Set High Scale
F	Set Serial Options

Table 4 - Function Codes

Navigate Function Select Mode using the button below.



	Increments the Function Code displayed in the Main display.
	Enters the Function displayed in the Function display.

If the Password option is enabled only Functions 0 and 1 will be available. Entering the correct password in Function 1 will unlock the rest of the menu options. If the Password is disabled Function 1 will not be available.

Section 5.8 - Function 1 - Enter Password

A password may be enabled to prevent unintended changes to the unit. The password is a 4 digit code and the default Password is 1011. The password can only be changed using the serial port.

Use the buttons below to enter the password.

	Increment the flashing digit of the Main display
	Selects the next digit of the Main display, causing it to flash
	Enters the Password



After entering the password the unit will return to function select mode. If the password is correct all of the functions will be available. If the password was entered incorrectly it must be re-entered by selecting Function 1 again.

Section 5.9 - Function 2 - Set Active Zones

The main display is blank when selecting active zones. The current zone being edited is shown in the Zone Display. Active zones are displayed solid while disabled zones are displayed flashing. By default all zones are active.

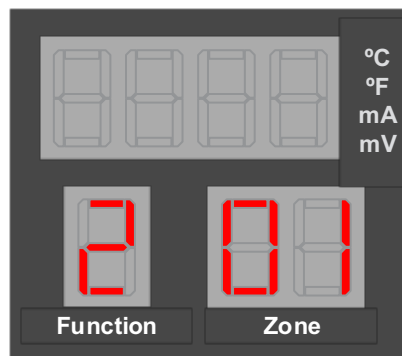
Disabled zones are skipped while scanning and do not generate alarms. Use the buttons below to change the active zone.



	Advance to the next zone.
	Toggles the current zone between enabled (solid) or disabled (flashing).
	Stores the enabled / disabled state for all zones and returns to Function Select mode





Section 5.10 - Function 3 and 4 - Set Low and High Alarms

The High and Low alarm values determine the readings that the Alarms will activate at for each zone. The function selected is indicated in the function display. Function 3 sets the low alarms and Function 4 sets the high alarms. The default Low alarm is -900 and the default High alarm is 9000 for all zones.

The alarms for each zone are independent. The zone for the current alarm being edited is shown in the zone display.

The current alarm value for the selected zone is shown in the main display. The left most digit blinks indicating it can be edited. Use the buttons indicated below to edit the alarm values.



	Increment the flashing digit of the VALUE display.
	Selects the next digit of the VALUE display, causing it to flash.
	Changes the decimal point.
	Stores the current VALUE display as the alarm value for the current zone and advances to the next zone.
	Stores all values and returns to Function Select mode.

Section 5.11 - Function 5 - Set Modbus Address

The Modbus address is used for serial communications to determine which device on a bus is being accessed. The current Modbus Address is shown in the Main Display. The first digit flashes to indicate it can be edited. Use the buttons below to edit the address.

By Default the Modbus address is 1 and any address from 1 to 247 can be used. The unit will not allow an invalid address to be displayed. Trying to enter a number greater than 247 will cause the display to roll back to a valid number.

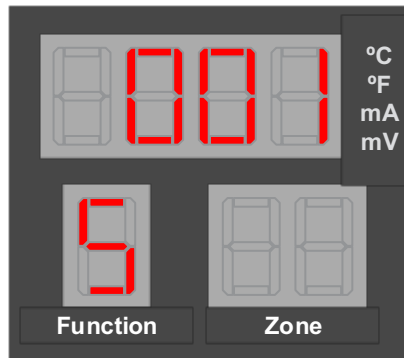

	Increment the flashing digit of the Main display.
	Selects the next digit of the Main display, causing it to flash.
	Stores the Device address and returns to the Function Select mode.

Section 5.12 - Function 6 - Set Scan Time

The scan time is the time each zone is displayed on the front panel before advancing to the next zone. By Default, the scan time is 3 seconds. The current scan time is displayed in the Main Display and the zone display is blank. The left most digit blinks indicating it can be edited. Use the buttons below to edit the scan time.

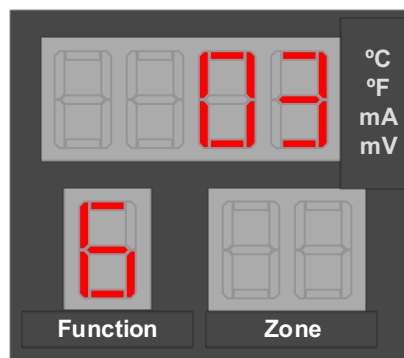

	Increment the flashing digit of the VALUE display.
	Selects the next digit of the VALUE display, causing it to flash.
	Stores the current VALUE display as the SCAN time and returns to the Function Select mode.

Section 5.13 - Function 7 - Set Device Configuration

Function 7 sets the device configuration including the Alarm Type, Units and input type. The default setting for Function 7 is 2204 which represents Thermocouple Type K inputs with High/Low Latching alarms in Degrees Celsius.

Each digit in the Main Display represents a different function. Refer to the table below for the specific functions.

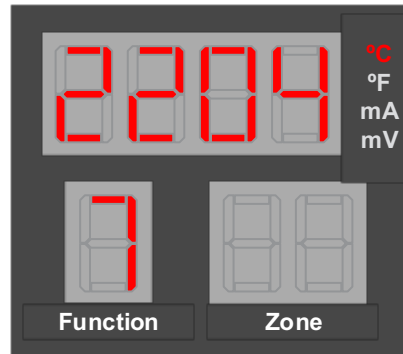

Digit 1		Digit 2			Digit 3		Digit 4			
	Alarm Type		Unit	Alarm Latch		Input Type		TC Type	RTD Type	Decimal Points
0	High	0	C	Latching	0	TC	0	B	Pt100	0
1	Low	1	F	Latching	1	RTD2	1	C	Ni120	1
2	High/Low	2	C	Non-Latching	2	RTD3	2	E	Cu10	2
3	Off	3	F	Non-Latching	3	mA	3	J		3
4	User				4	mV	4	K		
							5	R		
							6	S		
							7	T		
							8	N		

Please note: Digit 4 is dependent upon the "Input Type" selected under Digit 3. Ex: If "TC" is selected under "Input Type" under Digit 3, Digit 4 becomes one of the following "B, C, E, J, etc." under "TC Type." Table 5 - Device Configuration



Section 5.13 - Function 7 - Set Device Configuration cont.

Digit 1 is the Alarm type. High alarms will deactivate the relay when the Zone process value is Above the High Alarm Value defined in Function 4. Low alarms will deactivate the relay when the Zone process value is below the Low alarm defined in Function 3. High/Low will trigger on both alarms and Off will not trigger alarms at all. If different operation is desired for Relay 1 and Relay 2 or if different alarm types need to be used per zone these can be setup in Functions A and B by selecting User controlled.

Digit 2 defines the Units displayed for TC and RTD inputs. It also selects between Latching and Non-Latching alarms. Latching alarms will remain active until the latch is cleared by the user regardless of the current input value. Non-latching alarms will deactivate as soon as the input no longer meets the alarm conditions. The Alarm Latch Type is overwritten by the User settings if user is selected for the Alarm Type.

Digit 3 selects between the available input types. The input type cannot be changed individually per zone. When selecting RTD 3 wire input only 6 zones will be active on a 12 Zone unit.

Digit 4 is context sensitive and depends on Digit 3. If TC or RTD type input are selected Digit 4 selects the type of sensor. If mV or mA type input are selected Digit 4 represents the maximum number of decimal points that will be displayed. If all decimal points cannot be displayed the display will be rounded to the nearest displayable number. Temperature readings can only be displayed to the nearest whole number.

	Increment the flashing digit of the VALUE display.
	Selects the next digit of the VALUE display, causing it to flash.
	Stores the current VALUE display as the Input Type advances to the next zone. Note that this button will have no effect if the VALUE display is selecting an invalid input type.

Section 5.14 - Function 8 - Password Enable/Disable

Using Function 8, a user password may be enabled to protect the unit from inadvertent changes. By Default the Password is disabled.

The default password is 1011. This can only be changed using the serial port.

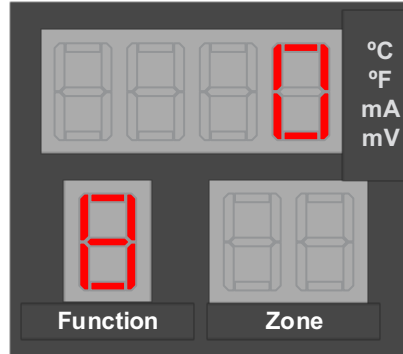

	Toggle the password from enabled (1) and disabled (0)
	Stores the current VALUE display as the password enabled state and returns to the Function Select mode.

Section 5.15 - Function 9 - Calibration

The DP600A and DP612A are factory calibrated and do not require additional user calibration under most circumstances. For 2 wire RTDs Function 9 may be used to calibrate out lead wire resistance. This calibration is done independently for each channel.

To perform lead wire calibration short the RTD that needs to be calibrated at the end of the lead wire. Next select the Zone to be calibrated in the primary Display using the increment button. Press the select button to perform the calibration. While the unit is calibrating the Zone flashes to indicate it is busy. Once the calibration is complete the Zone will stop flashing. If the lead wire resistance is more than 10 ohms the unit will display "FAIL" and the calibration value will be set to 0.

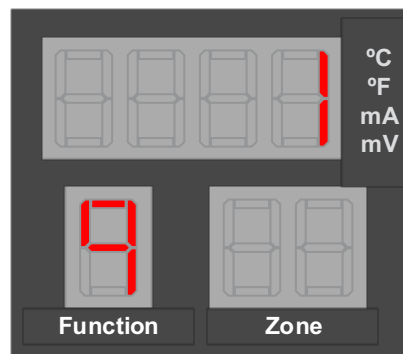

	Scroll to next zone
	Perform Calibration on current zone
	Returns to Function Select mode

Section 5.16 - Function A/B - Alarm Relay Function

When split operation is selected in Function 7, Alarm relay operation is customized using functions A and B.

Function A Controls Alarm 1 and Function B controls Alarm 2. Each zone may be assigned to one or more relays. By Default, Alarm 1 is assigned high / low alarms for all zones and Alarm 2 is Disabled for all zones. The Current Zone being edited is shown in the Zone Display. The current mode for that zone is displayed in the Main Display.

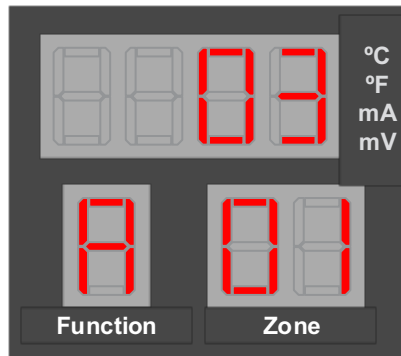

	Increment the flashing digit of the VALUE display
	Selects the next digit of the VALUE display, causing it to flash
	Moves to the next zone
	Stores all values and returns to Function Select mode

Digit 1		Digit 2	
	Alarm Latching		Alarm Type
0	Not Latched	0	High Alarm
1	Latching relay	1	Low Alarm
		2	High and Low Alarm
		3	Alarm Disabled

Table 6 - Alarm Relay Configuration

Section 5.17 - Function C/D - Scaling

Functions C and D set the scaling for the mA and mV input. Function C sets the Low Scale and Function D sets the High Scale. The scaling factors for mA and mV are separate so the values corresponding to the input type selected in Function 7 are shown.

By default the scaling is set to display the measurement in mA/mV.

Scaling factors are applied independently for each zone. The current zone being modified is displayed in the Zone Display. Enter the value to be displayed at 4mA or 0V in Function C and the value to be displayed at 20mA or 1V in function D. Values between the two points are linearly interpolated.

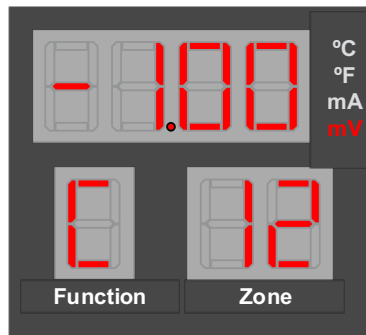

	Increment the flashing digit
	Selects the next digit, causing it to flash
	Changes the decimal point
	Stores the current scaling factor for the indicated zone advances to the next zone.
	Stores all values and returns to Function Select mode

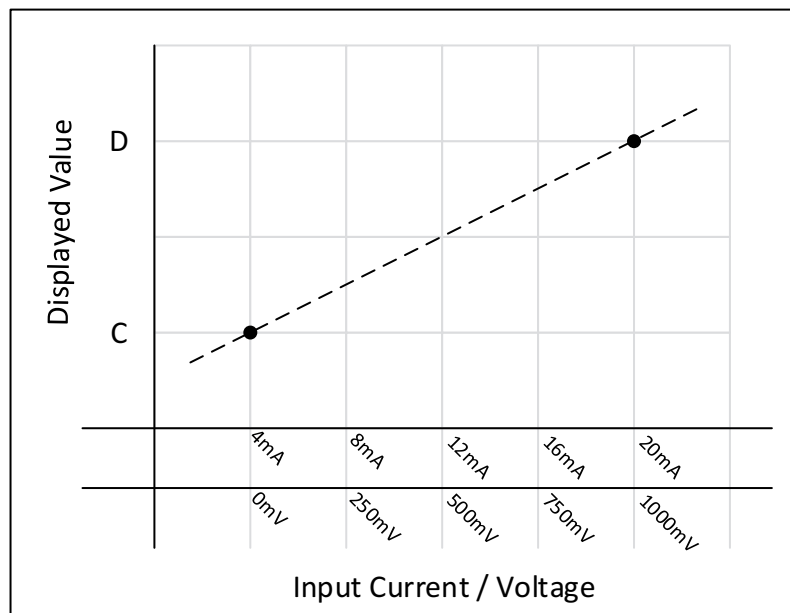





Figure 7 - Process Input Scaling

Section 5.18 - Function F - Serial Configuration

Function F sets up the serial port of the device. The default serial settings are RS485, 115.2k baud no Parity.

	Increment the flashing digit on the display
	Selects the next digit of the VALUE display, causing it to flash.
	Stores the current VALUE display as the Serial configuration and returns to the Function Select mode. This button will have no effect if the current VALUE is does not match a valid configuration.

Digit 1		Digit 2		Digit 3		Digit 4 (LSD)	
	Signaling Type		Baud Rate		Parity		
0	RS485	0	4800	0	None	0	Reserved
1	RS232	1	9600	1	Odd		
		2	19200	2	Even		
		3	38400				
		4	57600				
		5	115200				

Table 7 - Serial Port Configuration

Section 6 - Serial Interface

The DP606A and DP612A uses the Modbus/RTU interface as described in MODBUS APPLICATION PROTOCOL SPECIFICATION (V1.1b3).

The Modbus specification allows accessing to up 65535 internal 'holding' registers using register READ, register WRITE and WRITE MULTIPLE commands. Each Modbus holding register is defined as a 16 bit entity structured as BIG ENDIAN values (most significant byte always presented first).

Modbus is structured using a MASTER-SLAVE topology, in which there is one MASTER device and up to 247 slave devices. All transactions are initiated by the MASTER device. The DP606A and DP612A acts as a slave device, with a device address in the range 1 to 247.

Modbus slave devices are individually accessed using a one byte SLAVE address. The MASTER device initiates a transaction by sending a request packet to a specific slave. The SLAVE device processes the transaction and returns either response packet indicating success or failure.

Address 0 is reserved as a 'broadcast' address, in which all slave devices will accept and process the transaction but will not send a response.

Section 6.1 - Modbus Functions

The DP606A and DP612A Modbus interface supports the following Modbus FUNCTION requests.

Function Code	Mnemonic	Description
0x03	Read Holding Register	Reads one or more consecutive 16 bit holding registers
0x06	Write Single Register	Writes a specific 16 bit holding register
0x07	Read Exception status	Reads structured status information
0x08	Reserved	
0x10	Write Multiple Registers	Write one or more consecutive 16 bit holding registers
0x0b	Get Comm events	Read communication event counters

Table 8 - Modbus Functions

Section 6.2 - Data Formats

Modbus holding registers are represented as 16 bit entities. The following encoding is used for extended data items. Note that 'byte 0' will be the first byte received/transmitted.

For data types that can be represented in 16 bits (Boolean, byte, char, int16 and uint16) a single register is used.

For data types that require 32 bits two consecutive registers are used. The lower number register will represent the most significant data. The 2nd register represents the least significant data.

Section 6.3 - Multiple Register Reads

When reading a dual register entity the lower order register should be used as the requested 'holding register', with a request for a minimum of 2 registers. Internally the entire entity is read and data is then built into a response packet.

The access can be split into 2 consecutive single register reads. When the lower (base) register is accessed the entire 32 bit entity is read and the two most significant bytes are returned. The following single register read must specify the next consecutive register address. The two least significant bytes of the internally buffered data used in the response.

Attempts to access the two least significant bytes without first reading the two most significant bytes will result in an error response.

Section 6.4 - Multiple Register Writes

When writing a dual register entity the lower order register should be used as the requested 'holding register', with a request for minimum of 2 registers. The write data is internally buffered and transferred to the database entry as a 32-bit value.

The access can be split into 2 consecutive single register writes. When the lower (base) register is written the 16-bit entity is internally buffered BUT NO DATA TRANSFER IS MADE TO THE DATABASE. The following single register write must specify the next consecutive register address. The two least significant bytes of the write request are combined with the previous write data and the entire 32-bit entity is written to the database.

Attempts to write the two least significant bytes without first writing the two most significant bytes will result in an error response.

Data Types	Number of Registers	Byte				Description
		0	1	2	3	
Boolean	1		LSB	N/A		Zero= OFF, non-zero = ON
Byte, Char	1		LSB	N/A		Entity contained in LSB of register, Byte 0 ignored.
Int16, uint16	1	MSB 0	LSB 1	2	3	Entity contained in MSB/LSB of register. (dual register data)
Int32, uint32	2	MSB	B-1	B-2	LSB	Requires 2 consecutive registers, MSB transferred first
float	2	Sign+E xp	Mantisa MSB	B-1	Mantisa LSB	IEEE formatted value contained in 2 consecutive registers

Table 9 - Multiple Register Writes

Section 6.5 - Request Packet Sizes

Multiple consecutive registers may be accessed in a single transaction.

The DP606A and DP612A Modbus interface imposes a maximum of 72 bytes for the total transaction. Allowing for the required framing, addressing and CRC results in the following data size restrictions using the READ and WRITE MULTIPLE functions.

Format	Protocol Overhead	Maximum Read data	Maximum Write data
RTU	8	24 Registers	24 Registers

Table 10 - Packet Sizes

Section 7 - DP606A and DP612A Modbus Register Assignments

All accesses to the DP606A and DP612A database information is made thru the following Modbus registers.

Data types:

R – single 16 bit register (may be Boolean, byte, char, int16 or uint16 data)

L – dual (32 bit) register (may be int32 or uint32 data)

F – IEEE Floating point value

B – Byte Array

All data is transferred using Big Endian formatting, where the most significant byte is transmitted first.

Section 7.1 - System Registers

Index		Mnemonic	Type	Access	Description
0x0000	40000	Layout Version	R	R	Hardware layout version
0x0001	40001	Device Description	R	R	Device description
0x0002	40002	FW Version Major Minor	R	R	First two octets of Firmware Version
0x0003	40003	FW Version Minor Fix	R	R	Last two octets of Firmware Version
0x0004	40004	HW Version	R	R	Hardware version
0x0005	40005	Max Zones	R	R	Max zones supported by device
0x0006	40006	Temperature Scale	R	RW	Select Fahrenheit or Celsius degree
0x0007	40007	Sensor Type	R	RW	Enumerated sensor type
0x0008	40008	Sensor Subtype	R	RW	Enumerated sensor sub-type
0x0009	40009	Password	R	RW	4 digit password
0x000a	40010	Modbus Address	R	RW	Device address on the bus.
0x000b	40011	Scan Time Second	R	RW	Display time per zone in seconds
0x000c	40012	Active Zone	R	RW	Bitmap of currently active zone
0x000d	40013	Hours Operation	R	RW	Accumulated hours of operation
0x0013	40019	Factory Default	R	RW	Reset device to factory default
0x0015	40021	System State	R	RW	Enumerated system state
0x0018	40024	System Alarm Type	R	RW	Enumerated alarm type
0x0019	40025	System Alarm Latch	R	RW	Enumerated setting toggle
0x001A	40026	Password Enable	R	RW	Enumerated toggle setting
0x001b	40027	Decimal Point	R	RW	Enumerated decimal point setting

Table 11 - System Registers

Section 7.2 - Temperature Registers

Index		Mnemonic	Type	Access	Description
0x0100	40256	Temperature Zone 1	F	R	Zone 1 Process Value
0x0102	40258	Temperature Zone 2	F	R	Zone 2 Process Value
0x0104	40260	Temperature Zone 3	F	R	Zone 3 Process Value
0x0106	40262	Temperature Zone 4	F	R	Zone 4 Process Value
0x0108	40264	Temperature Zone 5	F	R	Zone 5 Process Value
0x010a	40266	Temperature Zone 6	F	R	Zone 6 Process Value
0x010c	40268	Temperature Zone 7	F	R	Zone 7 Process Value
0x010e	40270	Temperature Zone 8	F	R	Zone 8 Process Value
0x0110	40272	Temperature Zone 9	F	R	Zone 9 Process Value
0x0112	40274	Temperature Zone 10	F	R	Zone 10 Process Value
0x0114	40276	Temperature Zone 11	F	R	Zone 11 Process Value
0x0116	40278	Temperature Zone 12	F	R	Zone 12 Process Value

Table 12 - Temperature Registers

Section 7.3 - Status Registers

Index		Mnemonic	Type	Access	Description
0x0180	40384	Sensor Status Zone 1	R	R	Zone 1 Sensor status
0x0181	40385	Sensor Status Zone 2	R	R	Zone 2 Sensor status
0x0182	40386	Sensor Status Zone 3	R	R	Zone 3 Sensor status
0x0183	40387	Sensor Status Zone 4	R	R	Zone 4 Sensor status
0x0184	40388	Sensor Status Zone 5	R	R	Zone 5 Sensor status
0x0185	40389	Sensor Status Zone 6	R	R	Zone 6 Sensor status
0x0186	40390	Sensor Status Zone 7	R	R	Zone 7 Sensor status
0x0187	40391	Sensor Status Zone 8	R	R	Zone 8 Sensor status
0x0188	40392	Sensor Status Zone 9	R	R	Zone 9 Sensor status
0x0189	40393	Sensor Status Zone 10	R	R	Zone 10 Sensor status
0x018a	40394	Sensor Status Zone 11	R	R	Zone 11 Sensor status
0x018b	40395	Sensor Status Zone 12	R	R	Zone 12 Sensor status
0x018c	40396	Sensor Status Bitmap	R	R	Sensor status bitmap for all zones
0x018d	40397	Alarm Status Bitmap	R	R	Alarm status bitmap for all zones

Table 13 - Sensor Status Registers

Section 7.4 - Zone Registers

The zone specific registers are repeated

Zone 1 Register Base = 0x200

Zone 2 Register Base = 0x280

Zone 3 Register Base = 0x300

Zone 4 Register Base = 0x380

Zone 5 Register Base = 0x400

Zone 6 Register Base = 0x480

Zone 7 Register Base = 0x500

Zone 8 Register Base = 0x580

Zone 9 Register Base = 0x600

Zone 10 Register Base = 0x680

Zone 11 Register Base = 0x700

Zone 12 Register Base = 0x780

Index	Mnemonic	Type	Access	Description
Base + 0x00	Setpoint High	F	RW	Setpoint High for alarm
Base + 0x02	Setpoint Low	F	RW	Setpoint Low for alarm
Base + 0x04	Alarm 1 Mode	R	RW	Enumerated alarm mode
Base + 0x05	Alarm 1 Latch	R	RW	Enumerated setting toggle
Base + 0x06	Alarm 1 Status	R	RW	Enumerated alarm status
Base + 0x07	Alarm 2 Mode	R	RW	Enumerated alarm mode
Base + 0x08	Alarm 2 Latch	R	RW	Enumerated setting toggle
Base + 0x09	Alarm 2 Status	R	RW	Enumerated alarm status
Base + 0x0a	Current Scale High	F	RW	High scale reading for current input
Base + 0x0c	Current Scale Low	F	RW	Low scale reading for current input
Base + 0x0e	Voltage Scale High	F	RW	High scale reading for voltage input
Base + 0x10	Voltage Scale Low	F	RW	Low scale reading for voltage input

Table 14 - Zone Registers

Example:

Current Scale High register for Zone 7

Index = 40,000 + Base + Index = 40,000 + 0x500 + 0x0a = 41290

Section 7.5 - User Calibration

Index		Mnemonic	Type	Access	Description
0x1d7c	47548	Zone 1 RTD offset	F	RW	Offset Ohm for Zone 1
0x1d7e	47550	Zone 2 RTD offset	F	RW	Offset Ohm for Zone 2
0x1d80	47552	Zone 3 RTD offset	F	RW	Offset Ohm for Zone 3
0x1d82	47554	Zone 4 RTD offset	F	RW	Offset Ohm for Zone 4
0x1d84	47556	Zone 5 RTD offset	F	RW	Offset Ohm for Zone 5
0x1d86	47558	Zone 6 RTD offset	F	RW	Offset Ohm for Zone 6
0x1d88	47560	Zone 7 RTD offset	F	RW	Offset Ohm for Zone 7
0x1d8a	47562	Zone 8 RTD offset	F	RW	Offset Ohm for Zone 8
0x1d8c	47564	Zone 9 RTD offset	F	RW	Offset Ohm for Zone 9
0x1d8e	47566	Zone 10 RTD offset	F	RW	Offset Ohm for Zone 10
0x1d90	47568	Zone 11 RTD offset	F	RW	Offset Ohm for Zone 11
0x1d92	47570	Zone 12 RTD offset	F	RW	Offset Ohm for Zone 12

Table 15 - User Calibration

Section 7.6 - Enumerated Values

The following define the Enumerated values.

Section 7.7 - Sensor Type

Sensor Type		
0	THERMOCOUPLE	Thermocouple input
1	RTD 2 WIRE	Two wire RTD input
2	RTD 3 WIRE	Three wire RTD input
3	CURRENT	Process Current input
4	VOLTAGE	Process Voltage input

Section 7.8 - RTD Type

RTD Type		
0	PT_100	Platinum Pt100 RTD
1	NI_90	Nickel Ni90 RTD
2	CU_10	Copper Cu10 RTD
3	NI_120	Nickel Ni120 RTD

Section 7.9 - Thermocouple Type

Thermocouple Type		
0	TYPE_B	Thermocouple B type
1	TYPE_C	Thermocouple C type
2	TYPE_E	Thermocouple E type
3	TYPE_J	Thermocouple J type
4	TYPE_K	Thermocouple K type
5	TYPE_R	Thermocouple R type
6	TYPE_S	Thermocouple S type
7	TYPE_T	Thermocouple T type
8	TYPE_N	Thermocouple N type

Section 7.10 - Sensor Status

Sensor Status		
0	VALID	Sensor is normal
1	OUT_OF_RANGE_LOW	Sensor Reading is below valid range
2	OUT_OF_RANGE_HIGH	Sensor Reading is above valid range
3	SHORT_CIRCUIT	Sensor is short circuit
4	OPEN_CIRCUIT	Sensor is open circuit

Section 7.11 - System State

System State		
0	PROGRAM_MODE	Alarms are disabled
1	RUN_MODE	Alarms are enabled.

Section 7.12 - Process Unit

Process Unit		
0	DEGREE_C	Process unit is Celsius
1	DEGREE_F	Process unit is Fahrenheit

Section 7.13 - Alarm Type

Alarm Type		
0	ALARM_HIGH	Alarm activated when PV > Alarm High SP
1	ALARM_LOW	Alarm activated when PV < Alarm Low SP
2	HI_LOW_ALARM	Alarm activated when Alarm Low SP < PV < Alarm High SP
3	ALARM_OFF	Alarm is disabled.
4	ALARM_SPLIT_A_B	Alarm 1 activates Alarm relay A, alarm 2 activates Alarm relay B

Section 7.14 - Alarm Status

Alarm Status		
0	ALARM_NONE	No alarm condition is triggered
1	ALARM_HIGH	Alarm high condition is triggered
2	ALARM_LOW	Alarm low condition is triggered
3	ALARM_HIGH_LOW	Alarm high low condition is triggered

Section 7.15 - Setting Toggle

Toggle		
0	DISABLE	Setting is disabled.
1	ENABLE	Setting is enabled.

Section 8 - Specifications

Display	4-digit, 7-segment LED; red, 21 mm (0.83)
Dimensions	95 x 95 x 135mm
Panel Cutout	¼ DIN 92 x 92mm
Environmental Conditions	-20 to +70°C (-4 to +158°F), 90% RH non-condensing (Operating) -40 to +85°C (-40 to +185°F), 90% RH non-condensing (Storage) Pollution Degree 2 Altitude of up to 2000 meters Indoor use
External Fuse Required	Time-Delay, UL 248-14* listed: • 25 mA/250 V • 300 mA/250 V (Low-Voltage Option) Time-Lag, IEC 127-3 recognized: • 25 mA/250 V • 300 mA/250 V (Low-Voltage Option)
Line Voltage/Power	120/240 Vac, 50/60Hz, 3W Max
Low-Voltage/Power Option	External power source must meet Safety Agency Approvals. 9–36 Vdc, 3W Max
Protection	NEMA-1/Type 1 front bezel
Weight	725 g
Communications	Selectable RS232 / RS485 Modbus RTU

* For UL installations

Section 8.1 - Alarm Relays

AC Power Option	2x SPDT, 240Vac, 5A Load 5A External Fuse Required
DC Power Option	2x SPDT, 36Vdc, 3A Load 3A External Fuse Required

Section 8 - Input Accuracy

Measurement Ranges and Accuracies based on Operating Temperature			Operating Temperature		
Input Type	Description	Range	Accuracy (25°C)	Accuracy (0 to 50°C)	Accuracy (-20 to 70°C)
Process	Process Voltage	0 to 1000 mV	± 1 mV	± 1 mV	± 1 mV
	Process Current	0 to 24.00 mA	± 10 µA	± 10 µA	± 10 µA
J Type T/C	J Iron-Constantan	-150 to 0°C	± 1.0°C	± 2.0°C	± 6.0°C
		0 to 1200°C	± 1.0°C	± 1.0°C	± 2.0°C
K Type T/C	CHROMEGA™ - ALOMEGA™	-150 to 0°C	± 1.0°C	± 2.0°C	± 5.0°C
		0 to -1372°C	± 1.0°C	± 1.0°C	± 2.0°C
T Type T/C	Copper-Constantan	-150 to 0°C	± 1.0°C	± 2.0°C	± 7.0°C
		0 to 400°C	± 1.0°C	± 1.0°C	± 2.0°C
E Type T/C	CHROMEGA™ -Constantan	-150 to 0°C	± 1.0°C	± 2.0°C	± 5.0°C
		0 to 1000°C	± 1.0°C	± 1.0°C	± 2.0°C
R Type T/C	Pt/13%Rh-Pt	-50 to 0°C	± 1.0°C	± 2.0°C	± 6.0°C
		0 to 1788°C	± 1.0°C	± 1.0°C	± 2.0°C
S Type T/C	Pt/10%Rh-Pt	-50 to 0°C	± 1.0°C	± 2.0°C	± 5.0°C
		0 to 1768°C	± 1.0°C	± 1.0°C	± 2.0°C
B Type T/C	30%Rh-Pt/6%Rh-Pt	150 to 700°C	± 1.0°C	± 2.0°C	± 3.0°C
		700 to 1820°C	± 1.0°C	± 1.0°C	± 1.0°C
C Type T/C	5%Re-W/26%Re-W	0 to 2320°C	± 1.0°C	± 1.0°C	± 3.0°C
N Type T/C	Nicrosil-Nisil	-150 to 0°C	± 1.0°C	± 2.0°C	± 5.0°C
		0 to 1300°C	± 1.0°C	± 1.0°C	± 2.0°C
RTD 2/3 Wire	Pt, 0.00385, 100 Ω	-200 to 850°C	± 1.0°C	± 1.0°C	± 1.0°C
RTD ½ Wire	Cu, 0.00427, 10 Ω	-200 to 260°C	± 1.0°C	± 1.0°C	± 1.0°C
RTD ¾ Wire	Ni, 0.00672, 120 Ω	-80 to 260°C	± 1.0°C	± 1.0°C	± 1.0°C

Table 16 - Input Accuracy

* Absolute Maximum 3.3V (Process Voltage) or 30mA (Process Current).



This product conforms to the EMC: 2014/30/EU (EMC Directive).

Electrical Safety:

This product conforms to the LVD: 2014/35/EU (Low Voltage Directive)

UL / CSA

UL 61010-1 / CSA C22.2 NO. 61010-1-12

Safety Requirements for Electrical Equipment for Measurement, Control, and Laboratory Use

UL 61010-2-201 / CSA C22.2 NO. 61010-2-201:14

Standard for Safety Requirements for Electrical Equipment for Measurement, Control, and Laboratory Use. Part 2-201: Particular requirements for control equipment

UL File Number: E209855



***Correct Disposal of This Product
(Waste Electrical & Electronic Equipment)***

In conformity with Directive 2012/19/EU-WEEE, this marking shown on the product or its literature, indicates that it should not be disposed of, with other household wastes at the end of its working life. To prevent possible harm to the environment or human health from uncontrolled waste disposal, please separate this product from other types of wastes and recycle it responsibly to promote the sustainable reuse of material resources. Household users should contact either the retailer where they purchased this product, or their local government office, for details of where and how they can return this item for environmentally safe recycling. Business users should contact their supplier and check the terms and conditions of the purchase contract. This product should not be mixed with other commercial wastes for disposal

WARRANTY/DISCLAIMER

OMEGA ENGINEERING, INC. warrants this unit to be free of defects in materials and workmanship for a period of **25 months** from date of purchase. OMEGA's WARRANTY adds an additional one (1) month grace period to the normal **two (2) year product warranty** to cover handling and shipping time. This ensures that OMEGA's customers receive maximum coverage on each product.

If the unit malfunctions, it must be returned to the factory for evaluation. OMEGA's Customer Service Department will issue an Authorized Return (AR) number immediately upon phone or written request. Upon examination by OMEGA, if the unit is found to be defective, it will be repaired or replaced at no charge. OMEGA's WARRANTY does not apply to defects resulting from any action of the purchaser, including but not limited to mishandling, improper interfacing, operation outside of design limits, improper repair, or unauthorized modification. This WARRANTY is VOID if the unit shows evidence of having been tampered with or shows evidence of having been damaged as a result of excessive corrosion; or current, heat, moisture or vibration; improper specification; misapplication; misuse or other operating conditions outside of OMEGA's control. Components in which wear is not warranted, include but are not limited to contact points, fuses, and triacs.

OMEGA is pleased to offer suggestions on the use of its various products. However, OMEGA neither assumes responsibility for any omissions or errors nor assumes liability for any damages that result from the use of its products in accordance with information provided by OMEGA, either verbal or written. OMEGA warrants only that the parts manufactured by the company will be as specified and free of defects. OMEGA MAKES NO OTHER WARRANTIES OR REPRESENTATIONS OF ANY KIND WHATSOEVER, EXPRESSED OR IMPLIED, EXCEPT THAT OF TITLE, AND ALL IMPLIED WARRANTIES INCLUDING ANY WARRANTY OF MERCHANTABILITY AND FITNESS FOR A PARTICULAR PURPOSE ARE HEREBY DISCLAIMED. LIMITATION OF LIABILITY: The remedies of purchaser set forth herein are exclusive, and the total liability of OMEGA with respect to this order, whether based on contract, warranty, negligence, indemnification, strict liability or otherwise, shall not exceed the purchase price of the component upon which liability is based. In no event shall OMEGA be liable for consequential, incidental or special damages.

CONDITIONS: Equipment sold by OMEGA is not intended to be used, nor shall it be used: (1) as a "Basic Component" under 10 CFR 21 (NRC), used in or with any nuclear installation or activity; or (2) in medical applications or used on humans. Should any Product(s) be used in or with any nuclear installation or activity, medical application, used on humans, or misused in any way, OMEGA assumes no responsibility as set forth in our basic WARRANTY/DISCLAIMER language, and, additionally, purchaser will indemnify OMEGA and hold OMEGA harmless from any liability or damage whatsoever arising out of the use of the Product(s) in such a manner.

RETURN REQUESTS/INQUIRIES

Direct all warranty and repair requests/inquiries to the OMEGA Customer Service Department. BEFORE RETURNING ANY PRODUCT(S) TO OMEGA, PURCHASER MUST OBTAIN AN AUTHORIZED RETURN (AR) NUMBER FROM OMEGA'S CUSTOMER SERVICE DEPARTMENT (IN ORDER TO AVOID PROCESSING DELAYS). The assigned AR number should then be marked on the outside of the return package and on any correspondence.

The purchaser is responsible for shipping charges, freight, insurance and proper packaging to prevent breakage in transit.

FOR **WARRANTY** RETURNS, please have the following information available BEFORE contacting OMEGA:

1. Purchase Order number under which the product was PURCHASED,
2. Model and serial number of the product under warranty, and
3. Repair instructions and/or specific problems relative to the product.

FOR **NON-WARRANTY** REPAIRS, consult OMEGA for current repair charges. Have the following information available BEFORE contacting OMEGA:

1. Purchase Order number to cover the COST of the repair,
2. Model and serial number of the product, and
3. Repair instructions and/or specific problems relative to the product.

OMEGA's policy is to make running changes, not model changes, whenever an improvement is possible. This affords our customers the latest in technology and engineering.

OMEGA is a trademark of OMEGA ENGINEERING, INC.

© Copyright 2018 OMEGA ENGINEERING, INC. All rights reserved. This document may not be copied, photocopied, reproduced, translated, or reduced to any electronic medium or machine-readable form, in whole or in part, without the prior written consent of OMEGA ENGINEERING, INC.

Where Do I Find Everything I Need for Process Measurement and Control? **OMEGA...Of Course!** *Shop online at omega.com*

TEMPERATURE

- ☑ Thermocouple, RTD & Thermistor Probes, Connectors, Panels & Assemblies
- ☑ Wire: Thermocouple, RTD & Thermistor
- ☑ Calibrators & Ice Point References
- ☑ Recorders, Controllers & Process Monitors
- ☑ Infrared Pyrometers

PRESSURE, STRAIN AND FORCE

- ☑ Transducers & Strain Gages
- ☑ Load Cells & Pressure Gages
- ☑ Displacement Transducers
- ☑ Instrumentation & Accessories

FLOW/LEVEL

- ☑ Rotameters, Gas Mass Flowmeters & Flow Computers
- ☑ Air Velocity Indicators
- ☑ Turbine/Paddlewheel Systems
- ☑ Totalizers & Batch Controllers

pH/CONDUCTIVITY

- ☑ pH Electrodes, Testers & Accessories
- ☑ Benchtop/Laboratory Meters
- ☑ Controllers, Calibrators, Simulators & Pumps
- ☑ Industrial pH & Conductivity Equipment

DATA ACQUISITION

- ☑ Communications-Based Acquisition Systems
- ☑ Data Logging Systems
- ☑ Wireless Sensors, Transmitters, & Receivers
- ☑ Signal Conditioners
- ☑ Data Acquisition Software

HEATERS

- ☑ Heating Cable
- ☑ Cartridge & Strip Heaters
- ☑ Immersion & Band Heaters
- ☑ Flexible Heaters
- ☑ Laboratory Heaters

ENVIRONMENTAL MONITORING AND CONTROL

- ☑ Metering & Control Instrumentation
- ☑ Refractometers
- ☑ Pumps & Tubing
- ☑ Air, Soil & Water Monitors
- ☑ Industrial Water & Wastewater Treatment
- ☑ pH, Conductivity & Dissolved Oxygen Instruments