

22MM METAL ROUND ACTUATOR: SELECTOR SWITCH
 MOMENTARY CONTACT TYPE 3 SWITCH POSITIONS I-O-II NON-
 ILLUMINATED WITH HOLDER BLACK !!! Phased-out product !!!
 SIRIUS ACT 3SU1 is successor Preferred successor type is
 >>3SU1052-2BM60-0AA0 + 3SU1550-0AA10-0AA0<<



Figure similar

Design of the product	Single device round
Enclosure	
Number of command points	1
Actuator	
Design of the operating mechanism	selector switch
Manner of function of the actuating element	Momentary contact type
Product extension optional Light source	No
Color	
• of the actuating element	black
Material of the actuating element	plastic
Outer diameter of the actuating element	28.5 mm
Type of unlocking device	without
Number of switching positions	3
Actuating angle	
• clockwise	50°
• anticlockwise	50°

Front ring	
Product component front ring	Yes
Design of the front ring	Standard
Material of the front ring	metal
Color of the front ring	silver

Holder	
Material of the holder	Metal





General technical data	
Product function	
<ul style="list-style-type: none"> EMERGENCY OFF function EMERGENCY STOP function 	No
Protection class IP	IP67
Vibration resistance	
<ul style="list-style-type: none"> acc. to IEC 60068-2-6 	20 ... 200 Hz: 5g
Operating frequency maximum	1 000 1/h
Mechanical service life (switching cycles)	
<ul style="list-style-type: none"> typical 	300 000
Reference code acc. to DIN 40719 extended according to IEC 204-2 acc. to IEC 750	S



Connections/Terminals	
Tightening torque of the screws in the bracket	1.4 ... 1.6 N·m

Ambient conditions	
Ambient temperature	
<ul style="list-style-type: none"> during operation during storage 	-25 ... +70 °C -40 ... +80 °C
Environmental category during operation acc. to IEC 60721	3K6

Installation/ mounting/ dimensions	
Mounting type	front mounting
Shape of the installation opening	round
Mounting diameter	22 mm
Mounting height	24 mm
Installation width	28.5 mm
Installation depth	29 mm

Certificates/approvals	
------------------------	--

General Product Approval			Declaration of Conformity	Test Certificates	Marine / Shipping
				Special Test Certificate	
CSA	UL		EG-Konf.		ABS

Marine / Shipping			other		
			Confirmation	Environmental Confirmations	Miscellaneous
LRS	PRS	RINA			

Further information

Information- and Downloadcenter (Catalogs, Brochures,...)

<http://www.siemens.com/industrial-controls/catalogs>

Industry Mall (Online ordering system)

<https://mall.industry.siemens.com/mall/en/en/Catalog/product?mlfb=3SB3500-2EA11>

Cax online generator

<http://support.automation.siemens.com/WW/CAXorder/default.aspx?lang=en&mlfb=3SB3500-2EA11>

Service&Support (Manuals, Certificates, Characteristics, FAQs,...)

<https://support.industry.siemens.com/cs/ww/en/ps/3SB3500-2EA11>

Image database (product images, 2D dimension drawings, 3D models, device circuit diagrams, EPLAN macros, ...)

http://www.automation.siemens.com/bilddb/cax_de.aspx?mlfb=3SB3500-2EA11&lang=en

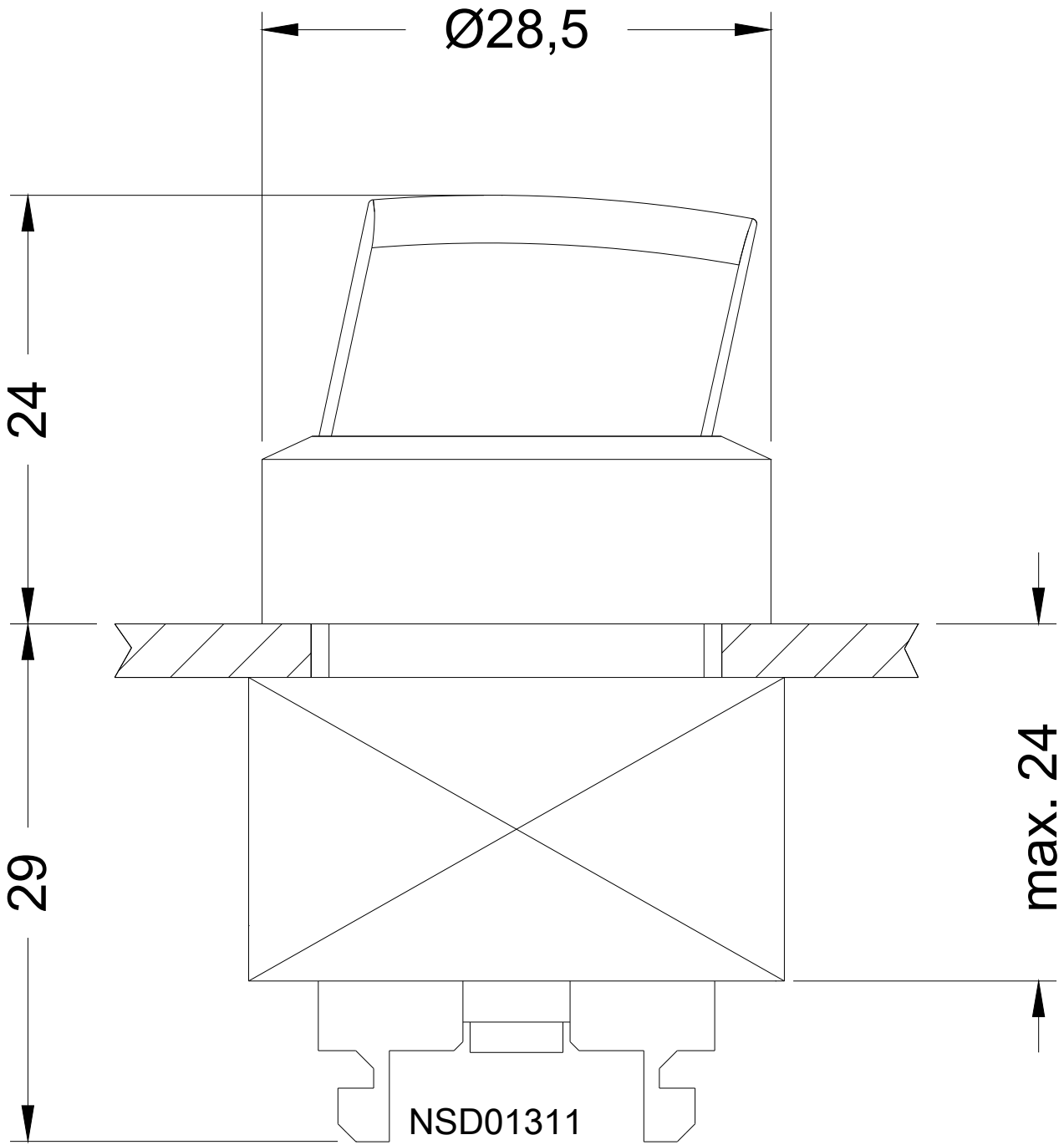

last modified:

09/25/2018