

Data sheet | Item number: 221-413

COMPACT splicing connector; 3-conductor; with operating levers;
transparent housing

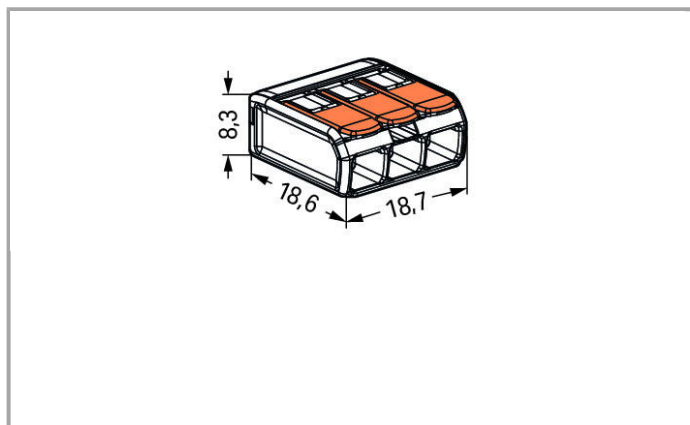

www.wago.com/221-413



Data

Electrical data

Ratings per IEC/EN 60664-1

Rated voltage (II / 2)	450 V
Rated impulse voltage (II / 2)	4 kV



Rated current	32 A
Legend (ratings)	(II / 2) ≙ Overvoltage category II / Pollution degree 2

Connection data

Connection technology	CAGE CLAMP®
Actuation type	Lever
Connectable conductor materials	Copper
Nominal cross section	4 mm ²
Solid conductor	0.2 ... 4 mm ² / 24 ... 12 AWG
Stranded conductor	0.2 ... 4 mm ² / 24 ... 12 AWG
Fine-stranded conductor	0.14 ... 4 mm ² / 24 ... 12 AWG
Strip length	11 mm / 0.43 Inch
Total number of connection points	3
Total number of potentials	1
Type of wiring	Side-entry wiring

Geometrical Data

Width	18.7 mm / 0.736 inch
Height	8.3 mm / 0.327 inch
Depth	18.6 mm / 0.732 inch

Material Data

Color	transparent
Flammability class per UL94	V2
Weight	2.527 g

Environmental Requirements

Surrounding air (operating) temperature	85 °C
T-Marking per EN 60998	T85

Commercial data

Country of origin	DE
GTIN	4050821808442
Product Group	7 (Push Wire Conn.)



Approvals / Certificates

Country specific Approvals

Logo	Approval	Certificate name
	CCA DEKRA Certification B.V.	71-101731



Ship Approvals



Logo	Approval	Certificate name
	ABS American Bureau of Shipping	15-HG1419918-PDA
	DNV GL Det Norske Veritas, Germanischer Lloyd	TAE000015T
	LR Lloyds Register	04/20013 (E6)

UL-Approvals

Logo	Approval	Certificate name
	UL UL International Germany GmbH	E69654

Compatible products

Mounting adapter

	Item no.: 221-500 Mounting carrier; for 221 series COMPACT splicing connectors; orange	www.wago.com/221-500
	Item no.: 222-505 Strain relief plate; for 221-500 or 222-500 mounting carrier; snap on; orange	www.wago.com/222-505
	Item no.: 222-510 Angled DIN-rail adapter; for 221-500 or 222-500 mounting carrier; gray	www.wago.com/222-510

Downloads

Documentation

Bid Text

221-413	Mar 9, 2018	DOC 25.6 kB	Download
---------	-------------	----------------	----------



CAD files

CAD data

3D Download 221-413

URL

Download

Subject to changes.

WAGO Corporation
Germantown, WI 53022
32423 Minden
Phone: +49571 887-0 | Fax: (262) 255-6222
Email: info.us@wago.com | Web: www.wago.com

Do you have any questions about our products?
We are always happy to take your call at {0}.