

CREALITY

Junior 3D printer

Ender-3 Pro



Quick reply within 2 hours



One-on-one service



1 year warranty



Lifelong remote assistance

Which function we have?



Enhance printing stability



Newly Soft magnetic sticker



MeanWell Power supply



DIY assembly

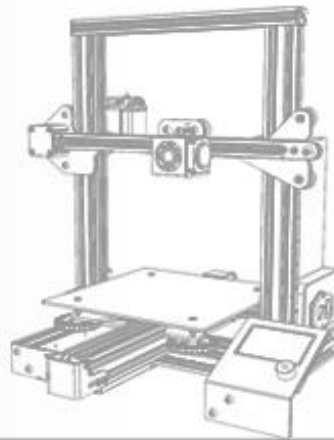

Heating up with only
5 minutes



Print with high precision



Easier to level



Resume printing
while power-off

Overall parameter list

Model	Ender-3 Pro
Printing Method	FDM (Fused Deposition Molding)
Printing Size	220*220*250mm
Printing Speed	±0.1mm
Nozzle Diameter	Standard0.4mm,can be in 0.2,0.3mm
Bed Temp.	≤110℃
Working Mode	Online or SD card offline
File Format	STL,obj,amf
Slice Software	Cura, Repetier-Host ,Simplify3D
Power Supply	Input:AC 100-120V/6.8A 200-240V/3.4A 50/60Hz Output:DC 24V 270W
Filament	1.75mm PLA,ABS,Wood,TPU,gradient color,carbon fiber,etc.
N.W.	6.9kg
Machine Size	440*440*465mm
G.W.	8.9kg
Package Size	595*495*165mm



DIY assembly

Enjoy more fun of DIY, easier to realize the innovative transformation of the appearance and meet more of your printing needs.

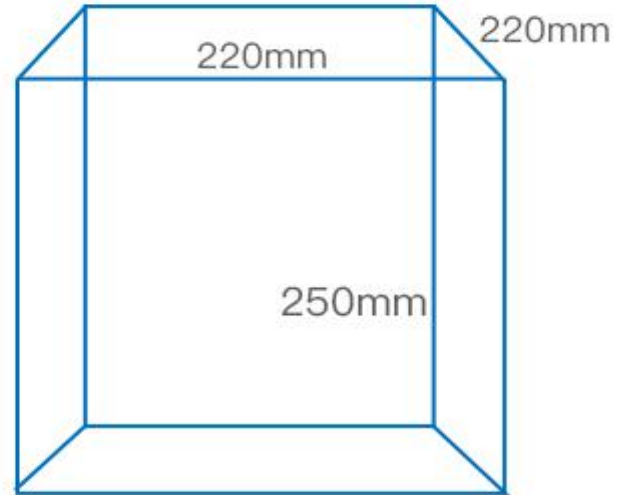

Extruder

Patent Technology 1: MK-10 Extrusion mechanism, reducing the risk of plugging and spillage.

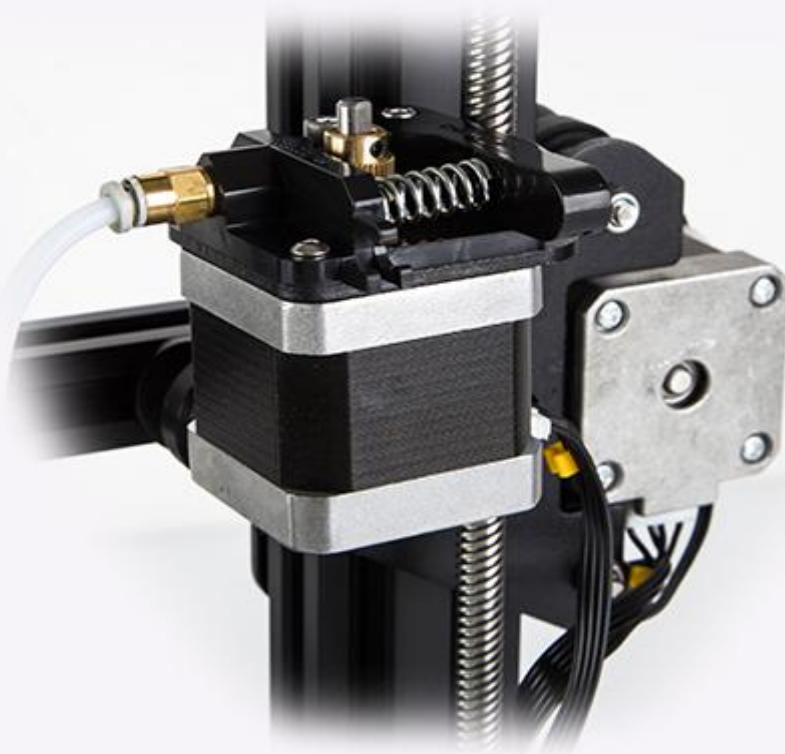

Patent No.: 2016200045384

High Standard Structure

Patent Technology 2: The V-profile pulley moves more stable and smoothly, with low noise and wear resistance.



Patent No.: [ZL 2015 2 0331477.8](https://patent.com.cn/patent/zn/zl2015203314778.shtml)

New platform sticker

Magnetic sticker, which can better adhere to the platform than textured paper and glue. easier to remove the model and solve the printing edge problem, more cost-effective.



Resume printing while power-off

Safely protect the power supply, with this function, can help achieving long-time printing.

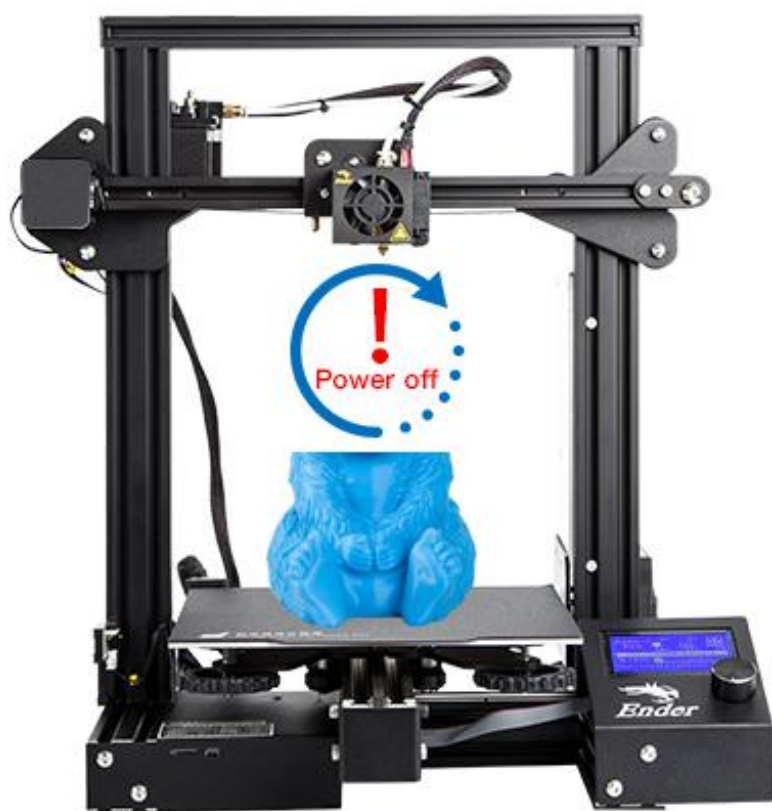

Finish continue printing

Rapid heating

Only takes 5 minutes, the heated bed can reach up the 110 degree, quite meet the requirement of printing various of filaments.



High precision

CNC machining Y-axis mounting groove, precise positioning,
stable structure for better printing.



Simple leveling method

Larger hand-turn nut, ergonomic design, enabling to level the platform more quickly.

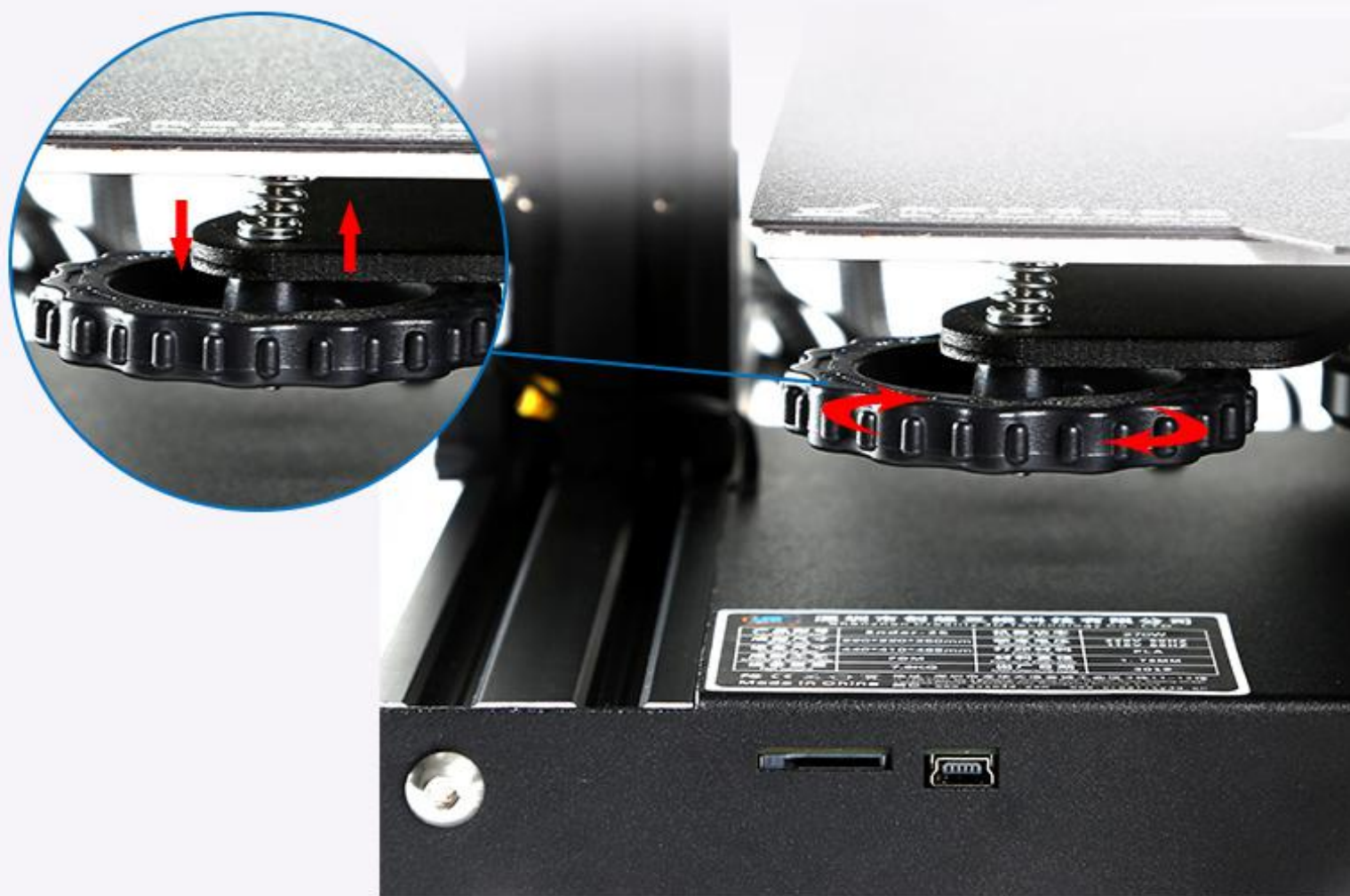

Stable power supply

Meanwell power supply, which made by the listed company over 30 years, mature technology, provide you the best user experience and worth trying.



Free big kit package for you



Pliers



Nozzle



SD card



Pneumatic fittings



Cable tie



Blade



Allen key



Needle for nozzle



Wrench



Screw Driver



Rack



PTFE Tube

Humanized design

Portable knob / print with one button



Oversized nuts design

Oversized nuts design for more better levelling

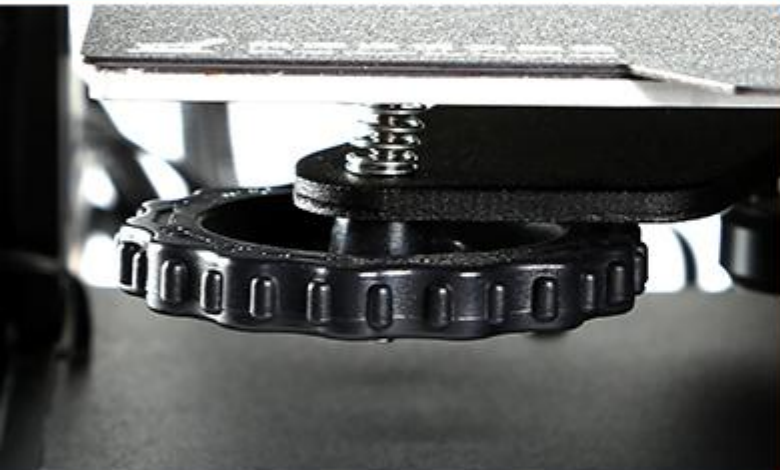

Easy to remove

Ergonomics, more convenient to demolish



3D printing application field



Lighting Design



Architectural Design



Medical Hygiene



Movie props

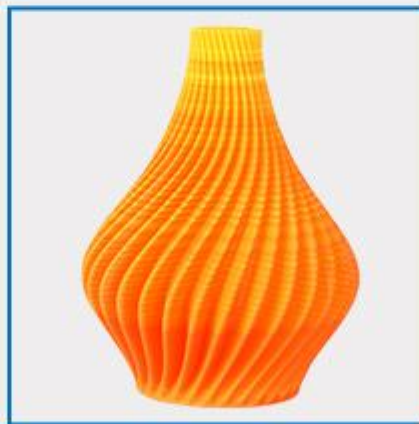

Furniture



3D Portrait

More fields are waiting for you to discover.....

Scenes Display

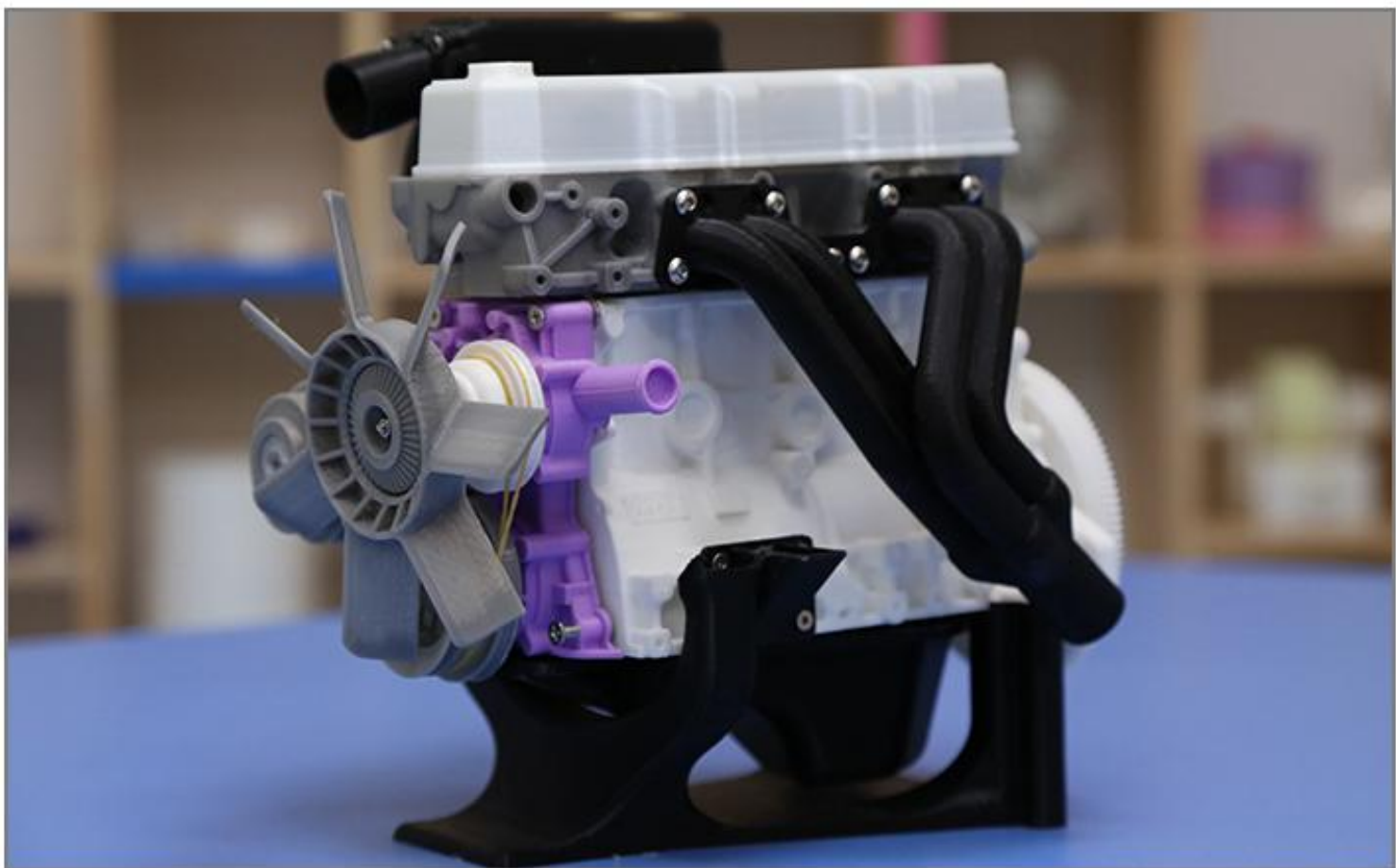
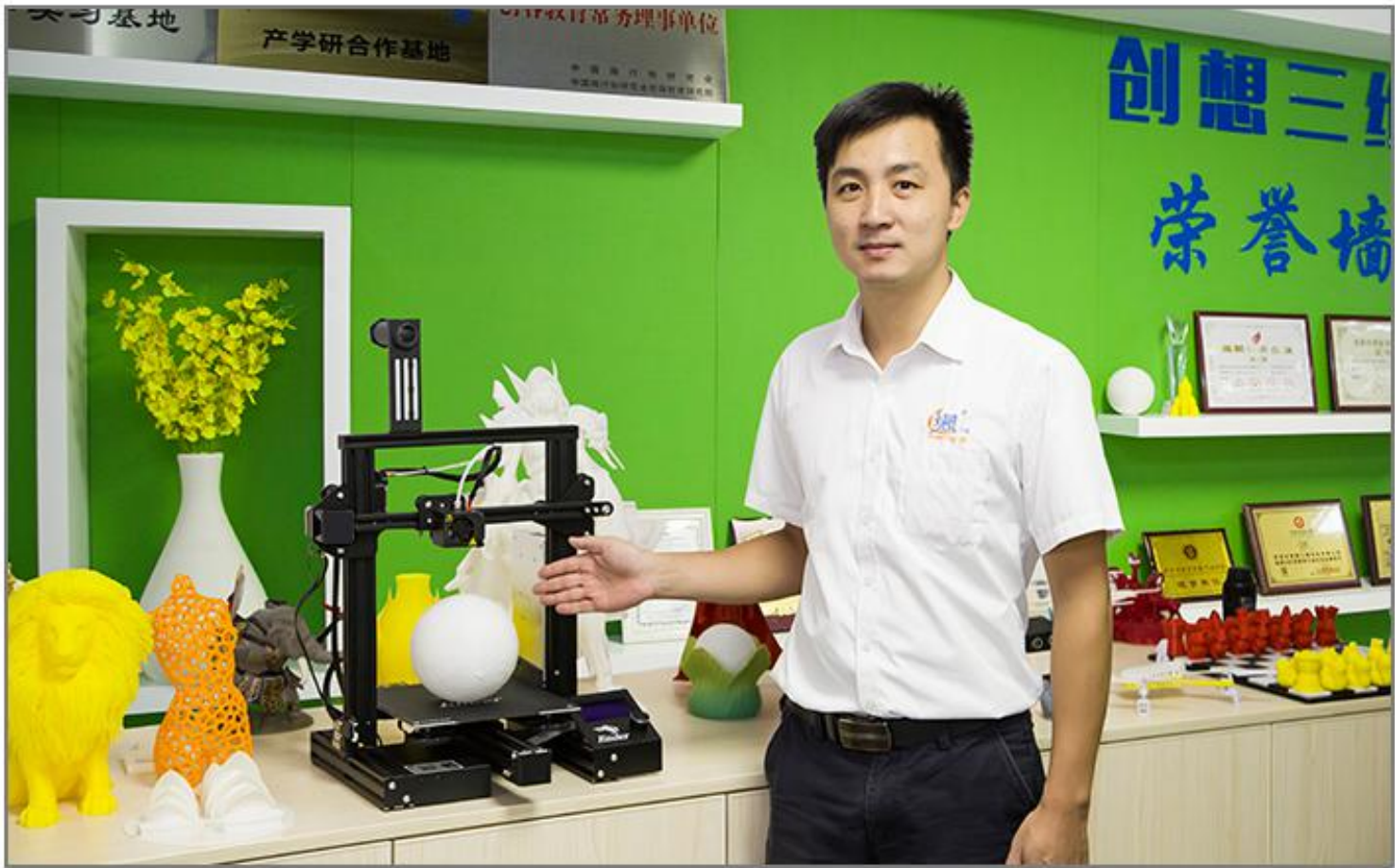

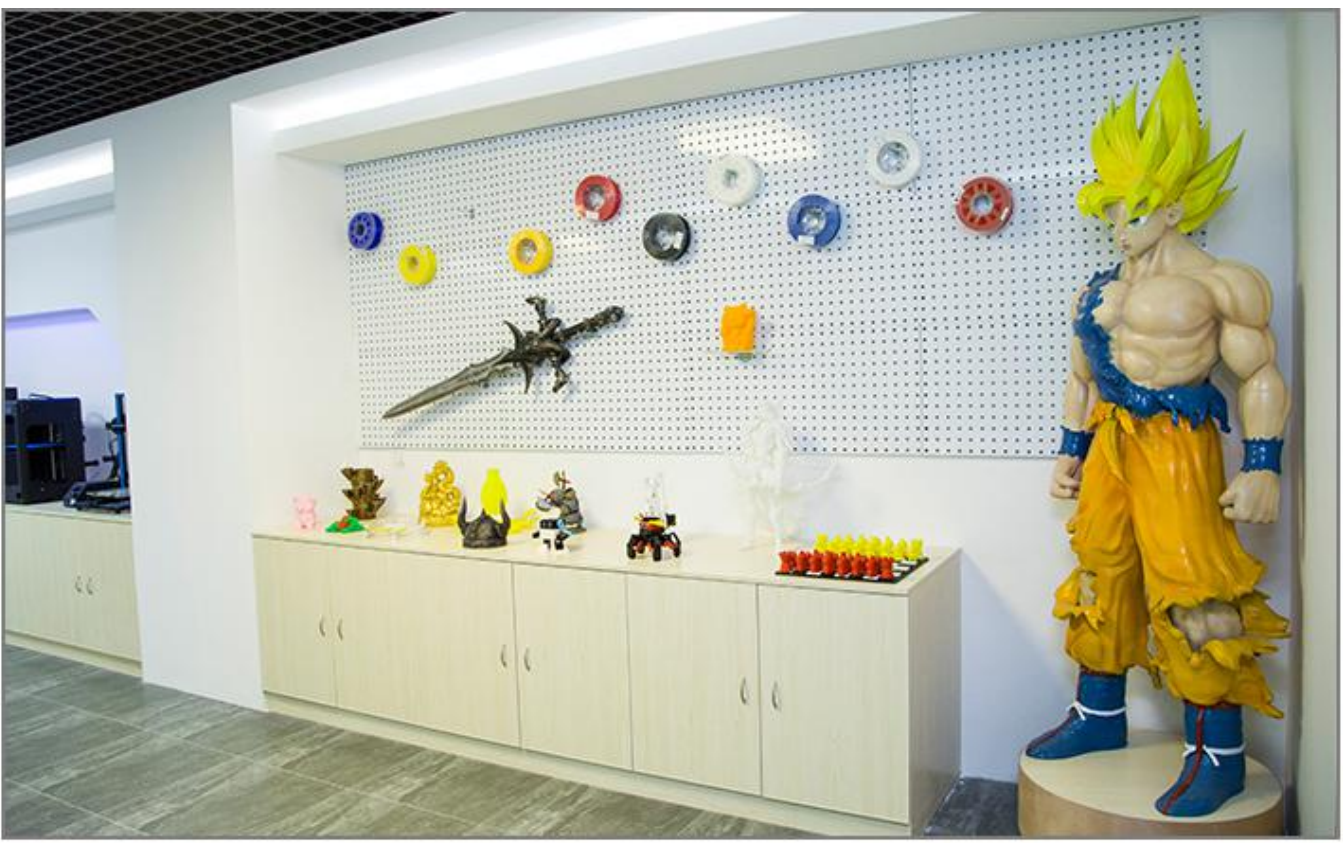

Product Display





COMPANY STRENGTH



Make every part with your heart

Always chase better, never fall behind

Creality 3d always committed to continuously improving the production of 3D printers with higher technology capabilities.



Brand Culture

Founded in 2014, Shenzhen Chuangxiang 3D Technology Co., Ltd. is an R&D manufacturer in the 3D printing industry in China, dedicated to building 3D

Creakuty 3D will develop 3D printing and the Internet at the same time in the future development, continuously innovate in technology, and continuously optimize product lines.

Committed to creating a special 3D printing production kingdom, to meet your imagination of three-dimensional molding, so that your dreams are possible.

People enjoy the convenience brought by 3D printing technology.

