

PLEASE CHECK WWW.MOLEX.COM FOR LATEST PART INFORMATION

Part Number: [0512811294](#)
Status: **Active**
Overview: [FFC-FPC \(SMT\)](#)
Description: 0.50mm Pitch Easy-On FFC/FPC Connector, Surface Mount, Right-Angle, Non-ZIF, Dual Contact Style, 1.20mm Mated Height, 12 Circuits, Gold (Au) Plating

Documents:

[3D Model](#) [Packaging Specification SPK-51281-001-001 \(PDF\)](#)
[Drawing \(PDF\)](#) [RoHS Certificate of Compliance \(PDF\)](#)
[Product Specification PS-51281-003-001 \(PDF\)](#)

General

Product Family [FFC/FPC Connectors](#)
Series [51281](#)
Overview [FFC-FPC \(SMT\)](#)
Product Name [Easy-On](#)
UPC [822348700042](#)

Physical

Actuator Type [Non-ZIF](#)
Circuits (Loaded) [12](#)
Color - Resin [Natural](#)
Contact Position [Dual](#)
Durability (mating cycles max) [20](#)
Mated Height [1.20mm](#)
Material - Metal [Phosphor Bronze](#)
Material - Plating Mating [Gold](#)
Material - Plating Termination [Tin](#)
Net Weight [80.536/mg](#)
Number of Rows [1](#)
Orientation [Right Angle](#)
PCB Locator [No](#)
PCB Mounting [Surface Mount](#)
PCB Retention [Yes](#)
Packaging Type [Embossed Tape on Reel](#)
Pitch - Mating Interface [0.50mm](#)
Plating min - Mating [0.102µm](#)
Plating min - Termination [1.016µm](#)
Polarized to PCB [Yes](#)
Stackable [No](#)
Surface Mount Compatible (SMC) [N/A](#)
Temperature Range - Operating [-20° to +85°C](#)
Wire/Cable Type [FFC/FPC](#)

Electrical

Current - Maximum per Contact [0.5A](#)
Voltage - Maximum [50V](#)

Material Info

Reference - Drawing Numbers

[Packaging Specification](#) [SPK-51281-001-001](#)
[Product Specification](#) [PS-51281-003-001](#)
[Sales Drawing](#) [SD-51281-011, SD-51281-012](#)

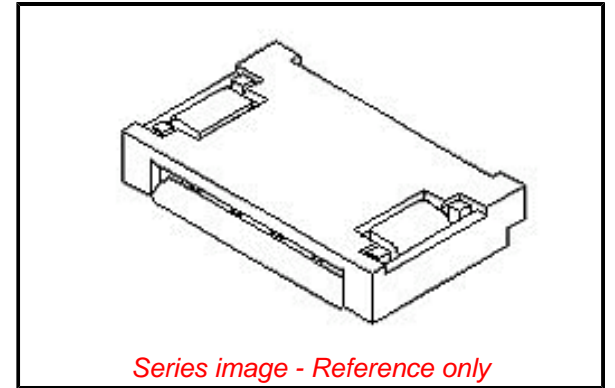

EU ELV

Not Relevant

EU RoHS

Compliant

REACH SVHC

Not Contained Per -
ED/61/2018 (27 June
2018)

Halogen-Free

Status

Low-Halogen

For more information, please visit [Contact US](#)

China ROHS

ELV

RoHS Phthalates

China RoHS

Green Image

Not Relevant

Not Contained

Search Parts in this Series

[51281 Series](#)

PLEASE CHECK WWW.MOLEX.COM FOR LATEST PART INFORMATION