

PLEASE CHECK WWW.MOLEX.COM FOR LATEST PART INFORMATION

Part Number: **0874391000**
Status: **Active**
Overview: Pico-SPOX Wire-to-Board Connector System
Description: 1.50mm Pitch Pico-SPOX Wire-to-Board Housing, 10 Circuits, Off-White Housing

Documents:

3D Model	Product Specification PS-87437-001-001 (PDF)
Drawing (PDF)	Packaging Specification SPK-87439-001-001 (PDF)
Product Specification 2027050000-000 (PDF)	RoHS Certificate of Compliance (PDF)
Product Specification PS-78047-001-001 (PDF)	Product Literature (PDF)

Agency Certification

CSA	LR19980
UL	E29179

General

Product Family	Crimp Housings
Series	87439
Application	Signal, Wire-to-Board
Overview	Pico-SPOX Wire-to-Board Connector System
Product Literature Order No	USA-235
Product Name	Pico-SPOX
UPC	800753751897

Physical

Circuits (maximum)	10
Color - Resin	Natural
Flammability	94V-0
Gender	Receptacle
Glow-Wire Capable	No
Lock to Mating Part	Yes
Material - Resin	Nylon
Net Weight	0.120/g
Number of Rows	1
Packaging Type	Bag
Panel Mount	No
Pitch - Mating Interface	1.50mm
Polarized to Mating Part	Yes
Stackable	No
Temperature Range - Operating	-55° to +105°C

Electrical

Current - Maximum per Contact	2.5A
-------------------------------	------

Material Info

Reference - Drawing Numbers

Packaging Specification	SPK-87439-001-001
Product Specification	2027050000-000, PS-78047-001-001, PS-87437-001-001
Sales Drawing	SD-87439-**00

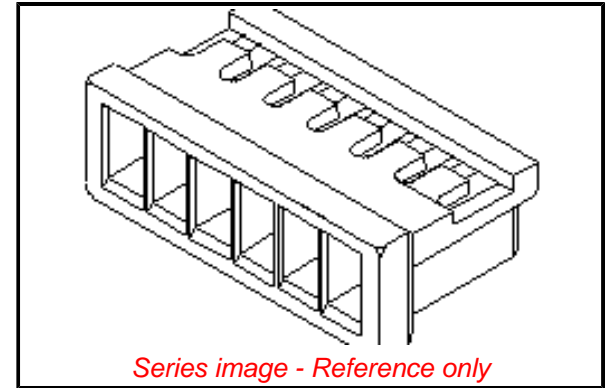

EU ELV

Not Relevant

EU RoHS

Compliant

REACH SVHC

Not Contained Per - ED/61/2018 (27 June 2018)

Halogen-Free

Status

Low-Halogen

For more information, please visit [Contact US](#)

China ROHS

ELV

RoHS Phthalates

China RoHS

Green Image

Not Relevant

Not Contained

Search Parts in this Series

[87439](#) Series

Mates With

Pico-SPOX Wire-to-Board Header [87437](#) , [87438](#)

Use With

[87421](#) Pico-SPOX Crimp Terminal