

Power Inductors

Model HA72L-0420 series



Features:

- Operating Temperature Range -55°C to $+155^{\circ}\text{C}$
- Ambient Temperature, Maximum $+115^{\circ}\text{C}$
- Temperature Rise, 40°C
- RoHS Compliant
- AEC-Q200 Certified

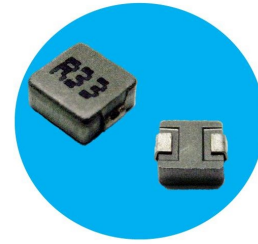

 All parts are Pb-free and comply with EU Directive 2011/65/EU (RoHS2)

Schematic

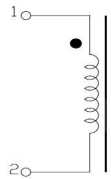

Specifications @ 25°C

Part Number	Inductance ($\mu\text{H} \pm 20\%$ @0A)	DCR ($\text{m}\Omega$) Typ	DCR ($\text{m}\Omega$) Max	Irms (A)	Isat (A)	Part Number	Inductance ($\mu\text{H} \pm 20\%$ @0A)	DCR ($\text{m}\Omega$) Typ.	DCR ($\text{m}\Omega$) Max	Irms (A)	Isat (A)
HA72L-0420R10LFTR	0.10	3.5	4.0	12.0	22.0	HA72L-04201R5LFTR	1.50	38.0	46.0	4.0	6.0
HA72L-0420R22LFTR	0.22	6.0	6.6	9.0	12.5	HA72L-04202R2LFTR	2.20	52.0	58.0	3.0	5.0
HA72L-0420R33LFTR	0.33	9.6	13.0	8.0	12.0	HA72L-04203R3LFTR	3.30	74.0	87.0	2.5	4.0
HA72L-0420R47LFTR	0.47	12.5	14.0	7.0	9.5	HA72L-04204R7LFTR	4.70	98.0	110.0	2.0	3.5
HA72L-0420R56LFTR	0.56	14.0	16.0	6.5	10.0	HA72L-04205R6LFTR	5.60	105.0	115.0	1.8	3.0
HA72L-0420R68LFTR	0.68	16.0	18.0	6.0	9.0	HA72L-04206R8LFTR	6.80	160.0	175.0	1.5	2.5
HA72L-04201R0LFTR	1.00	24.0	27.0	4.5	7.0	HA72L-0420100LFTR	10.0	256.0	282.0	1.2	2.2
HA72L-04201R2LFTR	1.20	24.0	27.0	4.5	7.0						

- Notes: (1) Isat is the saturation current at which inductance rolls off approximately 30% from its initial (zero DC)
 (2) Irms is the approximate current at which $\Delta T = 40^{\circ}\text{C}$
 (3) Operating Temperature Range -55°C to $+155^{\circ}\text{C}$

General Note

TT Electronics reserves the right to make changes in product specification without notice or liability. All information is subject to TT Electronics' own data and is considered accurate at time of going to print.

TT Electronics | BI Technologies

A-1445, Jalan Tanjung Api
 25050 Kuantan Pahang Darul Makmur, Malaysia | Ph: +60 9 565 8888
www.ttelectronicsmagnetics.com/customer-service-enquiry

Electrical Specifications @ 25°C

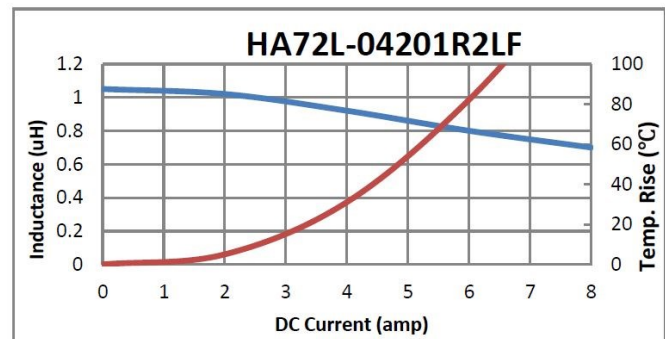
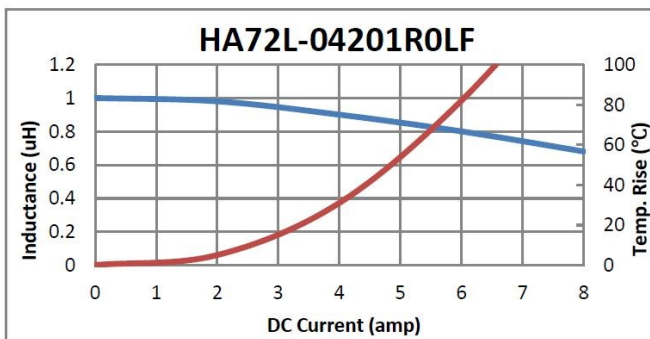
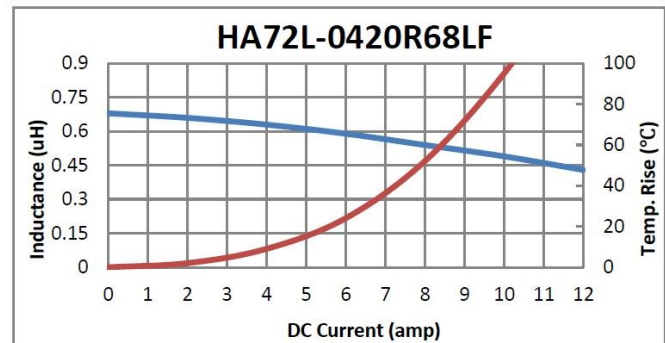
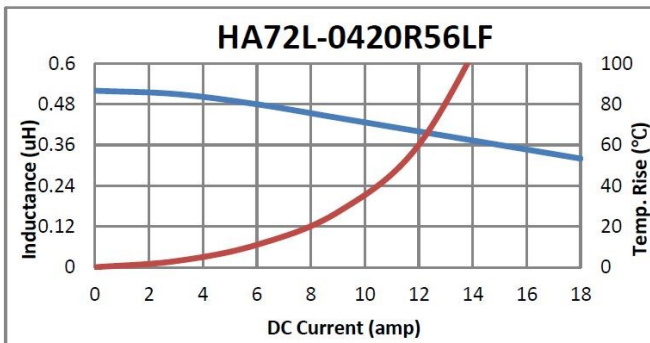
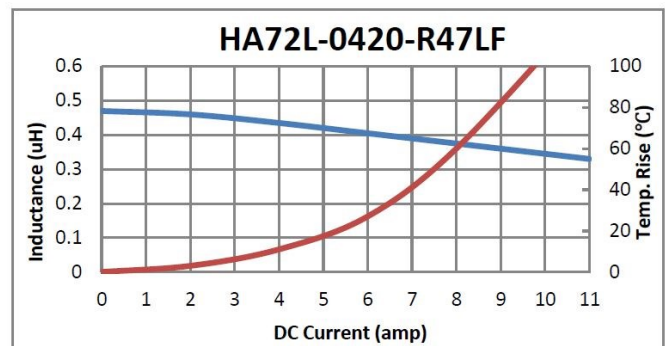
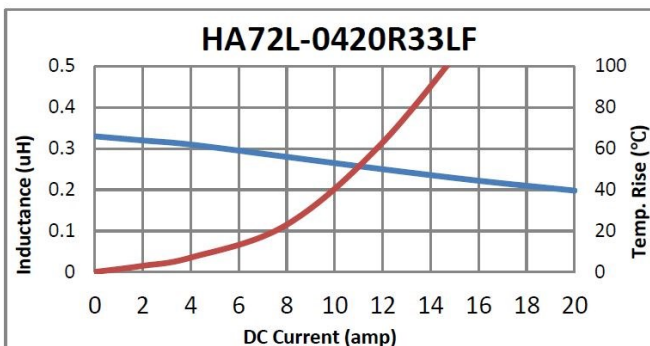
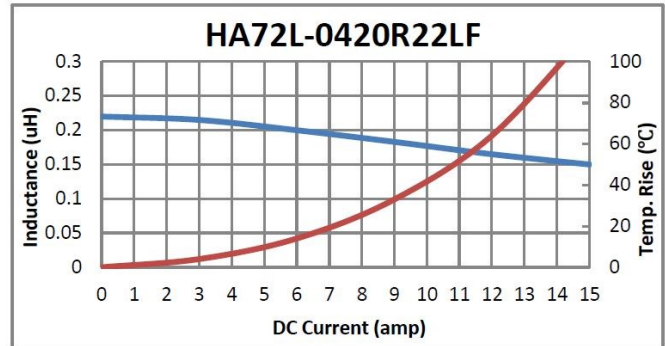
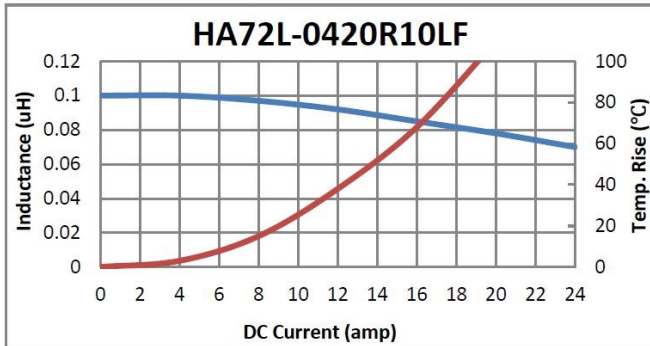

General Note
 TT Electronics reserves the right to make changes in product specification without notice or liability. All information is subject to TT Electronics' own data and is considered accurate at time of going to print.

TT Electronics | BI Technologies
 A-1445, Jalan Tanjung Api
 25050 Kuantan Pahang Darul Makmur, Malaysia | Ph: +60 9 565 8888
www.ttelectronicsmagnetics.com/customer-service-enquiry

Electrical Characteristics @ 25°C

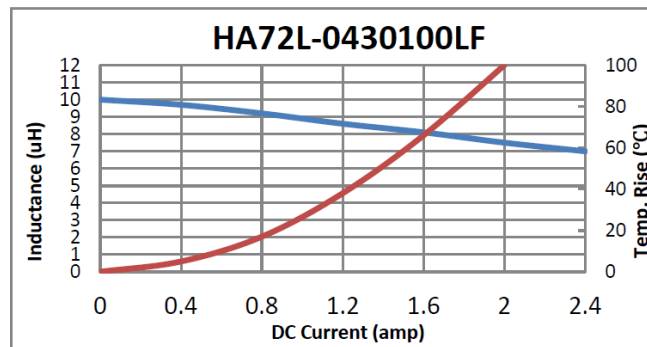
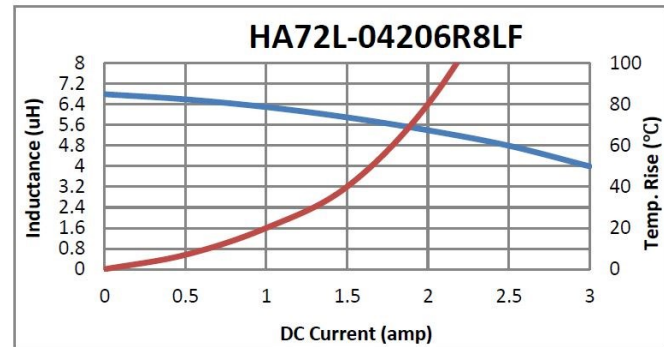
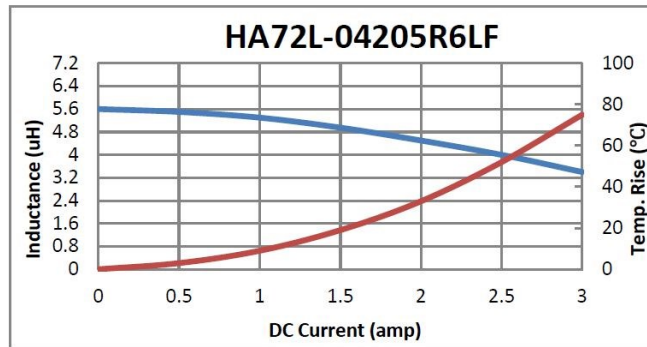
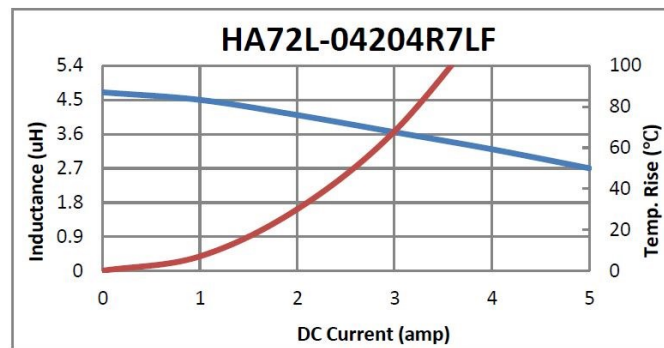
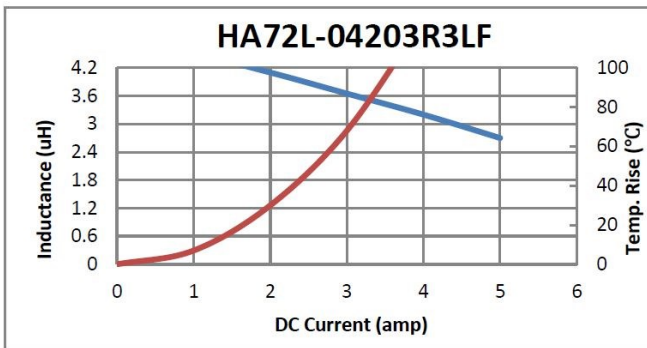
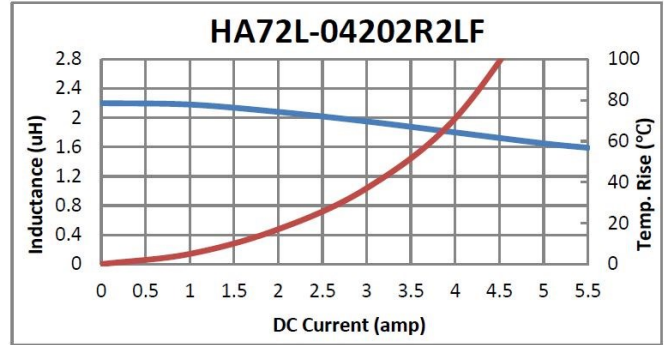
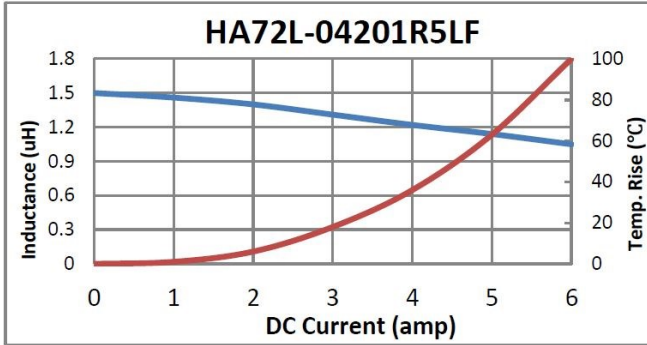

General Note
 TT Electronics reserves the right to make changes in product specification without notice or liability. All information is subject to TT Electronics' own data and is considered accurate at time of going to print.

TT Electronics | BI Technologies
 A-1445, Jalan Tanjung Api
 25050 Kuantan Pahang Darul Makmur, Malaysia | Ph: +60 9 565 8888
www.ttelectronicsmagnetics.com/customer-service-enquiry

Outline dimensions (mm)

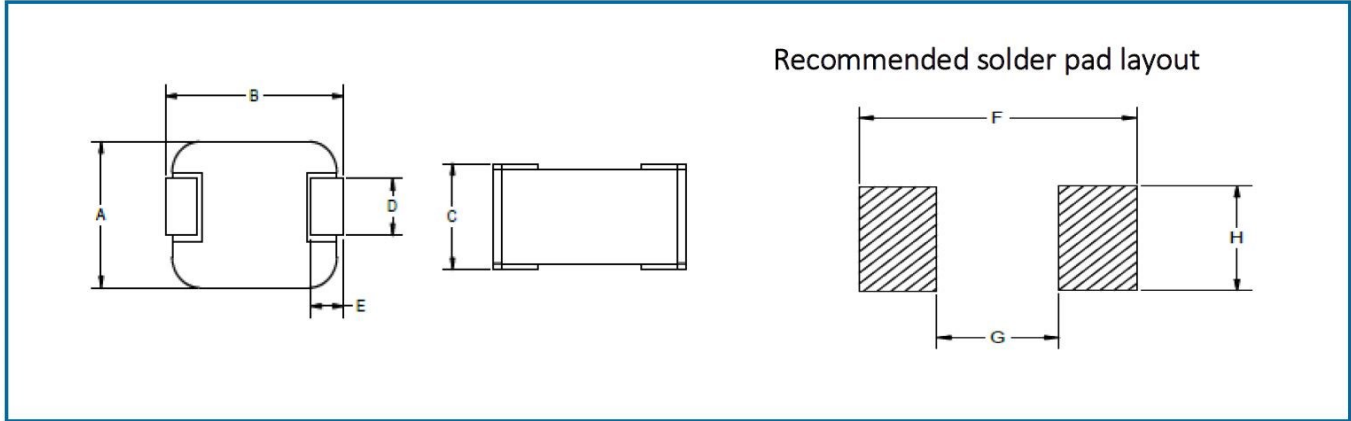

CASE SIZE	A(mm)	B(mm)	C(mm)	D(mm)	E(mm)	F(mm)	G(mm)	H(mm)
0420 series	4.05 ± 0.25	4.45 ± 0.25	2	1.5 ± 0.3	0.8 ± 0.3	4.95	2.15	2.30

Packaging

Standard:	Embossed Tape and Reel			
	Reel:	Diameter	All case size	= 13" (330mm)
		Capacity	Case size 0420	= 2,000 units

Ordering information

