

Open Type Trimmer

Model 39



Features:

- 15 mm single turn
- Dust proof
- Carbon element
- RoHS compliant



Model Styles Available

Top Adjust	39P
Side Adjust	39W

Electrical

Resistance Range	100 to 1,000,000 Ohms
Standard Resistance Tolerance	± 30%, (±20% and ±10% available)
Input Voltage, Maximum	250 Vdc
Power rating, Watts	Linear :0.25W, others : 0.15W, at 50°C
End Resistance, Maximum	< 500K - 2 ohms and ≥ 500K - 1%
Actual Electrical Travel	250° ±20°
Insulation Resistance, Minimum	100 Megohms
Resolution	Essentially infinite
Contact Resistance Variation	5% Max.

Mechanical

Torque, Maximum	2 in. oz.
Weight, Approx.	0.01 oz.
Wiper Position	Approx. 50%

Environmental

Operating Temperature Range	-25°C to +70°C
Rotational Life, 500 Cycles	±3% ΔR
Load Life, 0.25W, 1000 Hours, 50°C	±5% ΔR
Resistance to Solder Heat	260°C for 3 sec.
Aqueous cleaning not recommended	

General Note

TT Electronics reserves the right to make changes in product specification without notice or liability. All information is subject to TT Electronics' own data and is considered accurate at time of going to print.

TT Electronics | BI Technologies
4200 Bonita Place, Fullerton, CA USA 92835-1053 | Ph: +1 714-447-2300
www.ttelectronics.com | sensors@ttelectronics.com

Open Type Trimmer

Model 39



Ordering Information

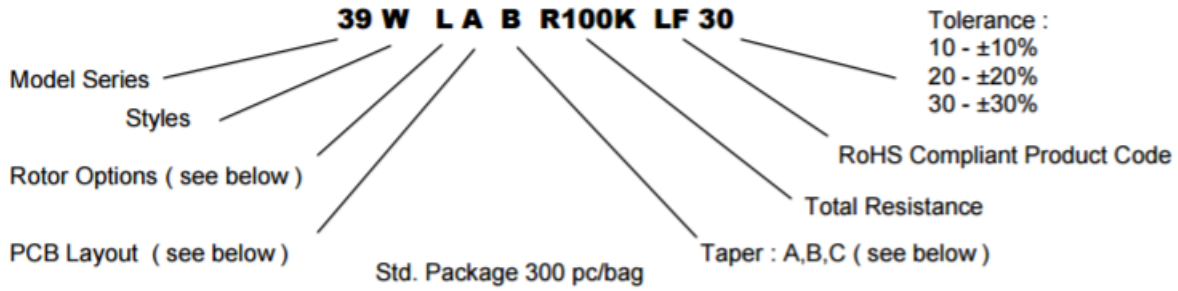

Rotor Options

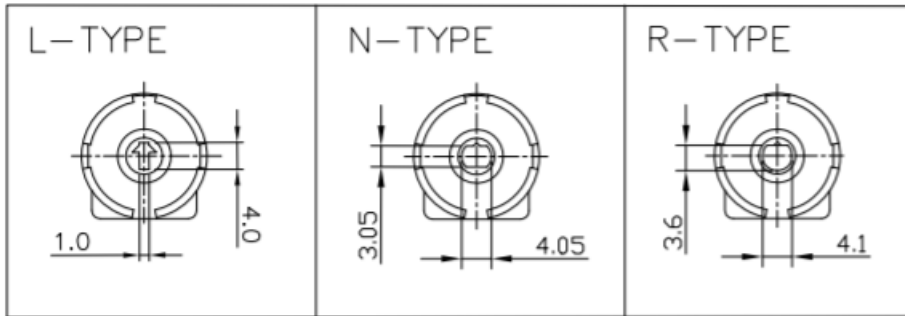

PCB Layout Options (39P)

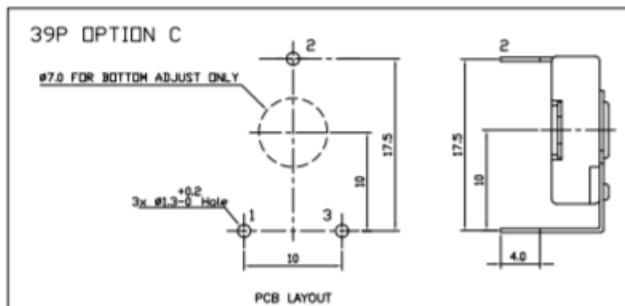
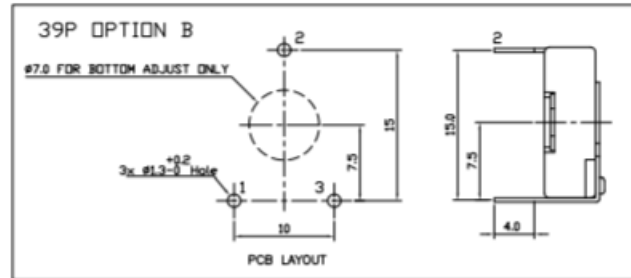
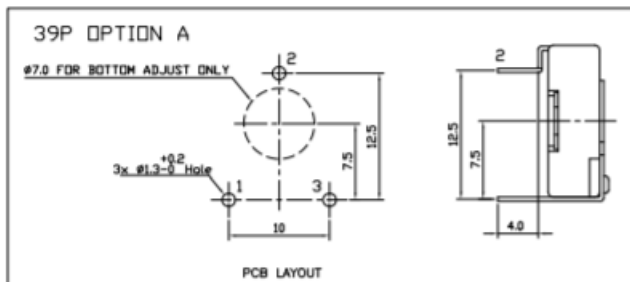

General Note
 TT Electronics reserves the right to make changes in product specification without notice or liability. All information is subject to TT Electronics' own data and is considered accurate at time of going to print.

TT Electronics | BI Technologies
 4200 Bonita Place, Fullerton, CA USA 92835-1053 | Ph: +1 714-447-2300
 www.ttelectronics.com | sensors@ttelectronics.com

Open Type Trimmer

Model 39



PCB Layout Options (39W)

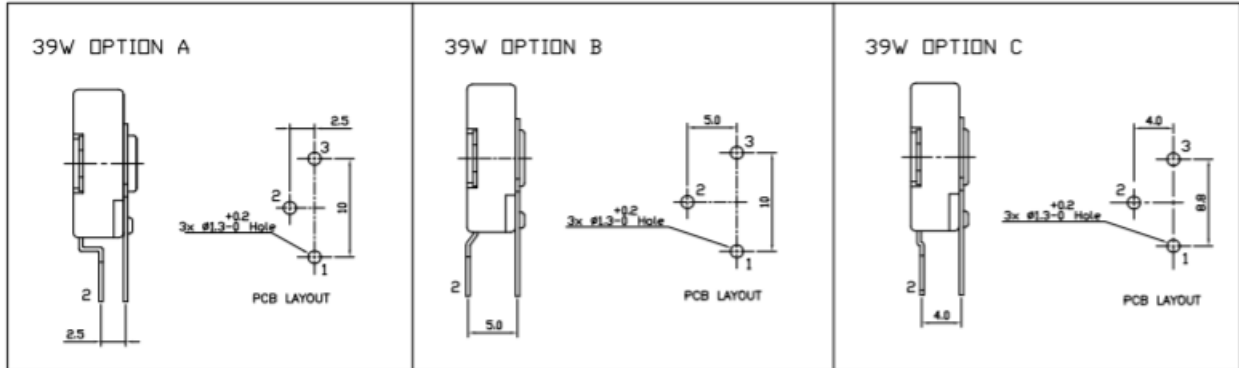

Taper Options

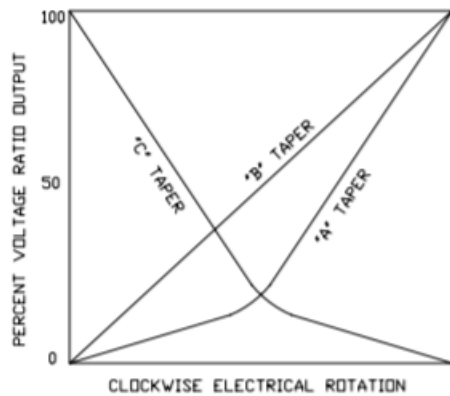

Circuit Diagram

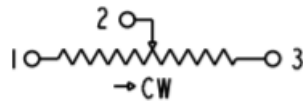

Standard Resistance Values, Ohms

100 500 1K 2K 5K 10K 20K 50K 100K 200K 500K 1MEG

General Note

TT Electronics reserves the right to make changes in product specification without notice or liability. All information is subject to TT Electronics' own data and is considered accurate at time of going to print.

TT Electronics | BI Technologies
4200 Bonita Place, Fullerton, CA USA 92835-1053 | Ph: +1 714-447-2300
www.ttelectronics.com | sensors@ttelectronics.com