

4G/LTE Ceramic Chip Antenna

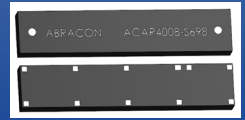

ACAR4008-S698



40.0 x 8.0 x 3.2 mm
RoHS/RoHS II Compliant
MSL = N/A

Features

- 4G/LTE full band coverage (700~960 MHz, 1710~2170 MHz, 2500~2700MHz)
- 2G/3G/GSM support
- Compact size
- Linear polarization

Applications

- IoT
- M2M
- 4G/LTE/3G/2G/GSM applications
- Telecommunications
- Networking
- Wireless modules
- Mobile devices
- Consumer electronics
- Broadband cellular connectivity
- Video and surveillance

Electrical Characteristics

Item	Spec
Working Frequency	700~960 MHz , 1710~2170 MHz , 2500~2700MHz
VSWR	< 4.0 (depends on the special environment)*
Polarization	Linear
Impedance	50 Ω
Operating Temperature	-40~85 °C
Termination	Ag (Environmentally-Friendly Pb Free)

* Evaluation board size 45.0 x 120.0 mm²

* Actual electrical value will depend on customer ground plane size

4G/LTE Ceramic Chip Antenna

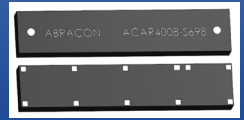

ACAR4008-S698



40.0 x 8.0 x 3.2 mm
RoHS/RoHS II Compliant
MSL = N/A

S11 Response Curve

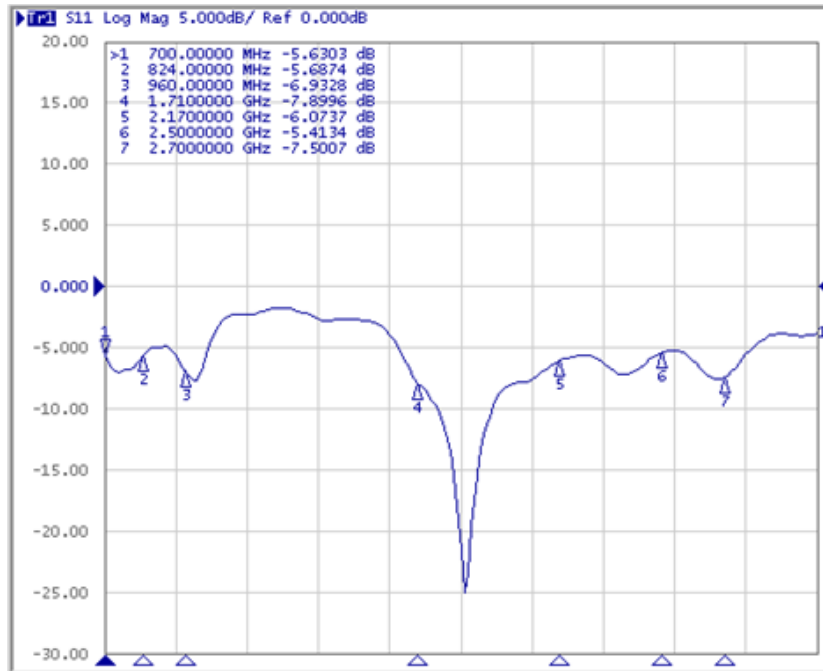

VSWR Response



4G/LTE Ceramic Chip Antenna

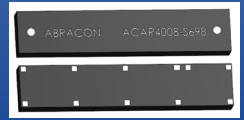

ACAR4008-S698



40.0 x 8.0 x 3.2 mm
RoHS/RoHS II Compliant
MSL = N/A

Smith Chart Response

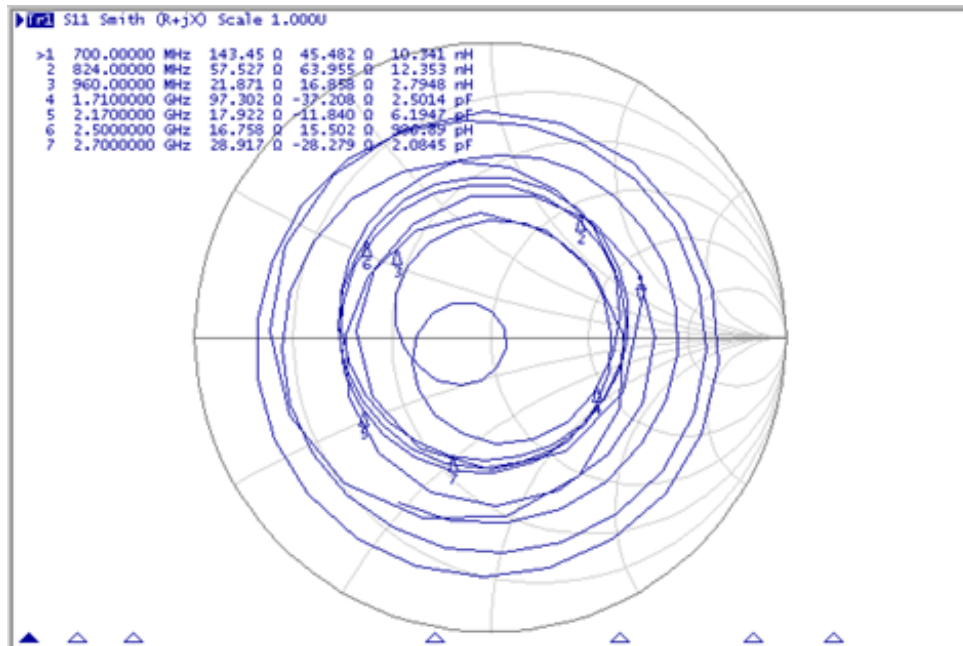

Gain and Efficiency

(Ground length: 105mm)

Antenna Parameter Summary										
Band	700	824	890	960	1710	1850	1990	2170	2500	2700
Peak Gain(dBi)	-1.55	0.1	0.33	-0.16	4.10	3.79	2.75	2.27	2.74	1.75
Efficiency(%)	35.78	56.34	58.14	50.82	73.61	75.01	69.64	55.96	69.45	68.84

Reference efficiency data with different ground plane length:

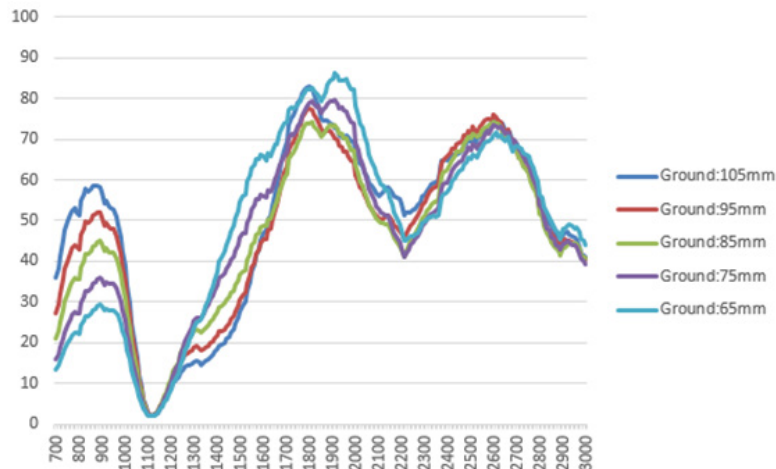

4G/LTE Ceramic Chip Antenna



ACAR4008-S698



40.0 x 8.0 x 3.2 mm
RoHS/RoHS II Compliant
MSL = N/A

3D Radiation Pattern

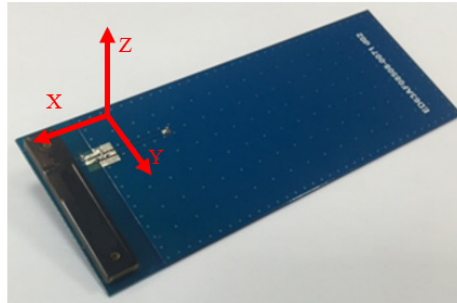

700MHz

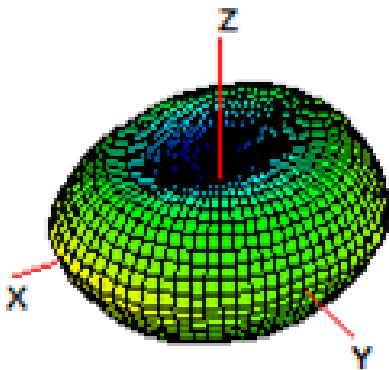

824MHz

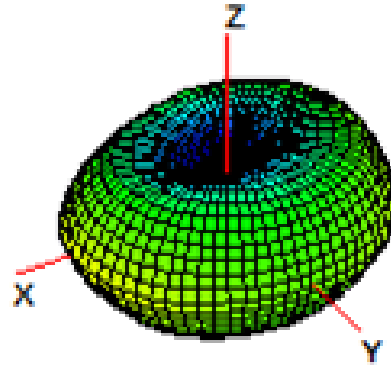

890MHz

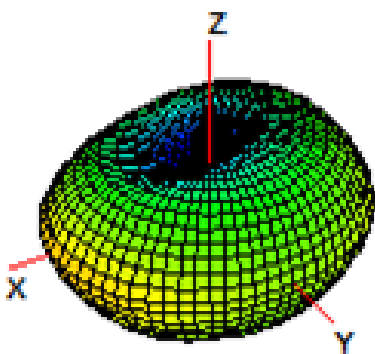

960MHz

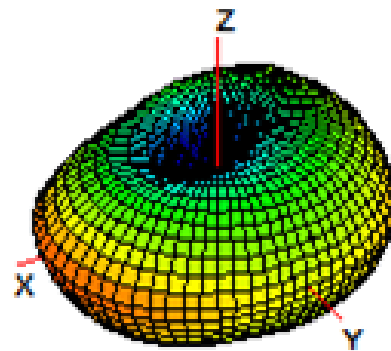

4G/LTE Ceramic Chip Antenna



ACAR4008-S698



40.0 x 8.0 x 3.2 mm
RoHS/RoHS II Compliant
MSL = N/A

3D Radiation Pattern

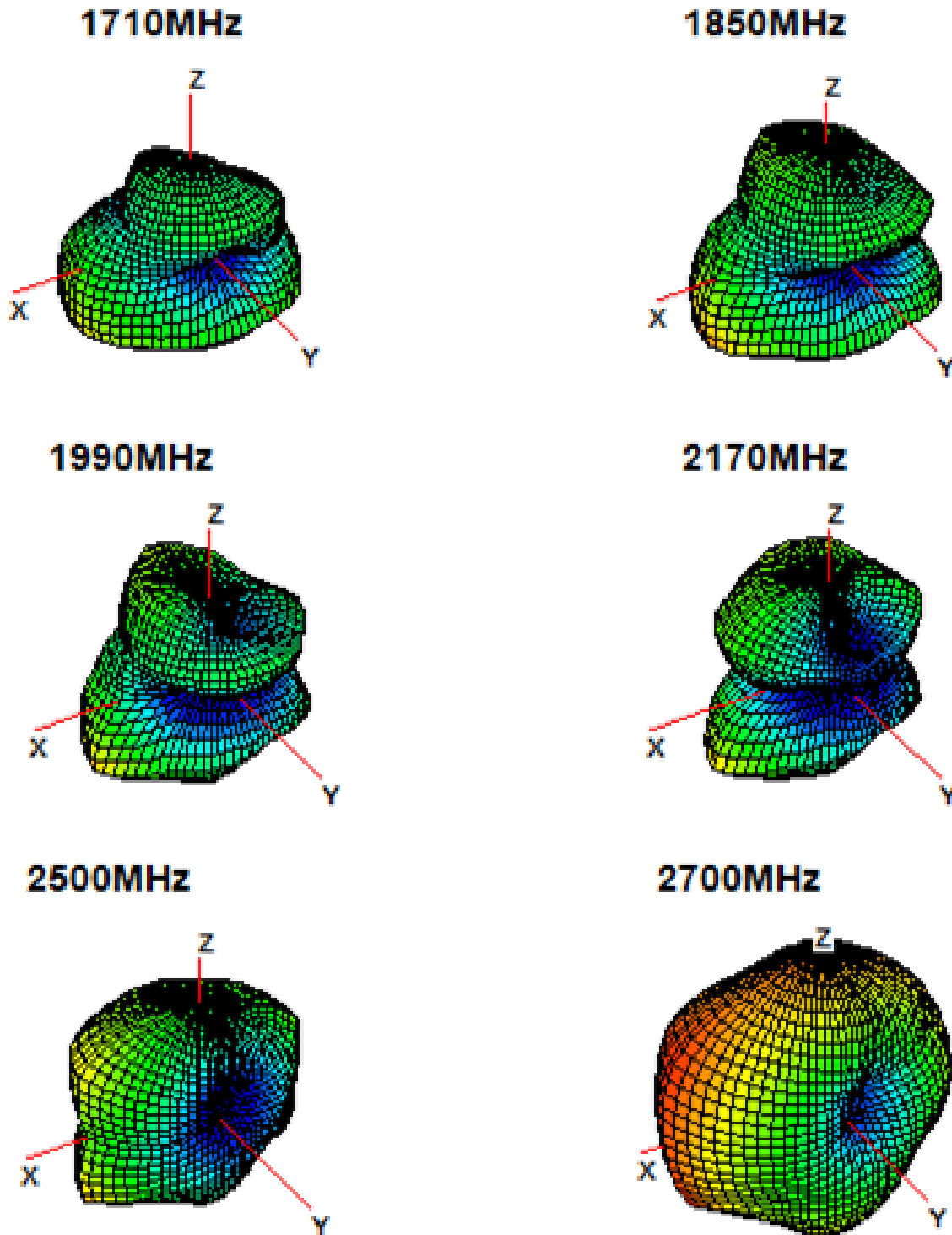

4G/LTE Ceramic Chip Antenna



ACAR4008-S698



40.0 x 8.0 x 3.2 mm
RoHS/RoHS II Compliant
MSL = N/A

Drawings

Shape and Dimensions

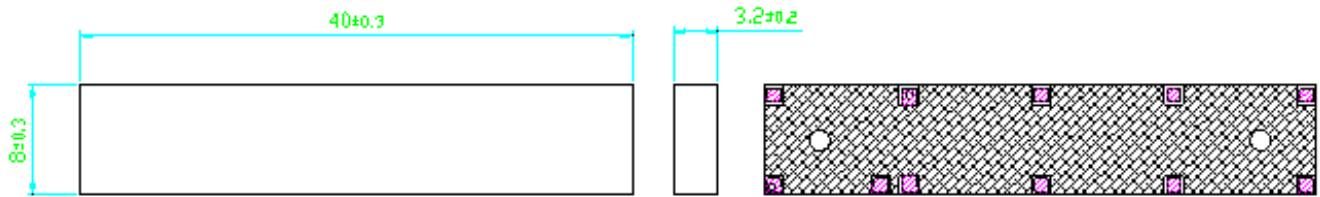

Unit: mm

Recommended Foot Print for Evaluation Board

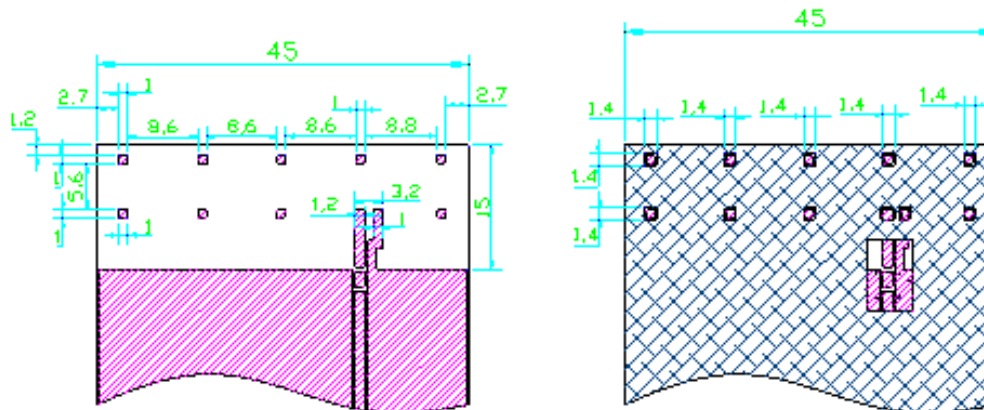

 Copper layer

Top layer

 Solder area

 Solder mask

Top layer

Tolerances unless otherwise specified ± 0.1 mm
t,w=Unique dimensioning according to your PCB.

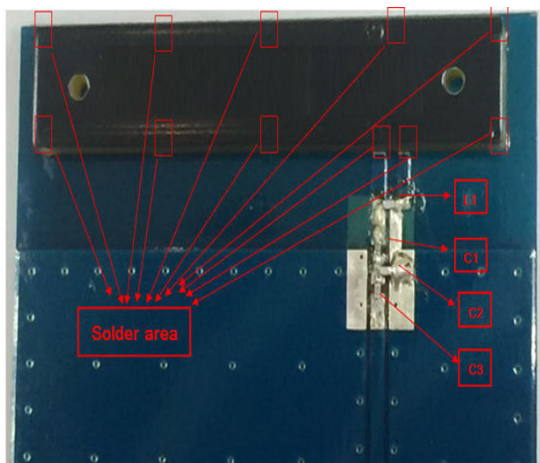

Circuit Symbol	Size	Description
L1	0402	6.8nH Inductor
C1	0402	6.8pF Capacitor
C2	0402	1.2pF Capacitor
C3	0402	6.8pF Capacitor

4G/LTE Ceramic Chip Antenna

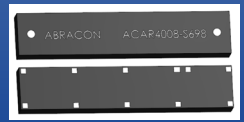

ACAR4008-S698



40.0 x 8.0 x 3.2 mm
RoHS/RoHS II Compliant
MSL = N/A

Environmental Conditions

Parameters	Description
Operating Temperature Range	-40°C to + 85°C
Relative Humidity	0 ~ 95% RH @ +40°C
Storage Temperature Range	-40°C to + 85°C

Packaging

1. Blister tape to IEC 286-3, polyester
2. 3,000pcs/reel
3. 370 x 360 x 275mm (3,000pcs/Carton)
4. GW – 7.2KG

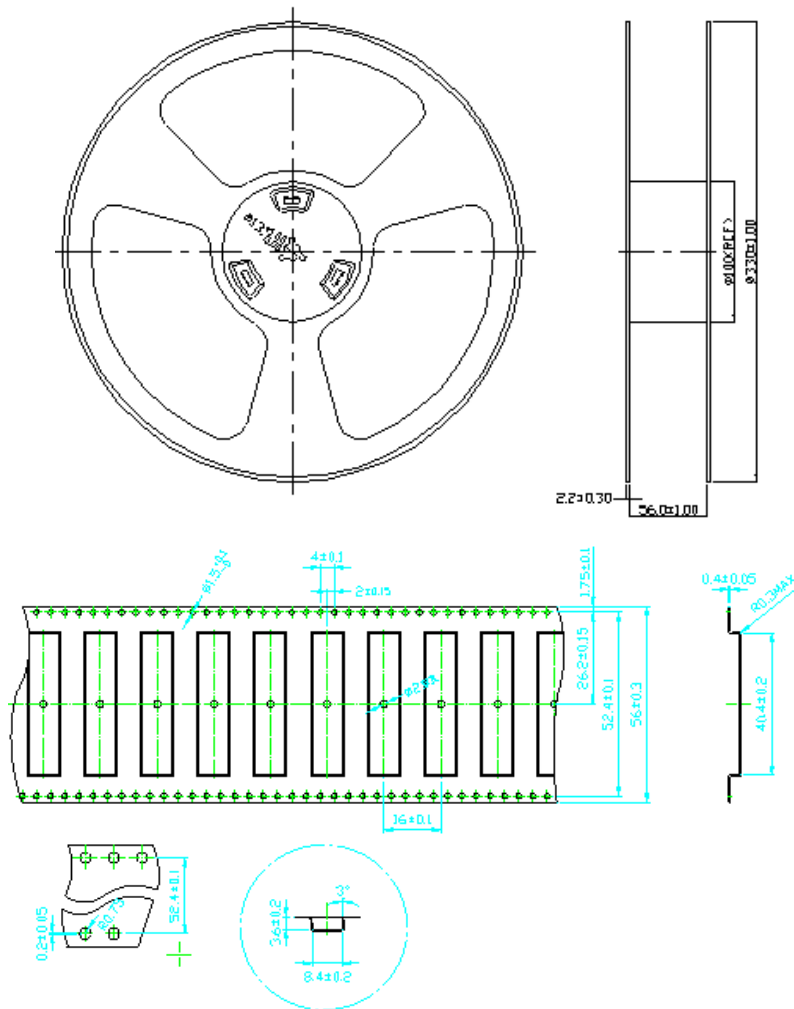

Unit: mm



5101 Hidden Creek Ln Spicewood TX 78669
Phone: 512-371-6159 | Fax: 512-351-8858
For terms and conditions of sales, please visit:
www.abracon.com

REVISED: 11.09.2018

ABRACON IS
ISO9001-2015
CERTIFIED

4G/LTE Ceramic Chip Antenna

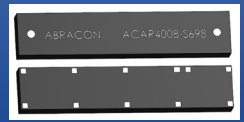

ACAR4008-S698



40.0 x 8.0 x 3.2 mm
RoHS/RoHS II Compliant
MSL = N/A

Transmission Line and Matching

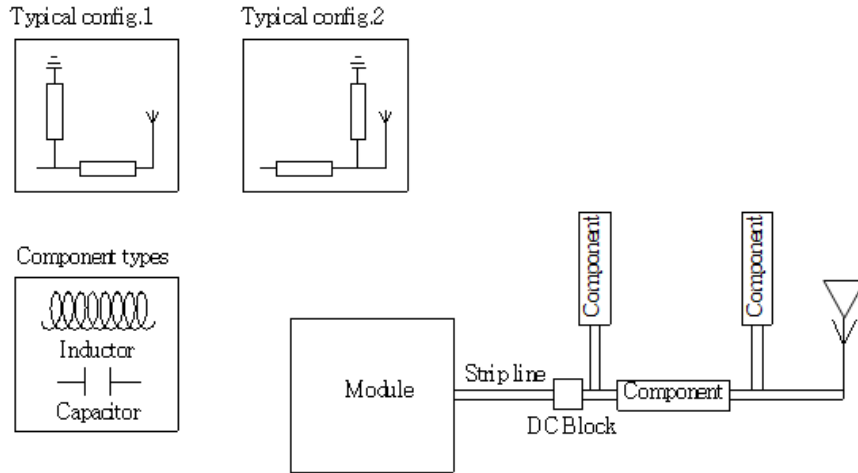

The matching network has to be individually designed using one, two, or three components.

Recommended Reflow Soldering Profile

Abrakon products can be assembled following Pb-free assembly. According to the Standard IPC/JEDEC J-STD-020C, the temperature profile suggested is as follow:

Phase	Profile features	Pb-Free Assembly (SnAgCu)
PREHEAT	-Temperature Min(Tsmin) -Temperature Max(Tsmax) -Time(ts) form (Tsmin to Tsmax)	150°C 200°C 60-120 seconds
RAMP-UP	Avg. Ramp-up Rate (Tsmax to TP)	3°C/second(max)
REFLOW	-Temperature(TL) -Total Time above TL (t L)	217°C 30-100 seconds
PEAK	-Temperature(TP) -Time(tp)	260°C 10-20 second
RAMP-DOWN	Rate	6°C/ second max.
Time from 25°C to Peak Temperature		8 minutes max.
Composition of solder paste		96.5Sn/3Ag/0.5Cu
Solder Paste Model		SHENMAO PF606-P26

4G/LTE Ceramic Chip Antenna

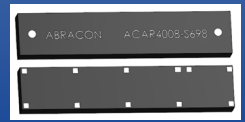

ACAR4008-S698



40.0 x 8.0 x 3.2 mm
RoHS/RoHS II Compliant
MSL = N/A

Recommended Reflow Soldering Profile

Note: All the temperature measure point is on top surface of the component, if temperature over recommend, it will make component surface peeling or damage.

The graphic shows temperature profile for component assembly process in reflow ovens

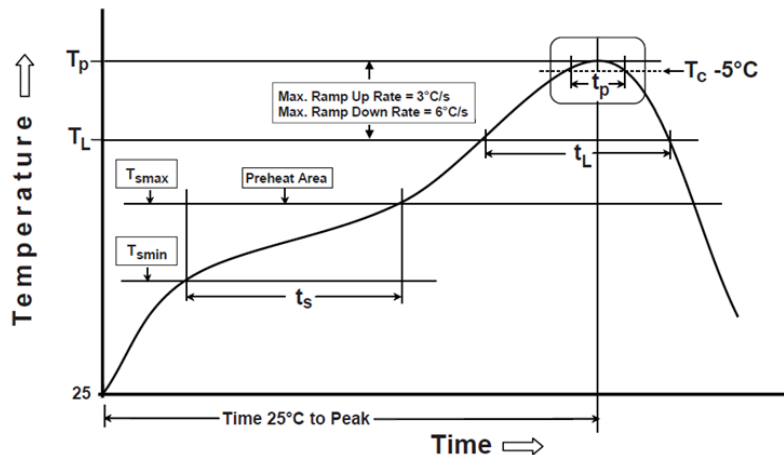

Soldering With Iron:

Soldering condition : Soldering iron temperature 270 ± 10 °C

Apply preheating at 120 °C for 2-3 minutes. Finish soldering for each terminal within 3 seconds, if soldering iron over temperature 270 ± 10 °C or 3 seconds, it will make component surface peeling or damage.

Soldering iron can not leakage of electricity.

ATTENTION: Abracon LLC's products are COTS – Commercial-Off-The-Shelf products; suitable for Commercial, Industrial and, where designated, Automotive Applications. Abracon's products are not specifically designed for Military, Aviation, Aerospace, Life-dependent Medical applications or any application requiring high reliability where component failure could result in loss of life and/or property. For applications requiring high reliability and/or presenting an extreme operating environment, written consent and authorization from Abracon LLC is required. Please contact Abracon LLC for more information.



5101 Hidden Creek Ln Spicewood TX 78669
Phone: 512-371-6159 | Fax: 512-351-8858
For terms and conditions of sales, please visit:
www.abracon.com

REVISED: 11.09.2018

ABRACON IS
ISO9001-2015
CERTIFIED