

MAX40056 Evaluation Kit

Evaluates: MAX40056F
MAX40056T
MAX40056U

General Description

The MAX40056 evaluation kit (EV kit) is a fully assembled electrical demonstration kit that provides a proven design to evaluate the MAX40056F/MAX40056T/MAX40056U high-precision, high-voltage, bidirectional current sense amplifier for PWM applications, such as servo motor control and solenoid drive. The MAX40056F/MAX40056T/MAX40056U are ideal for 48V, or less BLDC, induction motor applications (such as robotics), pick-and-place machines, 3D prints, or other servo motor control systems.

This EV kit demonstrates the MAX40056FAUA+ in an 8-pin μ MAX package, with Gain = 50V/V. For other available pin-compatible options (MAX40056TAUA+, Gain = 20V/V, MAX40056HAUA+, Gain = 10V/V), contact the factory.

Features

- Precision Real-Time Current-Monitoring with Fault Detection
- Internal Available 1.5V Reference
- -0.3V to +65V Input Common Mode Range
- -40°C to +125°C Temperature Range
- Evaluates 8- μ MAX MAX40056FAUA+ Device
- Proven PCB Layout
- Fully Assembled and Tested

Ordering Information appears at end of data sheet.

MAX40056 EV KIT PHOTO

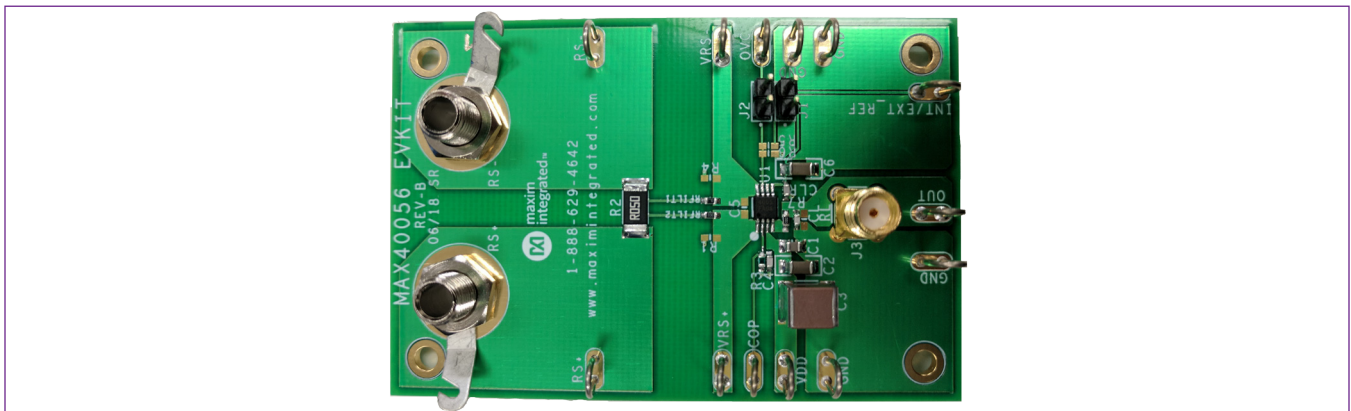

Agilent is a registered trademark and registered service mark of Agilent Technologies, Inc.

Quick Start

Required Equipment

- MAX40056 EV kit
- 0-60V, 3A DC Power Supply for VCM Input
- +3.6V, 100mA MAX40056F/MAX40056T/MAX40056U device DC power supply
- +3.6V DC power supply or a voltage calibrator for OVC/ CIP input
- Electronic load capable for sinking 3A (HP6060B)
- Three digital voltmeters (Agilent® 34401A 61/2 digital multimeter)

Procedure

The MAX40056 EV kit is fully assembled and tested. Follow the following steps to verify board operation:

Caution: Do not turn on the power supply or the electronic load until all the connections are complete.

- 1) Connect a +3.3V supply and ground to VDD connector.
- 2) Connect the positive terminal of the +0-60V DC power supply to the RS+ input and the negative terminal to the GND input.
- 3) Set the electronic load to sink 300mA.
- 4) Connect the positive terminal of the electronic load to the RS- input and the negative terminal of the electronic load to the nearest GND input connection on the board.
- 5) Connect the first voltmeter between the test points

VRS+ and VRS- to measure the differential input voltage across the inputs (V_{SENSE}).

- 6) Install jumper J2 and connect the positive terminal of the calibrator/DC power supply to OVC input. Set the calibrator/DC power supply voltage output to 500mV.
- 7) Connect the second voltmeter across OUT and GND test point to measure the MAX40056F/MAX40056T/MAX40056U output.
- 8) Connect the third voltmeter across COP and GND test point to measure over current fault status at COP output.
- 9) Turn on the power supplies and the calibrator and then the electronic load.
- 10) Enable the electronic load.
- 11) Verify that the first voltmeter displays 300mA x 50mΩ = +15mV and the second voltmeter displays 2.25V.
- 12) Verify that the COP output is high (+3.3V).
- 13) Now change the OVC input from 500mV to 1V on the calibrator output setting.
- 14) Verify that the COP output is low (~0V).
- 15) Turn off the electronic load and set the electronic load to source 300mA.
- 16) Turn on the electronic load and verify that the first voltmeter displays -15mV and the second voltmeter displays 750mV.
- 17) Verify that the COP output is low (~0V).
- 18) After the functions are verified, do not forget to turn off the electronic load, calibrator and the power supply.

Detailed Description of Hardware

The MAX40056 EV kit provides a proven design to evaluate MAX40056F/MAX40056T/MAX40056U high-precision, high-voltage bidirectional current sense amplifier for PWM application. The device offers precision accuracy specifications of input offset voltage (V_{OS}) less than 10μV (max) and gain error less than 0.2% (max).

The device has a proprietary input stage designed to reject high gradient PWM common mode voltage inputs and still accurately monitors the load current across its inputs.

Table 1. Jumper Functions (J1 – J2)

JUMPER LABEL	DEFAULT POSITION	FUNCTION
J1	Not Installed	OVC threshold input provided by REF output. Install R5 and R6 to create OVC threshold.
J2	Installed	OVC threshold input provided by external source

Theory of Operation

Bidirectional Operation

The MAX40056 EV kit evaluates the MAX40056F/MAX40056T/MAX40056U bidirectional current sense amplifier. The output is set to the V_{REF} voltage at no load. The V_{REF} voltage can either be from internal 1.5V reference voltage generated or an external reference supplied at V_{REF} input. That sets the bias voltage to V_{REF} (V) for a no-current condition. Current in the positive direction in reference to RS+ and RS- increases the output voltage from V_{REF} (V) and current in the negative direction decreases the output voltage from V_{REF} (V).

Hence, the output equation becomes:

$$V_{OUT} (V) = [(I_{LOAD}(A) \times R_{SENSE}(\Omega)) \times GAIN(V/V)] + V_{REF}(V)$$

External Reference

When choosing external reference at V_{REF} input, it is recommended to choose V_{REF} (V) = (1/2) x V_{DD} (V) and the V_{DD} (V) value must not exceed absolute maximum ratings.

Overcurrent Fault Protection

The MAX40056 device features an integrated window comparator to monitor overcurrent conditions. An overcurrent threshold voltage input is provided to the OVC input, which monitors for overcurrent detection in both the direction. When an overcurrent condition occurs, the output of the window comparator goes low indicating a fault detection.

The input range for OVC input is from 0.08V to MIN ($V_{REF} - 0.08, V_{DD} - 1.25$).

Threshold Input Options

When using an external voltage source to provide OVC threshold to the CIP input, install Jumper J2 and remove J1 if installed. Also make sure that the resistors R5 and R6 are also not populated.

When using the reference voltage to provide OVC threshold to the CIP input, remove J2 and install J1. Also install R5 and R6 resistors to create the desired value of OVC threshold value.

$$V_{OVC} (V) = [(V_{REF} \times R_6)/(R_5 + R_6)]$$

While choosing the value of R5 and R6, make sure the total resistance is large so that the REF output is not loaded. Recommended choice of $R_5 + R_6 = 500k\Omega$.

MAX40056 Evaluation Kit

Evaluates: MAX40056F
MAX40056T
MAX40056U

MAX40056 EV Kit Bill of Materials

ITEM	REF_DES	DN/DNP	QTY	MFG PART #	MANUFACTURER	VALUE	DESCRIPTION	COMMENTS
1	C1	-	1	C0805C103F1GAC	KEMET	0.01UF	CAPACITOR; SMT (0805); CERAMIC CHIP; 0.01UF; 100V; TOL=1%; TG=-55 DEGC TO +125 DEGC; TC=C0G	
2	C2, C6	-	2	GRM31CR72A105KA01L; C3216X7R2A105K160	MURATA;TDK	1UF	CAPACITOR; SMT; 1206; CERAMIC; 1uf; 100V; 10%; X7R; -55degC to + 125degC	
3	C3	-	1	CKG57NX7R2A106M500JH	TDK	10UF	CAPACITOR; SMT (2220); CERAMIC CHIP; 10UF; 100V; TOL=20%; MODEL=C SERIES; TG=-55 DEGC TO +125 DEGC; TC=X7R	
4	C4	-	1	C1608C0G1H100D080AA	TDK	10PF	CAPACITOR; SMT (0603); CERAMIC CHIP; 10PF; 50V; TOL=0.5PF; TG=-55 DEGC TO +125 DEGC; TC=C0G	
5	CL	-	1	C0603C200J5GAC; GRM1885C1H200JA01	KEMET;MURATA	20PF	CAPACITOR; SMT (0603); CERAMIC CHIP; 20PF; 50V; TOL=5%; MODEL=C; TG=-55 DEGC TO +125 DEGC; TC=C0G	
6	CLR	-	1	C1608C0G1H103J; CGA3E2C0G1H103J080AD; GRM1885C1H103JA01	TDK;TDK;MURATA	0.01UF	CAPACITOR; SMT (0603); CERAMIC CHIP; 0.01UF; 50V; TOL=5%; TG=-55 DEGC to +125 DEGC; TC=C0G	
7	COP, GND, GND1-GND3, INT/EXT_REF, OUT, OVC, RS+, RS-, VDD, VRS+, VRS-	-	13	9020 BUSS	WEICO WIRE	MAXIMPAD	EVK KIT PARTS; MAXIM PAD; WIRE; NATURAL; SOLID; WEICO WIRE; SOFT DRAWN BUS TYPE-S; 20AWG	
8	D1	-	1	SMBJ60A	DIODES INCORPORATED	60V	DIODE; TVS; SMB (DO-214AA); VRM=60V; IF=6.2A	
9	D2	-	1	CMSH5-60	CENTRAL SEMICONDUCTOR	CMSH5-60	DIODE; SCH; SILICON SCHOTTKY RECTIFIER;SMC; PIV=60V; IF=5A	
10	J1, J2	-	2	PCC02SAAN	SULLINS	PCC02SAAN	CONNECTOR; MALE; THROUGH HOLE; BREAKAWAY; STRAIGHT THROUGH; 2PINS; -65 DEGC TO +125 DEGC	
11	J3	-	1	5-1814832-1	TYCO	5-1814832-1	CONNECTOR; FEMALE; THROUGH HOLE; CONN SOCKET SMA STR DIE CAST PCB; STRAIGHT; 5PINS	
12	R2	-	1	CRA2512-FZ-R050ELF	BOURNS	0.05	RES; SMT (2512); 0.05; 1%; +/-50PPM/DEGC; 3W	
13	R3	-	1	PNM0603E5001B5T5	VISHAY DALE	5K	RESISTOR; 0603; 5K OHM; 0.1%; 25PPM; 0.15W; THIN FILM	
14	R7, RFILT1, RFILT2	-	3	RC1608J000CS; CR0603-J-000ELF;RC0603JR-070RL	SAMSUNG ELECTRONICS; BOURNS;YAGEO PH	0	RESISTOR; 0603; 0 OHM; 5%; JUMPER; 0.10W; THICK FILM	
15	RS+1, RS-1	-	2	6095	KEYSTONE	6095	CONNECTOR; FEMALE; PANELMOUNT; NON-INSULATED RECESSED HEAD BANANA JACK; STRAIGHT THROUGH; 1PIN	
16	U1	-	1	MAX40056FAUA+	MAXIM	MAX40056FAUA+	EVKIT PART - IC; MAX40056; BI-DIRECTIONAL CURRENT-SENSE AMPLIFIER; PACKAGE OUTLINE: 21-0036; PACKAGE CODE: U8+4	
17	PCB	-	1	MAX40056	MAXIM	PCB	PCB.MAX40056	-
18	RL	DNP	0	301-10K-RC	XICON	10K	RESISTOR, 0603, 10K OHM, 5%, 200PPM, 1/16W, THICK FILM	
19	C5	DNP	0	N/A	N/A	OPEN	PACKAGE OUTLINE 0603 NON-POLAR CAPACITOR	
20	R1, R4-R6	DNP	0	N/A	N/A	OPEN	PACKAGE OUTLINE 0603 RESISTOR	
TOTAL			34					

Ordering Information

PART	TYPE
MAX40056EVKIT#	EV Kit

#Denotes a RoHS-compliant device that may include lead(Pb) that is exempt under the RoHS requirements.

MAX40056 EV Kit Schematic

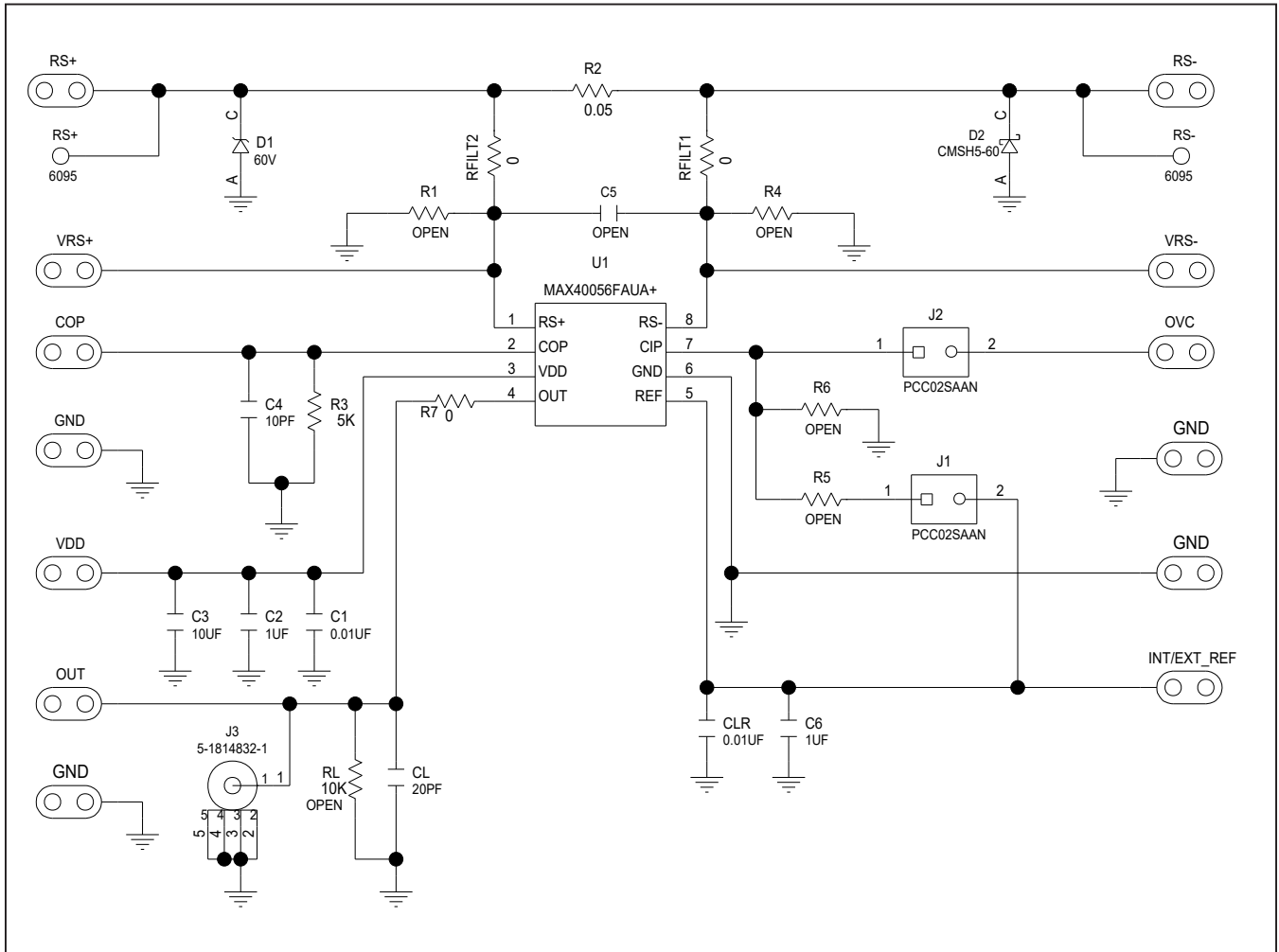

MAX40056 EV Kit PCB Layout Diagrams

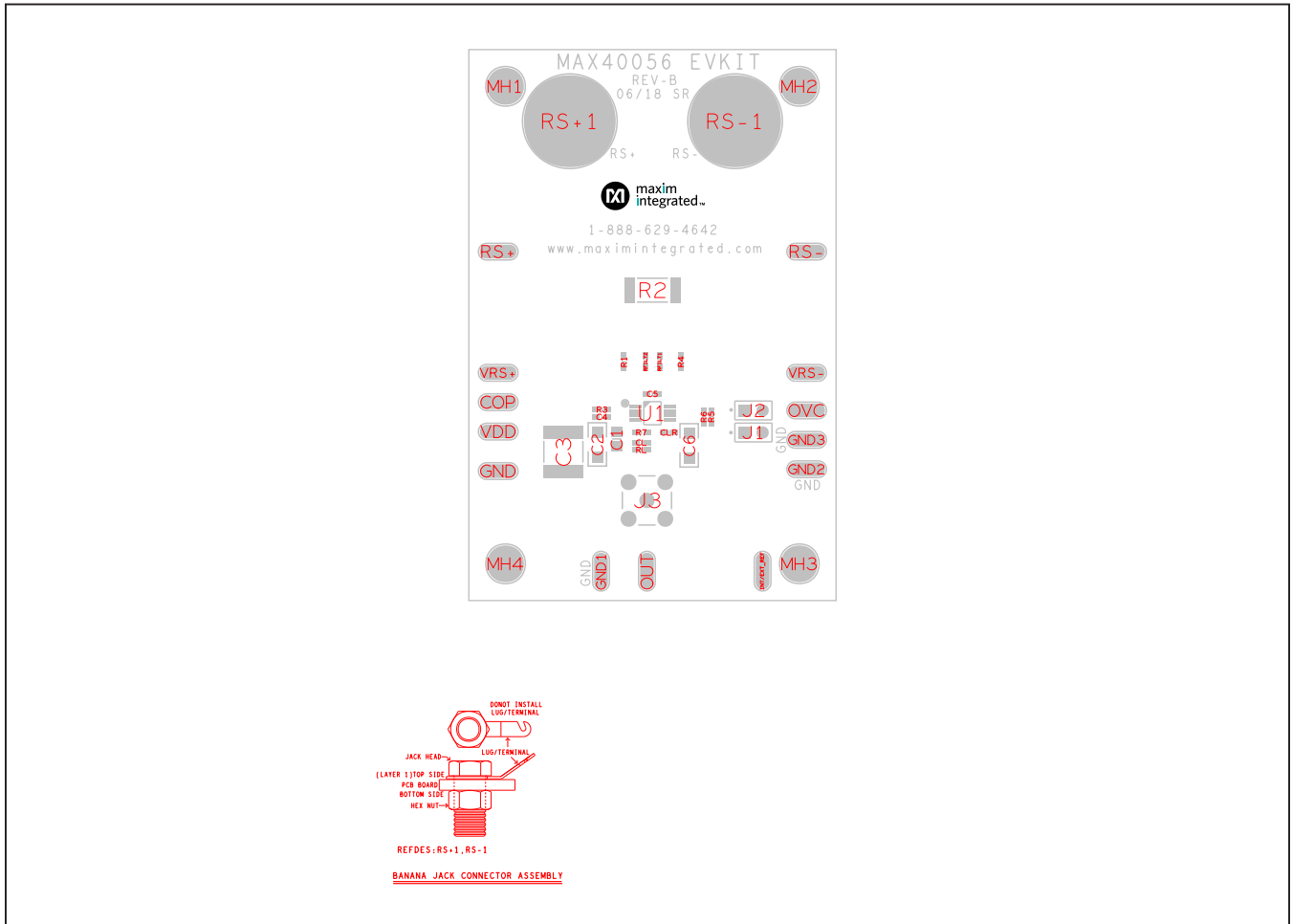

MAX40056 EV Kit PCB Layout Diagrams—Assembly Top

MAX40056 EV Kit PCB Layout Diagrams (continued)

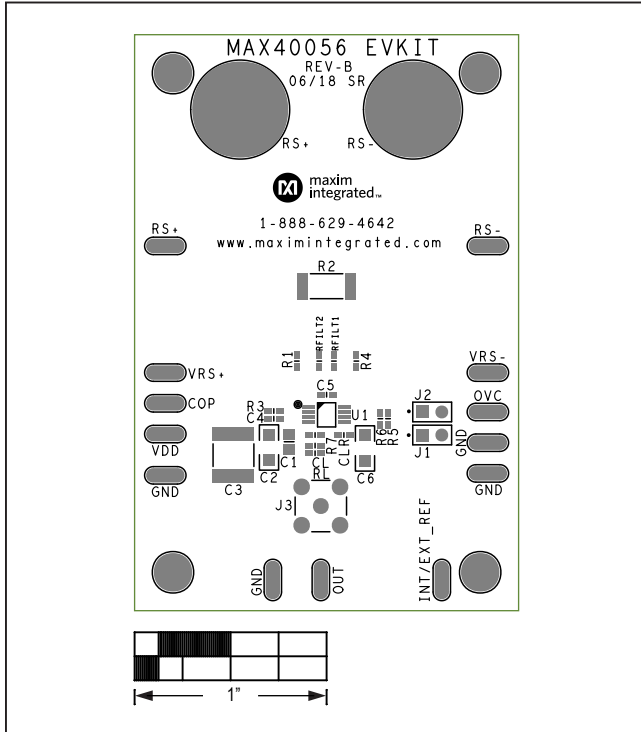

MAX40056 EV Kit PCB Layout Diagrams—Top Silkscreen

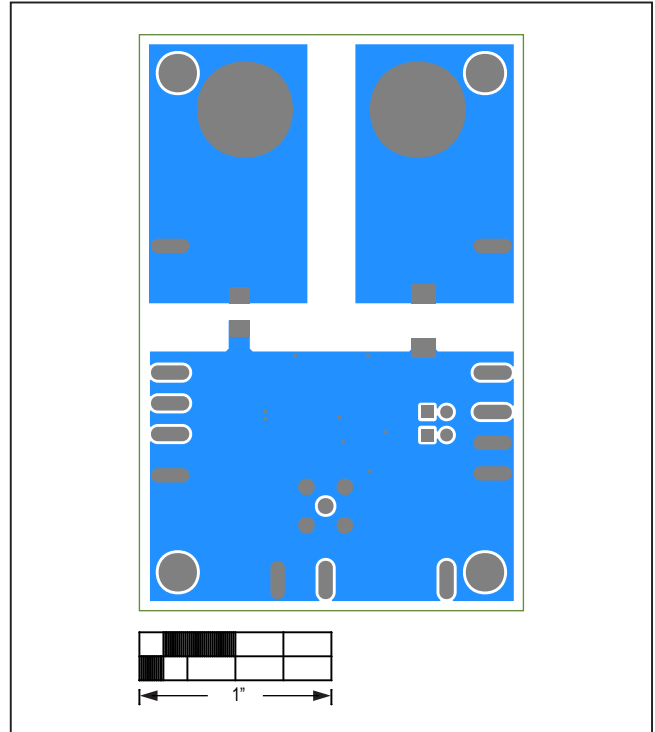

MAX40056 EV Kit PCB Layout Diagrams—Bottom

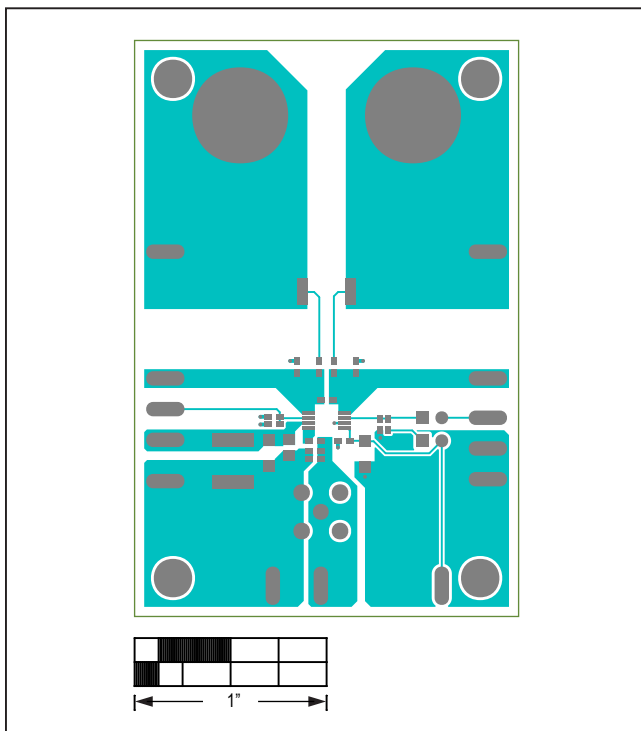

MAX40056 EV Kit PCB Layout Diagrams—Top

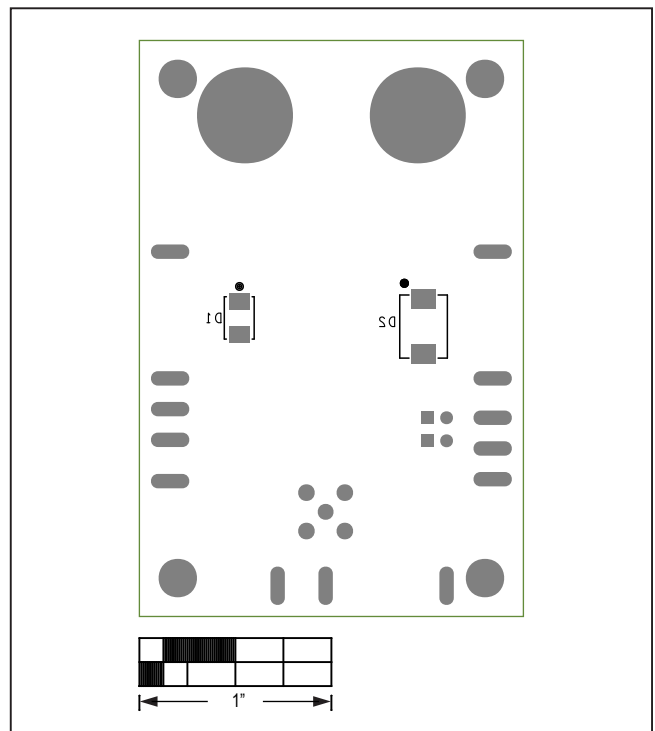

MAX40056 EV Kit PCB Layout Diagrams—Bottom Silkscreen

MAX40056 Evaluation Kit

Evaluates: MAX40056F
MAX40056T
MAX40056U

Revision History

REVISION NUMBER	REVISION DATE	DESCRIPTION	PAGES CHANGED
0	10/18	Initial release	—
1	12/18	Updated data sheet title, part number, and <i>Ordering Information</i>	1–7

For pricing, delivery, and ordering information, please visit Maxim Integrated's online storefront at <https://www.maximintegrated.com/en/storefront/storefront.html>.

Maxim Integrated cannot assume responsibility for use of any circuitry other than circuitry entirely embodied in a Maxim Integrated product. No circuit patent licenses are implied. Maxim Integrated reserves the right to change the circuitry and specifications without notice at any time.