

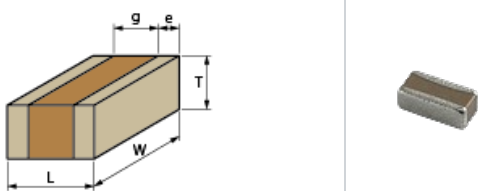

< List of part numbers with package codes >
 LLL215R71C223MA11L , LLL215R71C223MA11K

Shape



L size	1.25 ±0.1mm
W size	2.0 ±0.1mm
T size	0.5 +0/-0.15mm
External terminal width e	0.3±0.1mm
Distance between external terminals g	0.35mm min.
Size code in inch(mm)	0508 (1220M)

References

Packaging	Specifications	Minimum quantity
L	φ180mm Embossed taping	4000
K	φ330mm Embossed taping	10000

Mass (typ.)	
1 piece	7.0mg
φ180mm Reel	140g

Specifications

Capacitance	22000pF ±20%
Rated voltage	16Vdc
Temperature characteristics (complied standard)	X7R(EIA)
Capacitance change rate	±15.0%
Temperature range of temperature characteristics	-55 to 125°C
Operating temperature range	-55 to 125°C

Attention

- 1.This datasheet is downloaded from the website of Murata Manufacturing Co., Ltd. Therefore, it's specifications are subject to change or our products in it may be discontinued without advance notice. Please check with our sales representatives or product engineers before ordering.
- 2.This datasheet has only typical specifications because there is no space for detailed specifications. Therefore, please review our product specifications or consult the approval sheet for product specifications before ordering.