

GoldMax 300 Comm COG, Ceramic, 18 pF, 5%, 200 VDC, COG, GoldMax, Commercial Standard, Lead Spacing = 2.54mm

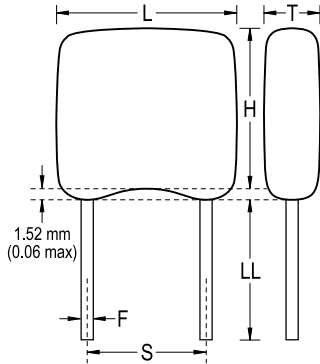

General Information	
Supplier:	KEMET
Series:	GoldMax 300 Comm COG
Style:	Radial
Description:	GoldMax, Commercial Standard
RoHS:	Yes
Termination:	Tin
Failure Rate:	N/A
Halogen Free:	Yes

Dimensions	
L	3.81mm MAX
H	3.14mm MAX
T	2.54mm MAX
S	2.54mm +/-0.78mm
LL	7mm MIN
F	0.51mm +0.1/-0.025mm

Specifications	
Capacitance:	18 pF
Capacitance Tolerance:	5%
Voltage DC:	200 VDC
Dielectric Withstanding Voltage:	500 V
Temperature Range:	-55/+125C
Temperature Coefficient:	COG
Dissipation Factor:	0.10% 25C
Aging Rate:	0% Loss/Decade Hour
Insulation Resistance:	100 GOhms

Packaging Specifications	
Packaging:	Bulk, Bag
Packaging Quantity:	500