

- Suitable for most general industrial purposes
- Manufactured from extruded bar or hot brass stampings
- Reliable and corrosion resistant

**1/8" – 1" BSP****Technical Data****Medium:**

Compressed air or any hydraulic fluids which are compatible with the materials indicated below.

**Operating Pressure:**

Dependent upon the type of tube being used, refer to Section 9.12 for details of tubing

**Operating Temperature:**

Dependent upon the type of tube being used, refer to Section 9.12 for details of tubing

**Thread Sizes**

1/8", 1/4", 3/8", 1/2", 3/4", 1" BSP

**Materials**

Brass to BS 2874:1986 (CZ121) for items manufactured from bar, brass to BS 2872: 1969 (CZ122) for items manufactured from stampings. Banjo bolts have a bright nickel plated finish.

**Ordering Information**

To order, quote appropriate product number from the tables on the following pages.



Plug

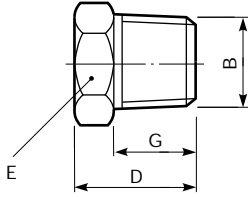

**Metric**  
Male taper BSP thread

Product number	B thread BSP	D	E A/F	G
36 0561 01	1/8"	14,5	10	9,5
36 0561 02	1/4"	16,5	14	11,1
36 0561 03	3/8"	19,0	17	12,7
36 0561 04	1/2"	22,5	22	15,9

Plug

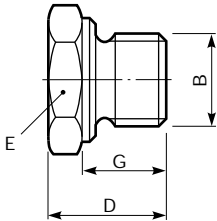

**Metric**  
Male parallel BSP thread

Product number	B thread BSP	D	E A/F	G
36 0523 01	1/8"	13	13	7,4
36 0523 02	1/4"	17	19	11,0
36 0523 03	3/8"	19	24	11,4
36 0523 04	1/2"	23	27	15,0
36 0523 06	3/4"	26	36	16,3
36 0523 08	1"	30	41	19,1

Sealing washer should be ordered separately, see page 9.8.001.09

**Inch**  
Male parallel BSP thread

Product number	B thread BSP	D	E A/F	G
34 0272 01	1/8"	0,56	0,45	0,31
34 0272 02	1/4"	0,56	0,60	0,34
34 0272 03	3/8"	0,63	0,82	0,37
34 0272 04	1/2"	0,75	0,92	0,44

Flanged Plug

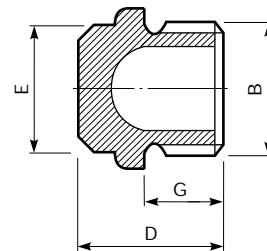

**Inch**  
Male parallel BSP thread

Product number	B thread BSP	D	E A/F	G
34 0276 01	1/8"	0,59	0,45	0,28
34 0276 02	1/4"	0,67	0,53	0,31
34 0276 03	3/8"	0,75	0,60	0,34
34 0276 04	1/2"	0,81	0,71	0,38
34 0276 05	5/8"	0,94	0,82	0,44
34 0276 06	3/4"	1,03	0,92	0,50
34 0276 08	1"	1,16	1,10	0,50

Sealing washer should be ordered separately, see page 9.8.001.09



### Tailpiece Adaptor

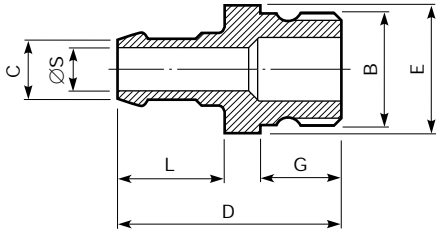

#### Metric

Male parallel BSP thread to hose

Product number	B thread BSP	C hose bore	D	E A/F	G	L	S
36 0321 08	1/8"	4,76	30,5	13	7,4	17,5	2,7
36 0321 09	1/8"	6,35	30,5	13	7,4	17,5	4,3
36 0321 16	1/4"	6,35	35,5	19	11,0	17,5	4,3
36 0321 18	1/4"	9,53	37,0	19	11,0	19,0	7,4
36 0321 19	1/4"	12,70	38,0	19	11,0	19,8	7,4
36 0321 26	3/8"	9,53	39,0	22	11,4	19,0	7,4
36 0321 27	3/8"	12,70	39,5	22	11,4	19,8	9,5
36 0321 36	1/2"	12,70	46,0	27	15,0	19,8	9,5

Sealing washer should be ordered separately, see page 9.8.001.09

### Tailpiece Adaptor

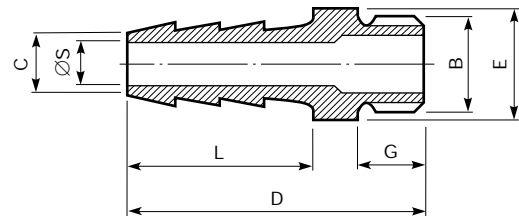

#### Inch

Male parallel BSP thread to hose

Product number	B thread BSP	C hose bore	D	E A/F	G	L	S
34 0321 16	1/4"	1/4"	1,63	0,60	0,37	1,00	0,19
34 0321 18	1/4"	3/8"	1,69	0,60	0,37	1,06	0,25
34 0321 19	1/4"	1/2"	1,69	0,71	0,37	1,06	0,31
34 0321 27	3/8"	1/2"	1,81	0,82	0,44	1,06	0,31
34 0321 36	1/2"	1/2"	1,94	0,92	0,50	1,06	0,31

Sealing washer should be ordered separately, see page 9.8.001.09

### Nipped Connector

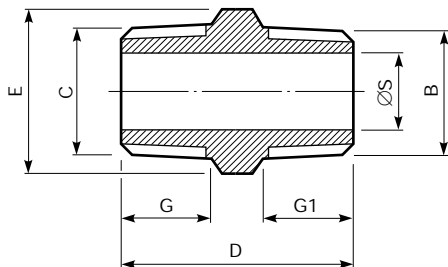

#### Metric

Male taper BSP thread

Product number	B thread BSP	C thread BSP	D	E A/F	G	G1	S
36 0633 01	1/8"	1/8"	24,0	10	9,5	9,5	4,7
36 0633 02	1/4"	1/4"	27,6	14	11,1	11,1	6,3
36 0633 03	3/8"	3/8"	31,7	17	12,7	12,7	9,6
36 0633 04	1/2"	1/2"	38,4	22	15,9	15,9	12,7
36 0633 05	3/4"	3/4"	45,1	27	19,1	19,1	19,0
36 0633 06	1"	1"	53,2	36	22,2	22,2	25,5
36 0633 36	3/4"	1/2"	42,0	27	15,9	19,1	12,7



### Straight Connector

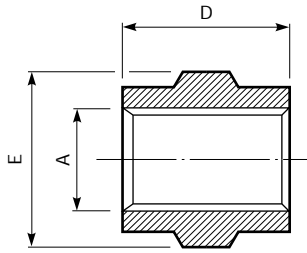

**Metric**  
Female BSP thread

Product number	A thread BSP	D	E A/F
36 0736 01	1/8"	15	14
36 0736 02	1/4"	22	19
36 0736 04	1/2"	30	27

### Reducing Connector

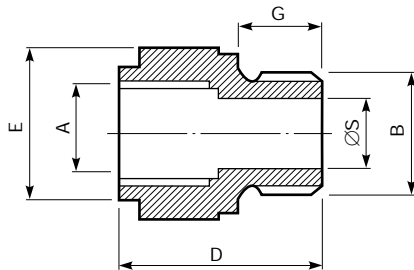

**Metric**  
Male parallel BSP thread to female parallel BSP thread

Product number	A thread BSP	B thread BSP	D	E A/F	G	S
36 0544 11	1/8"	1/4"	23,7	19	11,0	6,4
36 0544 20	1/4"	3/8"	28,2	24	11,4	9,5
36 0544 21	1/4"	1/2"	28,0	27	15,0	9,5
36 0544 28	3/8"	1/2"	34,0	27	15,0	12,7
36 0544 36	1/2"	3/4"	37,0	36	16,3	13,6
36 0544 47	3/4"	1"	41,0	41	19,1	19,0

Sealing washer should be ordered separately, see page 9.8.001.09

**Inch**  
Male parallel BSP thread to female parallel BSP thread

Product number	A thread BSP	B thread BSP	D	E A/F	G	S
34 0349 11	1/8"	1/4"	0,94	0,71	0,44	0,25
34 0349 12	1/8"	3/8"	0,94	0,92	0,44	0,25
34 0349 20	1/4"	3/8"	1,00	0,92	0,44	0,37
34 0349 21	1/4"	1/2"	1,13	1,10	0,56	0,37
34 0349 28	3/8"	1/2"	1,19	1,10	0,56	0,50

Sealing washer should be ordered separately, see page 9.8.001.09

### Straight Adaptor

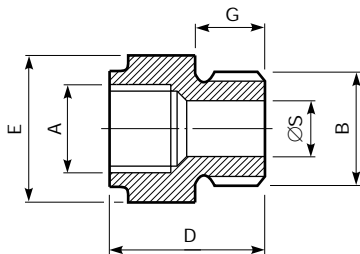

**Metric**  
Female parallel BSP to male parallel BSP thread

Product number	A thread BSP	B thread BSP	D	E A/F	G	S
36 0598 11	1/4"	1/8"	26	17	7,4	5,0
36 0598 20	3/8"	1/4"	30	22	10,0	6,5
36 0598 28	1/2"	3/8"	36	27	11,4	9,5
36 0598 36	3/4"	1/2"	42	36	15,0	12,5

Sealing washer should be ordered separately, see page 9.8.001.09



## Elbow Banjo Assembly

### Non Regulating Bolt

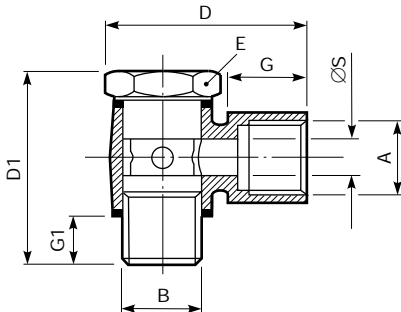

Female parallel BSP thread to male parallel BSP thread

Product number	A thread BSP	B thread BSP	D	D1	E A/F	G	G1	S
34 0388 01	1/8"	1/8"	29	29	14	9,0	6,5	6,0
34 0388 02	1/4"	1/4"	38	33	17	13,5	7,5	7,6
34 0388 03	3/8"	3/8"	44	41	22	13,9	10,0	9,6
34 0388 04	1/2"	1/2"	56	49	27	18,5	14,0	9,6

## Elbow Banjo Assembly

### Regulating Bolt

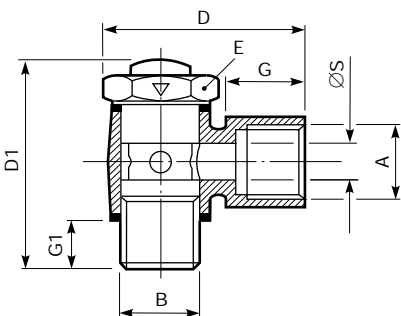

Female parallel BSP thread to male parallel BSP thread

Product number	A thread BSP	B thread BSP	D	D1	E A/F	G	G1	S
34 0389 01	1/8"	1/8"	29	34	14	9,0	7,5	6,0
34 0389 02	1/4"	1/4"	38	37	17	13,5	8,0	7,6
34 0389 03	3/8"	3/8"	44	52	22	13,9	12,0	9,6
34 0389 04	1/2"	1/2"	56	58	27	18,5	14,5	9,6

Arrow on bolt hexagon indicates free flow direction.



## Elbow Banjo Body

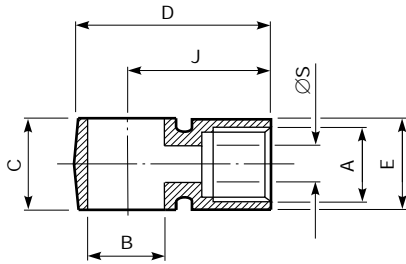

Female parallel BSP thread

Product number	A thread BSP	B for BSP bolt	C	D	E A/F	J	S
34 0387 01	1/8"	1/8"	14,0	28,0	13,0	9,8	6,0
34 0387 02	1/4"	1/4"	16,0	37,0	16,0	13,4	7,6
34 0387 03	3/8"	3/8"	20,5	42,0	20,5	16,8	9,6
34 0387 04	1/2"	1/2"	25,0	53,5	24,7	21,1	9,6

## Banjo Bolt – Non Regulating

Single Stacking

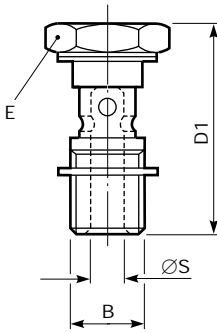

Double Stacking

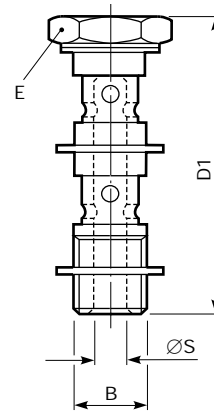

Male parallel BSP thread

Product number	B thread BSP	D1	E A/F	S
36 0451 01K	1/8"	29	14	4,5
36 0451 02K	1/4"	33	17	5,5
36 0451 03K	3/8"	41	22	9,2
36 0451 04K	1/2"	49	27	10,5

Male parallel BSP thread

Product number	B thread BSP	D1	E A/F	S
36 0452 01K	1/8"	44	14	4,5
36 0452 02K	1/4"	50	17	5,5
36 0452 03K	3/8"	62,5	22	9,2
36 0452 04K	1/2"	74	27	10,5

All banjo bolts supplied complete with sealing washers



## Banjo Bolt – Regulating

### Single Stacking

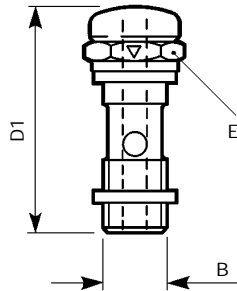

### Regulating Out

Male parallel BSP thread



Product number	B thread BSP	D1	E A/F
36 0461 01K	1/8"	34,0	14
36 0461 02K	1/4"	36,5	17
36 0461 03K	3/8"	51,5	22
36 0461 04K	1/2"	58,0	27

### Regulating In

Male parallel BSP thread

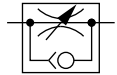

Product number	B thread BSP	D1	E A/F
36 0460 01K	1/8"	34,0	14
36 0460 02K	1/4"	36,5	17
36 0460 03K	3/8"	51,5	22
36 0460 04K	1/2"	58,0	27

### Bi-directional Flow

Male parallel BSP thread

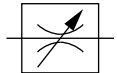

Product number	B thread BSP	D1	E A/F
36 0459 01K	1/8"	34,0	14
36 0459 02K	1/4"	36,5	17
36 0459 03K	3/8"	51,5	22
36 0459 04K	1/2"	58,0	27

All banjo bolts supplied complete with sealing washers. Arrow on bolt hexagon indicates free-flow direction.

## Sealing Washer – for use with banjo fitting

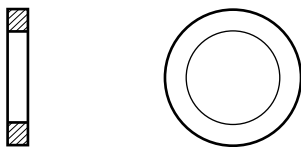

Product number	For BSP thread
48 0213 01	1/8"
48 0213 02	1/4"
48 0213 03	3/8"
48 0213 04	1/2"

Material: Copper



### Single-Sided Manifold

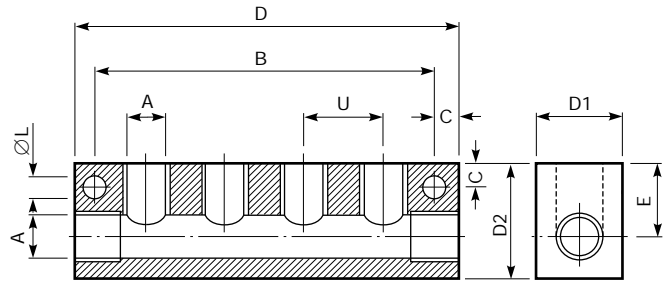

**Inch**  
Female parallel BSP thread

Product number	No. of outlets	A thread BSP	B	C	D	D1	D2	E	L	U
34 0504 01	4	1/8"	71	5	81	16,0	25,0	15	5,5	17
34 0504 02	4	1/4"	99	5	109	23,0	31,0	20	5,5	23
34 0504 03	4	3/8"	115	6	127	25,4	34,9	23	6,5	27
34 0506 01	6	1/8"	105	5	115	16,0	25,0	15	5,5	17
34 0506 02	6	1/4"	145	5	155	23,0	31,0	20	5,5	23
34 0506 03	6	3/8"	169	6	181	25,4	34,9	23	6,5	27

### Locknut

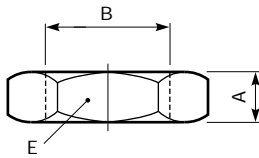

### Metric

Product number	B thread BSP	D	E A/F
36 0546 01	1/8"	4,8	13
36 0546 02	1/4"	6,4	17
36 0546 03	3/8"	6,4	22
36 0546 04	1/2"	6,4	27
36 0546 06	3/4"	7,1	32
36 0546 07	7/8"	7,9	36
36 0546 08	1"	8,7	41
36 0546 09	1 1/4"	8,7	50
36 0546 10	1 1/2"	9,5	55

### Inch

Product number	B thread BSP	D	E A/F
34 0223 01	1/8"	0,19	0,53
34 0223 02	1/4"	0,25	0,71
34 0223 03	3/8"	0,25	0,82
34 0223 04	1/2"	0,25	1,01
34 0223 06	3/4"	0,28	1,30
34 0223 07	7/8"	0,31	1,48
34 0223 08	1"	0,34	1,67





### Folded Copper Sealing Washer

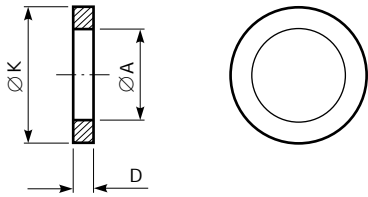

#### Metric and Inch

Product number	For BSP thread	A	D	K
48 0213 01	1/8"	9,8	1,5	13,5
48 0213 02	1/4"	13,2	1,5	17,7
48 0213 03	3/8"	16,7	1,5	21,0
48 0213 04	1/2"	21,0	1,5	26,4
48 0213 05	5/8"	23,0	1,8	28,6
48 0213 06	3/4"	26,5	1,8	32,4
48 0213 07	7/8"	30,2	1,8	36,2
48 0213 08	1"	33,3	1,8	38,9
48 0213 09	1 1/4"	42,0	2,2	49,9

### Bonded Sealing Washer

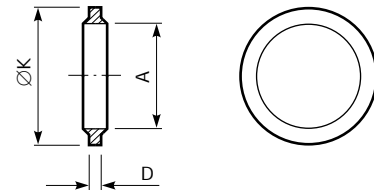

#### Inch

Product number	A for BSP thread	D	K
48 0215 01	1/8"	2,1	16,0
48 0215 02	1/4"	2,1	20,6
48 0215 03	3/8"	2,1	23,8
48 0215 04	1/2"	2,5	28,6
48 0215 05	5/8"	2,5	31,7
48 0215 06	3/4"	2,5	34,9

### 'O' Ring Seal

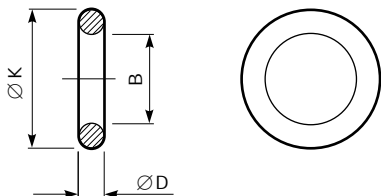

#### Metric

Product number	B for BSP thread	D	K
48 0261 06	1/8"	1,6	11,3
48 0261 09	1/4"	1,6	14,3
48 0261 13	3/8"	1,6	18,3
48 0249 16	1/2"	2,4	23,4
48 0249 19	3/4"	2,4	29,4
48 0250 08	1"	3,0	35,5



### Warning

These products are intended for use in industrial compressed air systems only. Do not use these products where *pressures* and *temperatures* can exceed those listed under '**Technical Data**'.

Before using these products with fluids other than those specified, for non-industrial applications, life-support systems, or other applications not within published specifications, consult NORGREN MARTONAIR.

Through misuse, age, or malfunction, components used in fluid power systems can fail in various modes. The system designer is warned to consider the failure modes of all component parts used in fluid power systems and to provide adequate safeguards to prevent personal injury or damage to equipment in the event of such failure.

**System designers must provide a warning to end users in the system instructional manual if protection against a failure mode cannot be adequately provided.**

System designers and end users are cautioned to review specific warnings found in instruction sheets packed and shipped with these products.