

A765, Polymer Aluminum, 105C LowZ, 10 uF, 20%, 35 VDC, -55/+105C

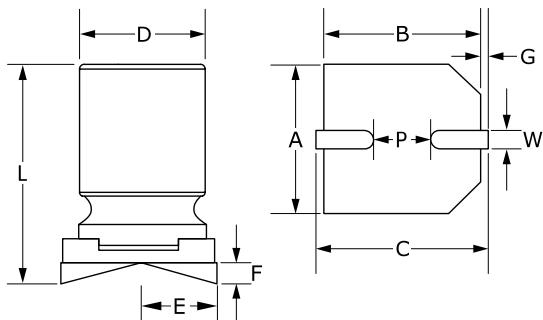

Dimensions	
D	6.3mm +/-0.5mm
L	5.7mm +/-0.3mm
W	0.5 - 0.8mm
F	0.2mm MAX
A	6.6mm +/-0.2mm
B	6.6mm +/-0.2mm
C	7.3mm +/-0.2mm
E	2.6mm +/-0.2mm
G	0.35mm +/-0.2mm
P	2.1mm +/-0.2mm

Packaging Specifications	
Packaging:	T&R, 380mm
Packaging Quantity:	1000

General Information	
Supplier:	KEMET
Series:	A765
Dielectric:	Polymer Aluminum
Style:	SMD Can
Description:	Surface Mount, Polymer Aluminum
RoHS:	Yes
Lead:	V-Chip

Specifications	
Capacitance:	10 uF
Capacitance Tolerance:	20%
Voltage DC:	35 VDC, 40.2 VDC (Surge)
Temperature Range:	-55/+105C
Rated Temperature:	105C
Life:	2000 Hrs
Resistance:	85 mOhms (100kHz 20C)
Ripple Current:	800 mAmps (100kHz 105C)
Leakage Current:	300 uA (2min 20C)
Impedance Ratio at -25C:	1.25
Impedance Ratio at -55C:	1.25
High Temperature Solder:	No