



Main

Range of product	OsiSense XC
Series name	Miniature format
Product or component type	Wireless limit switch
Device short name	XCMW
Sensor design	Miniature
Body type	Fixed
Head type	Plunger head

Complementary

Body material	Plastic
Head material	Metal
Lever material	Metal
Fixing mode	By 2 screws
Type of operator	Metal spring return roller plunger
Switch actuation	By 30° cam
Type of approach	2 directions lateral approach
Communication network type	ZigBee green power 2.4 GHz conforming to IEEE 802.15.4
Electrical composition code	PW1
Emission power	3 mW
Response time	<= 2 ms
Maximum sensing distance	100 m in free field 25 m in industrial environment 300 m with external antenna
Contact operation	Snap action
Number of steps	1
Maximum force for tripping	50 N
Maximum actuation speed	0.5 m/s
Operating rate	<= 60 cyc/mn
Mechanical durability	400000 cycles
Switching operation per hour	3600
Width	30 mm
Height	84 mm

Disclaimer: This documentation is not intended as a substitute for and is not to be used for determining suitability or reliability of these products for specific user applications

Depth	16 mm
Product weight	0.046 kg

Environment

Electromagnetic compatibility	Immunity for industrial environments Radiated emission Susceptibility to electromagnetic fields : 3 V/m, 80...2700 MHz, distance = 20 m Susceptibility to electromagnetic fields : 10 V/m, 80...2000 MHz Electrostatic discharge immunity test : 6 kV, on contact (on metal parts) Electrostatic discharge immunity test : 8 kV, in free air (in insulating parts)
Shock resistance	50 gn (duration = 11 ms) conforming to IEC 60068-2-27
Vibration resistance	+/- 10 mm (vibration frequency: 2...11 Hz) conforming to IEC 60068-2-6 25 gn (vibration frequency: 10...500 Hz) conforming to IEC 60068-2-6
IP degree of protection	IP65 conforming to IEC 60529
IK degree of protection	IK04 conforming to EN 50102
Ambient air temperature for operation	-25...55 °C
Ambient air temperature for storage	-40...70 °C
Directives	1999/5/EC - R&TTE directive 2004/108/EC - electromagnetic compatibility
Standards	EN/IEC 60947-1 EN/IEC 60947-5-1
Radio agreement	IC RSS FCC RCM

Dimensions

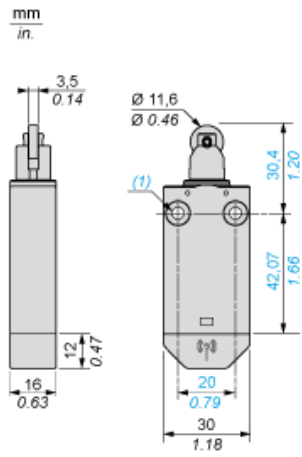

(1) : 2 fixing holes \varnothing 4.2 mm (\varnothing 0.17 in.)

Screw Mounting

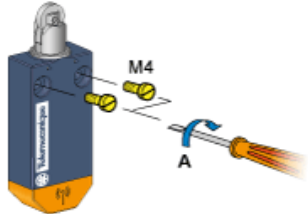

A = 1 Nm ± 0.1
A = 8.85 lb.in. ± 0.89

Unobstructed Mounting

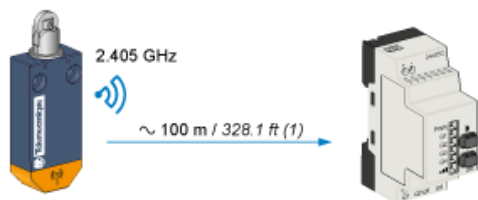

(1) : Typical values that may be modified by the application environment.

Mounting in a Metal Cabinet

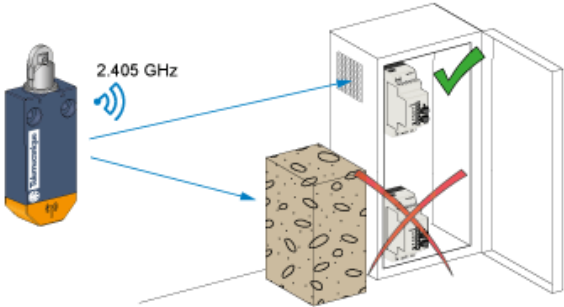

Signal Attenuation According to the Material

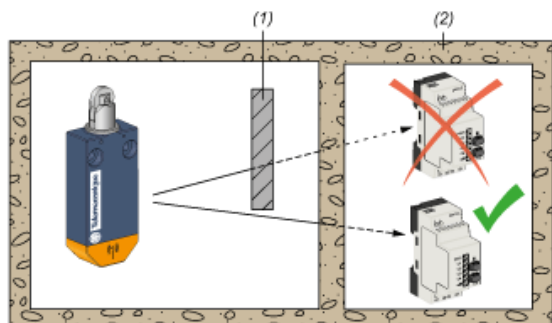

- (1) : Metal structure
- (2) : Wall
- (3) : Values for indication purposes only

NOTE: Actual values depend on the thickness and nature of the material.

Material	Signal attenuation (%)
Glass window	10...20% (3)
Plaster wall	20...45% (3)
Brick wall	60% (3)
Concrete wall	70...80% (3)
Metal structure	50...100% (3)

Mounting Tips for Antenna

Optimized Installation

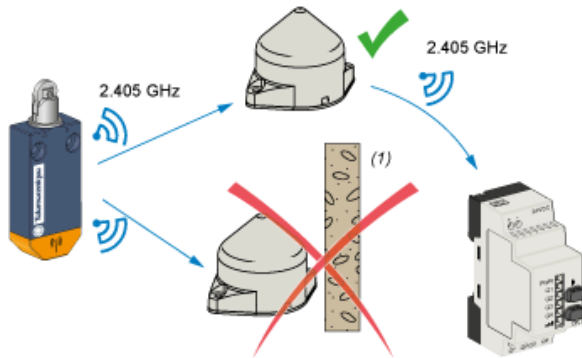

(1): Obstacle

The Relay Antenna is used to Bypass an Obstacle and/or Increase the Range

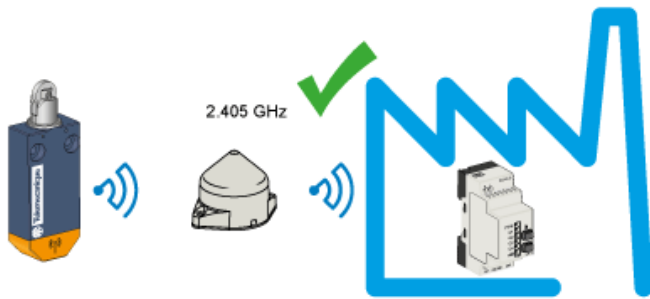

Characteristics of Actuation

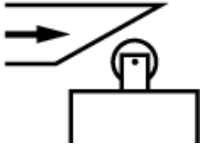

Technical Description

Functionnal Diagram, Travel Distance



- (1) : Reset
- (2) : Set