

Data sheet | Item number: 2091-1108

1-conductor female plug; Gripping plate; 1.5 mm²; Pin spacing 3.5 mm; 8-pole

www.wago.com/2091-1108

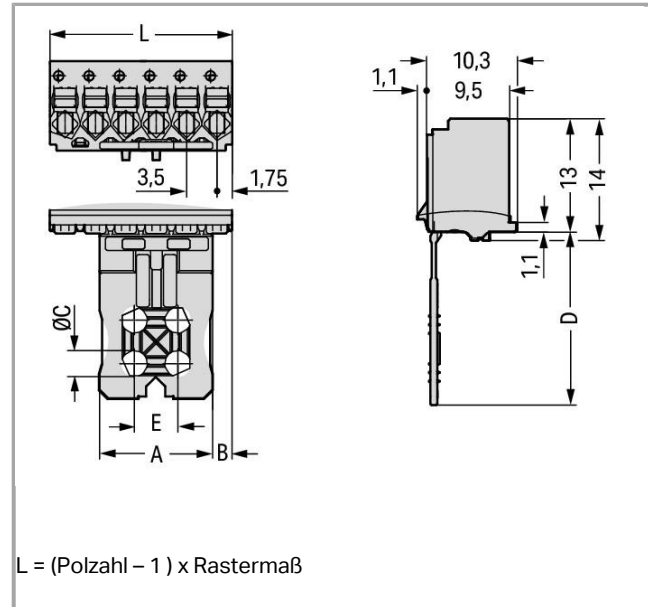

RoHS Compliant

BOMcheck.net

Color:

Item description

- Universal connection for all conductor types
- Simple, push-in termination of solid and ferruled conductors
- Easy-to-use design does not require specialty tools
- Ability to wire while mated or unmated
- Test port parallel to conductor entry – touch contact



- Integrated locking latches prevent accidental disconnection

Safety information 1:

The **picoMAX® pluggable connection system** is designed without breaking capacity for compliance with DIN EN 61984. When used as intended, MCS Connectors shall not be connected/disconnected when live or under load. The circuit design should ensure header pins, which can be touched, are not live when unmated.

Data

Electrical data

Ratings per IEC/EN 60664-1

Rated voltage (III / 3)	160 V
Rated impulse voltage (III / 3)	2.5 kV
Rated voltage (III / 2)	160 V
Rated impulse voltage (III / 2)	2.5 kV
Rated voltage (II / 2)	320 V
Rated impulse voltage (II / 2)	2.5 kV
Rated current	10 A

Approvals per UL 1059

Rated voltage UL (Use Group B)	300 V
Rated current UL (Use Group B)	10 A
Rated voltage UL (Use Group D)	300 V

Connection data

Connection technology	Push-in CAGE CLAMP®
Actuation type	Push-button
Solid conductor	0.2 ... 1.5 mm ² / 24 ... 14 AWG
Fine-stranded conductor	0.2 ... 1.5 mm ² / 24 ... 14 AWG
Fine-stranded conductor with ferrule with plastic collar	0.25 ... 0.75 mm ²
Fine-stranded conductor with ferrule without plastic collar	0.25 ... 1.5 mm ²
Strip length	8 ... 9 mm / 0.31 ... 0.35 inch
No. of poles	8
Total number of connection points	8
Total number of potentials	8
Number of connection types	1
Number of levels	1
Leiterquerschnitte eindrätig	0.2 mm ²



Geometrical Data

Pin spacing	3.5 mm / 0.138 inch
Width	28 mm / 1.102 inch
Height	33 mm / 1.299 inch
Depth	11.4 mm / 0.449 inch

Mechanical data

Design	With gripping plate
--------	---------------------

Plug connection

Contact type (pluggable connector)	Female connector/socket
Connector connection type	for conductors
Mismating protection	No

Material Data

Color	light gray
Material group	I
Insulating material	Polyphthalamide (PPA GF)
Flammability class per UL94	V0
Clamping spring material	Chrome nickel spring steel (CrNi)
Contact material	Electrolytic copper (E_{Cu})
Contact plating	tin-plated
Fire load	0.094 MJ
Weight	3.8 g

Environmental Requirements

Limit temperature range	-60 ... +100 °C
-------------------------	-----------------



Commercial data

Product Group	26 (picoMAX)
Country of origin	DE
GTIN	4050821160724
Customs Tariff No.	85366990990



Approvals / Certificates

Country specific Approvals

Logo	Approval	Additional Approval Text	Certificate name



	CB DEKRA Certification B.V.	IEC 61984	NL-49736
	CSA DEKRA Certification B.V.	C22.2	2362521
	KEMA/KEUR DEKRA Certification B.V.	EN 61984	71- 102260

UL-Approvals

Logo	Approval	Additional Approval Text	Certificate name
	UR Underwriters Laboratories Inc.	UL 1059	E45172
	UR Underwriters Laboratories Inc.	UL 1977	20170428- E45171
	UR Underwriters Laboratories Inc.	UL 1059	E45172

Compatible products

Coding

	Item no.: 2091-1610 Coding key carrier; suitable for 3.5 mm pin spacing	www.wago.com/2091-1610
check		
	Item no.: 735-500 Test pin; 1 mm Ø; with solder connection for test wire	www.wago.com/735-500
tools		
	Item no.: 210-719 Operating tool with partially insulated shaft; Type 1, blade (2.5 x 0.4) mm	www.wago.com/210-719

Downloads

Documentation

Additional Information



Technical explanations

03-Apr-2019

pdf
3.6 MB

Download

CAD/CAE - Smart Data

CAD data

3D Download 2091-1108

URL

Download

Product family

picoMAX

[Learn more about the product family.](#)

[Show all products from the family](#)

Subject to changes.

WAGO Kontakttechnik GmbH & Co. KG

Hansastr. 27

32423 Minden

Phone: +49571 887-0 | Fax: +49571 887-169

Email: info.de@wago.com | Web: www.wago.com

Do you have any questions about our products?

We are always happy to take your call at {0}.