

DC Control System

MD & AD Series



CERTIFIED

CERTIFIED & DOCUMENTED fastening results. Supplied with FREE certification.



LEANER

Operate a LEANER production environment with flexible, configurable tool set up.



COMPLIANCE

Make fastening COMPLIANCE and documentation easy.



mountz[®]
the torque tool specialists[®]

Introduction

The MD or AD-Series is a durable torque and automation control system engineered for precise, accurate and repeatable torque control. The high performance torque fastening system by Mountz allows manufacturers to optimize the assembly area, reduce labor costs and increase productivity.

The DC control tool delivers cost savings and quality benefits through useful features such as digitally adjustable torque setting, variable torque and speed control, multiple I/O options for integration with PLC and other line control techniques. A Windows-based software package that can customize each fastening application is included with the product. The torque control system features error-proofing capabilities and screw counting. Multiple fastening strategies can be implemented for sensitive and/or difficult assembly joints. The system increases productivity as one tool can be programmed to do the job of multiple conventional tools; saving time, maintenance cost, space and training.



Easy guidance to the optimized tightening process with built-in customizing simulation feature.

15 tightening presets, 15 parameters within each preset. This strategy can be extended up to 99 presets with optional TPM touch screen.

Each Preset Program has the following customized parameters

Tightening Mode	Torque control + angle monitoring (TC/AM) Angle control + torque monitoring (AC/TM)
Torque	Target torque, min/max torque, snug torque, seating torque, torque compensation
Angle	Target angle, min/max angle, free speed angle
Speed	Target speed, Free speed, Ramp up speed
Time	Soft start time, torque rising time, torque holding time

Key Benefits

Productivity	Increase productivity with one tool instead of 2 - 8 tools. Provides consistent repeatable process control and eliminates potential variations.
Flexibility	Easy integration into production line. Rapid reconfiguration for new production projects.
ROI	Optimum asset utilization. Tooling expense delivers favorable return of investment.
Quality	Traceability and error-proofing. Real time monitoring. Swiss DC servo motor provides precise, accurate and repeatable torque control.
I/O Interface	Digital I/O signals for communication with external devices such as PLC.
Controller	Up to 15 process sequences with 10 program steps.
Memory	Collect and save all fastening data on SD memory card.
Torque Analysis	Fastening torque data analysis (Standard Deviation, Mean, Average, CP, CPK) with TPM (Torque Process Monitoring) Touch Screen accessory option.

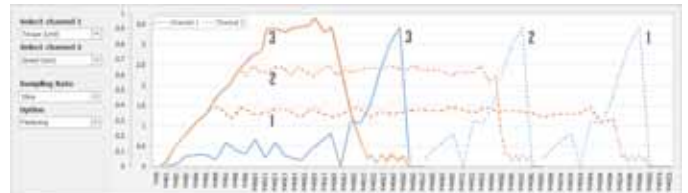

Auto Customizing

Auto customizing feature can be utilized to optimize settings of pre-defined presets.



Sequence Control

Sequence control by managing tightening preset # & screw number, time delay, Input & Output provides automation without PLC or sequence control device.

Can configure up to 15 presets and 15 models, consisting of up to 10 steps for each model. This feature can be extended up to 99 presets and 99 models with the optional TPM touch screen.

Example

Step 1 - Input

Detect work piece arrival on the position.

Step 2 - Delay

Time delay 0.5 second to the next step

Step 3 - Output

Lock the work piece with air cylinder

Step 4 - Tightening

Tightening total 7 with Preset #12

Step 5 - Output

Release the work piece from air cylinder lock



Sample Program of Sequence Control



STEP



STEP



STEP



STEP



STEP

Modbus Protocol Communication

MDC provides the Modbus RTU for RS232 and Modbus TCP/IP for the Ethernet port connection together.

Modbus RTU

Slave ID	F Code	Data	CRC
----------	--------	------	-----

Modbus TCP/IP ADU

Transaction ID	Protocol ID	Length	Unit ID	F Code	Data	CRC
----------------	-------------	--------	---------	--------	------	-----

ADC provides the Modbus RTU for RS422 and Modbus TCP/IP for the Ethernet port connection together. ADC provides the synchronized fastening feature for up to 31 spindle drivers.

Free PC Software "ParaMon"

- Provides easy parameter setting, data monitoring & analysis.
- 2 channel real time curve display for torque, speed, angle.
- Torque capability analysis for mean value, standard deviation, CP and CPK.
- Auto data output on every event in Modbus protocol.

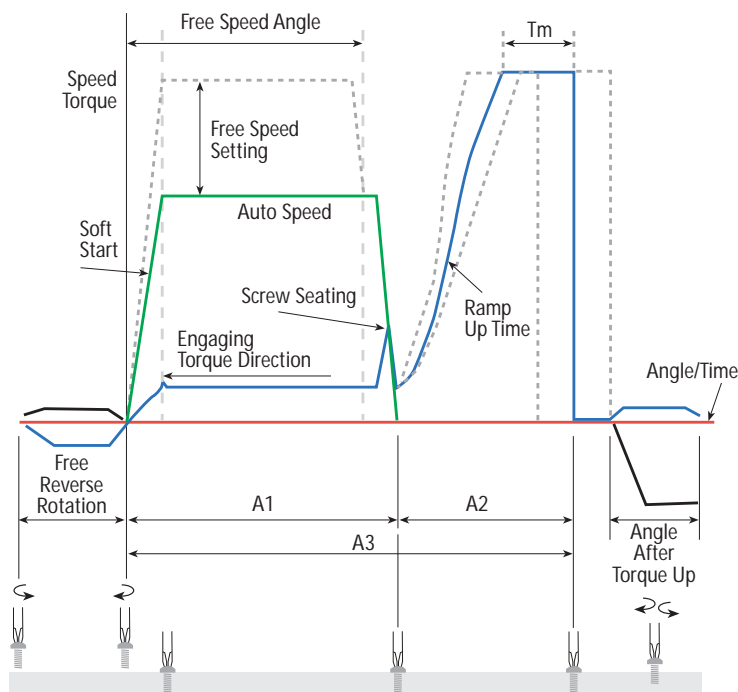

Fastening Parameter Setting

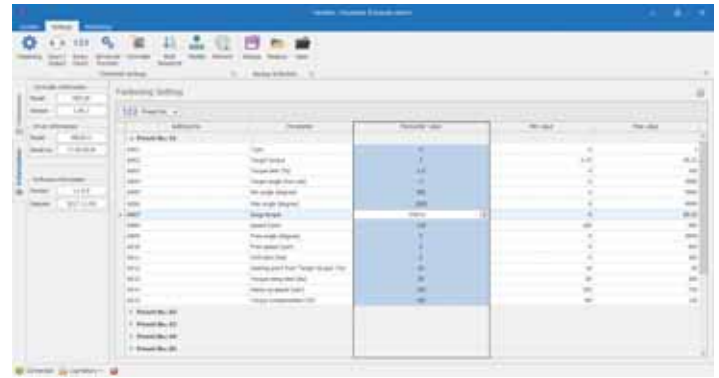

Process Capability Analysis

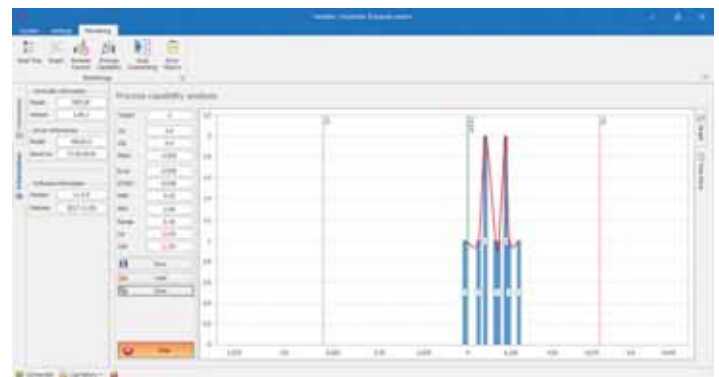

Remote Control Monitoring



Real-Time Graph Monitoring (2 channel)



MDC- Controllers

for MD Electric Screwdrivers

Features

- Preset selection capability: Front panel or 25P I/O
- Angle Control: 0.1 - 10 turns
- 15 Preset Parameters: Torque, Speed, Soft Start & Angle
- Auto detection of connected driver when controller is powered on*
- Error display: Error code display (3 groups)
- Fastening Quality Control: OK/NG monitoring of screw fastening by preset pattern of angle and/or time
- PC based program for parameter settings, monitoring and real time output
- Front panel 4.3" D3 Color LCD with touch screen
- Communication 1 x RS232C, 1 x Ethernet
- Protocol: Modbus
- SD Card data memory slot (memory card not included).

Note: Cannot simply swap driver models without going through a few set up steps, as all of the parameter values stored with the MDC controller will be related to the prior connected electric screwdriver model.

Specifications

Input (Electric):
AC120VC / AC230V, 50/60Hz
Output (Electric): DC38V 3.5A
Dimension (WxLxH):
10 7/8" x 7 3/4" x 4 1/4"
Weight: 4.4 lbs

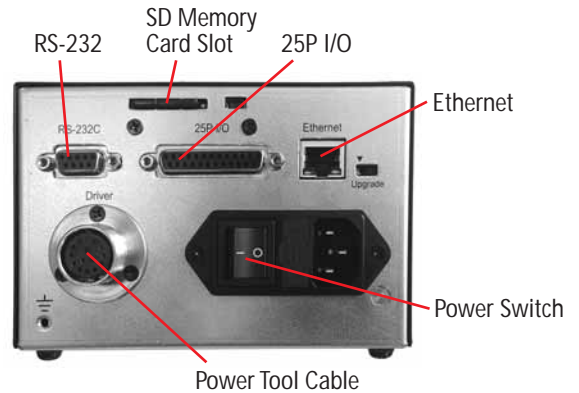

110V Controllers

MDC-26 Controller
Item # 310000

For driver models: MD-26 series

MDC-32 Controller
Item # 310001

For driver models: MD-32 series

230V Controllers

MDC-26 Controller
Item # 310002

For driver models: MD-26 series

MDC-32 Controller
Item # 310003

For driver models: MD-32 series

Controller connects to these devices via Modbus protocol RS232 or Ethernet





MD Electric Screwdrivers

In-Line Models

Model	Driver Type	Item #	Torque Ranges		Adjustable Speed RPM	Grip Dia	Length	Drive Size	Weight
			lbf.in	S.I.					
MD2601-A	Lever Start	310005	0.26 - 3.4	2.9 - 38.4 cN.m	150 - 2000	1 1/2"	9"	1/4 F/Hex	1 lb.
MD2602-A	Lever Start	310006	0.43 - 6.0	4.9 - 67.8 cN.m	150 - 2000	1 1/2"	9"	1/4 F/Hex	1 lb.
MD2604-A	Lever Start	310007	1.7 - 12.1	19.2 - 136.7 cN.m	150 - 1500	1 1/2"	9"	1/4 F/Hex	1.1 lbs.
MD2611-A	Lever Start	310008	3.4 - 29.5	38.4 - 333 cN.m	100 - 900	1 1/2"	9"	1/4 F/Hex	1.2 lbs.
MD2616-A	Lever Start	310009	4.3 - 43.4	49 - 490 cN.m	100 - 620	1 1/2"	9"	1/4 F/Hex	1.2 lbs.
MD3201-A	Lever Start	310010	0.86 - 10.4	9.7 - 117.5 cN.m	150 - 2000	1 1/2"	9"	1/4 F/Hex	1.5 lbs.
MD3202-A	Lever Start	310011	1.7 - 19	19.2 - 214.7 cN.m	150 - 2000	1 1/2"	9"	1/4 F/Hex	1.5 lbs.
MD3204-A	Lever Start	310012	3.4 - 34.7	38.4 - 392 cN.m	150 - 1500	1 1/2"	9"	1/4 F/Hex	1.9 lbs.
MD3211-A	Lever Start	310013	8.6 - 78.1	1 - 8.8 N.m	50 - 690	1 1/2"	9"	1/4 F/Hex	2 lbs.
MD3216-A	Lever Start	310014	17.3 - 121.5	2 - 13.7 N.m	50 - 470	1 1/2"	9"	1/4 F/Hex	2 lbs.
MD3236-Q	Lever Start	310015	34.7 - 243	3.9 - 27.4 N.m	50 - 210	1 1/2"	9 1/2"	3/8 Sq. Dr.	2.9 lbs.
MD3264-Q	Lever Start	310016	69.4 - 434	7.8 - 49 N.m	50 - 115	1 1/2"	9 1/2"	1/2 Sq. Dr.	2.9 lbs.

Pistol Grip Models

Model	Item #	Model	Item #	Torque Ranges		Adjustable Speed RPM	Grip Dia	Length	Drive Size	Weight
				lbf.in	S.I.					
MDP3201-AD	310017	MDP3201-A/U	310035	0.86 - 10.4	9.7 - 117.5 cN.m	150 - 2000	2"	8 1/2"	1/4 F/Hex	1.6 lbs.
MDP3202-AD	310018	MDP3202-A/U	310036	1.7 - 19	19.2 - 214.7 cN.m	150 - 2000	2"	8 1/2"	1/4 F/Hex	1.6 lbs.
MDP3204-AD	310019	MDP3204-A/U	310037	3.4 - 34.7	38.4 - 392 cN.m	150 - 1500	2"	8 1/2"	1/4 F/Hex	2 lbs.
MDP3211-AD	310020	MDP3211-A/U	310038	8.6 - 78.1	1 - 8.8 N.m	50 - 690	2"	8 1/2"	1/4 F/Hex	2.1 lbs.
MDP3216-AD	310021	MDP3216-A/U	310039	17.3 - 121.5	2 - 13.7 N.m	50 - 470	2"	8 1/2"	1/4 F/Hex	2.1 lbs.
MDP3236-QD	310022	MDP3236-Q/U	310040	34.7 - 243	3.9 - 27.4 N.m	50 - 210	2"	8 1/2"	3/8 Sq. Dr.	3.1 lbs.
MDP3264-QD	310023	MDP3264-Q/U	310041	69.4 - 434	7.8 - 49 N.m	50 - 115	2"	8 1/2"	1/2 Sq. Dr.	3.1 lbs.

Note: A/D models have power tool cable connection located at the bottom grip section of the tool.
 A/U models have power tool cable connection located at the top section of the tool.





Right Angle Models

Model	Driver Type	Item #	Torque Ranges		Adjustable Speed RPM	Grip Dia	Length	Drive Size	Weight
			lbf.in	S.I.					
MDH2604-A	Right Angle	310024	1.7 - 12.1	19.2 - 136.7 cN.m	150 - 1500	2"	12"	1/4 F/Hex	1.9 lbs.
MDH2611-A	Right Angle	310025	3.4 - 29.5	38.4 - 333 cN.m	100 - 900	2"	12"	1/4 F/Hex	2 lbs.
MDH2616-A	Right Angle	310026	4.3 - 43.4	49 - 490 cN.m	100 - 620	2"	12"	1/4 F/Hex	2 lbs.
MDH3201-A	Right Angle	310027	0.86 - 10.4	9.7 - 117.5 cN.m	150 - 2000	2"	12"	1/4 F/Hex	2.4 lbs.
MDH3202-A	Right Angle	310028	1.7 - 19	19.2 - 214.7 cN.m	150 - 2000	2"	12"	1/4 F/Hex	2.4 lbs.
MDH3204-A	Right Angle	310029	3.4 - 34.7	38.4 - 392 cN.m	150 - 1500	2"	12"	1/4 F/Hex	2.8 lbs.
MDH3211-A	Right Angle	310031	8.6 - 78.1	1 - 8.8 N.m	50 - 690	2"	12"	1/4 F/Hex	2.9 lbs.
MDH3216-A	Right Angle	310032	17.3 - 121.5	2 - 13.7 N.m	50 - 470	2"	12"	1/4 F/Hex	2.9 lbs.
MDH3236-Q	Right Angle	310033	34.7 - 243	3.9 - 27.4 N.m	50 - 210	2"	12"	3/8 Sq. Dr.	4.2 lbs.
MDH3264-Q	Right Angle	310034	69.4 - 434	7.8 - 49 N.m	50 - 115	2"	12"	1/2 Sq. Dr.	4.2 lbs.

Robotic Models

Model	Driver Type	Item #	Torque Ranges		Adjustable Speed RPM	Grip Dia	Length	Drive Size	Weight
			lbf.in	S.I.					
MDA2201-E/C	Remote Start	310042	0.08 - 0.60	0.9 - 6.7 cN.m	100 - 1000	1 1/2"	11"	4mm D-Cut	1.2 lbs.
MDA2601-E	Remote Start	310043	0.26 - 3.4	2.9 - 38.4 cN.m	150 - 2000	1 1/2"	11"	4mm D-Cut	1.2 lbs.
MDA2602-A	Remote Start	310044	0.43 - 6.0	4.9 - 67.8 cN.m	150 - 2000	1 1/2"	11"	1/4 F/Hex	1.2 lbs.
MDA2604-A	Remote Start	310045	1.7 - 12.1	19.2 - 136.7 cN.m	150 - 1500	1 1/2"	11"	1/4 F/Hex	1.3 lbs.
MDA2611-A	Remote Start	310046	3.4 - 29.5	38.4 - 333 cN.m	100 - 900	1 1/2"	11"	1/4 F/Hex	1.4 lbs.
MDA2616-A	Remote Start	310047	4.3 - 43.4	49 - 490 cN.m	100 - 620	1 1/2"	11"	1/4 F/Hex	1.4 lbs.
MDA3201-A	Remote Start	310048	0.86 - 10.4	9.7 - 117.5 cN.m	150 - 2000	1 1/2"	11"	1/4 F/Hex	1.7 lbs.
MDA3202-A	Remote Start	310049	1.7 - 19	19.2 - 214.7 cN.m	150 - 2000	1 1/2"	11"	1/4 F/Hex	1.7 lbs.
MDA3204-A	Remote Start	310050	3.4 - 34.7	38.4 - 392 cN.m	150 - 1500	1 1/2"	11"	1/4 F/Hex	2.1 lbs.
MDA3211-A	Remote Start	310051	8.6 - 78.1	1 - 8.8 N.m	50 - 690	1 1/2"	11"	1/4 F/Hex	2.2 lbs.
MDA3216-A	Remote Start	310051	17.3 - 121.5	2 - 13.7 N.m	50 - 470	1 1/2"	11"	1/4 F/Hex	2.2 lbs.
MDA3236-Q	Remote Start	310053	34.7 - 243	3.9 - 27.4 N.m	50 - 210	1 1/2"	11"	3/8 Sq. Dr.	3.4 lbs.
MDA3264-Q	Remote Start	310054	69.4 - 434	7.8 - 49 N.m	50 - 115	1 1/2"	11"	1/2 Sq. Dr.	3.4 lbs.

Note: The E/C model is equipped with a bit cushion.



ADC Controllers

for AD Electric Screwdrivers,
Robotic Spindle Models

Features

- Mountable
- Preset selection capability: Front panel or 50P I/O
- Angle Control: 0.1 - 10 turns
- 15 Preset Parameters:
Torque, Speed, Soft Start & Angle
- Auto detection of connected driver when controller is powered on*
- Error display: Error code display (3 groups)
- Fastening Quality Control:
OK/NG monitoring of screw fastening by preset pattern of angle and/or time
- PC based program for parameter settings, monitoring and real time output
- Protocol: Modbus RTU

Note: Cannot simply swap driver models without going through a few set up steps, as all of the parameter values stored with the ADC controller will be related to the prior connected electric screwdriver model.

LED Display
Preset # - Target Torque

High Voltage
Charged Alarm

AC Power Input

USB Port

RS422 Port
(link in)

RS422 Port
(link out)

50P I/O

Power Cable
to Spindle
Motor

Encoder
Cable to
Spindle

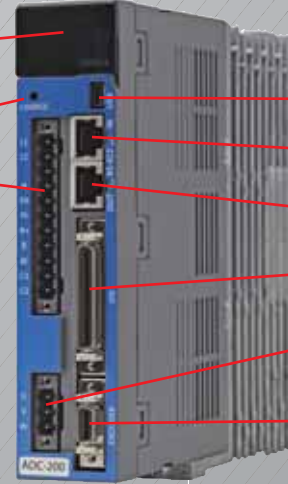

ADC-100 Controller

Item # 310072

Output (Electric): 1.4A

For driver models: AD050R

ADC-200 Controller

Item # 310073

Output (Electric): 1.7A

For driver models: AD100R

ADC-400 Controller

Item # 310074

Output (Electric): 3.0A

For driver models: AD150R

Controller connects to these devices **via Modbus protocol RS422 or USB**

TPM



PLC



PC

(Free Software ParaMon)



Specifications

Input (Electric)

AC200-230V, 50/60Hz single phase

Dimension (WxLxH)

1 1/2" x 6 3/4" x 6 1/4"

Weight

ADC-100 & 200: 2 lbs.

ADC-400: 2.1 lbs

AD150R36
AD150R64



AD150R02



AD050R01
AD100R01





AD150R04

AD150R11
AD150R16



AD150R01



AD Electric Screwdrivers

Robotic Spindle Models

Model	Driver Type	Item #	Torque Ranges		Adjustable Speed RPM	Length	Drive Size
			lbf.in	S.I.			
AD050R01-A/C	Remote Start	310060	0.4 - 5.2	4.5 - 58.7 cN.m	150 - 2000	6 7/8"	1/4 F/Hex
AD050R01-E/C	Remote Start	310061	0.4 - 5.2	4.5 - 58.7 cN.m	150 - 2000	7 1/2"	4mm D-Cut
AD100R01-A/C	Remote Start	310062	1.7 - 10.4	19.2 - 117.5 cN.m	150 - 2000	8 1/3"	1/4 F/Hex
AD150R01-A/C	Remote Start	310063	1.7 - 17.3	19.2 - 195.5 cN.m	150 - 2000	8 1/3"	1/4 F/Hex
AD150R02-A	Remote Start	310064	3.4 - 24.3	38.4 - 274/6 cN.m	150 - 2000	9"	1/4 F/Hex
AD150R04-A	Remote Start	310065	4.3 - 43.4	49 - 490 cN.m	100 - 1200	9"	1/4 F/Hex
AD150R11-A	Remote Start	310066	13 - 86.8	1.5 - 9.8 N.m	50 - 450	9 1/2"	1/4 F/Hex
AD150R16-A	Remote Start	310067	26 - 156.2	2.9 - 17.6 cN.m	30 - 310	9 1/2"	1/4 F/Hex
AD150R16-Q	Remote Start	310068	26 - 156.2	2.9 - 17.6 cN.m	30 - 310	9 1/2"	3/8 Sq. Dr.
AD150R36-Q	Remote Start	310069	43.4 - 260.4	4.9 - 29.4 N.m	30 - 140	9 1/2"	3/8 Sq. Dr.
AD150R64-Q	Remote Start	310070	86.8 - 434	9.8 - 49 N.m	30 - 75	9 1/2"	3/8 Sq. Dr.
AD150R64-Q	Remote Start	310071	86.8 - 434	9.8 - 49 N.m	30 - 75	9 1/2"	1/2 Sq. Dr.

Note: These models (A/C and E/C) are equipped with a bit cushion.



Accessories

TPM (Torque Process Monitoring) Touch Screen

This touch screen can be used for data collection, programming the MDC or ADC controller as well as monitoring the fastening process.

- 8" color TFT LCD
- Power - DC24V 1A
- Connection to MDC or ADC controller via RS232 or RS422
- Total 99 presets programs
- Total 99 model programs
- 7 inputs to select 99 programs
- Data memory in SD card
- Include same settings of MDC or ADC controller
- Easy mounting on the panel
- Fastening torque data analysis (Standard Deviation, Mean, Average, CP, CPK)



for MD-Series **Item # 310004** for AD-Series **Item # 310097**

44P I/O Wiring Box



It provides easy and convenient wiring for 12 inputs and outputs for a MDC or ADC controller by sharing one single 24V power source. (Input power: 24VDC 1A)

44P I/O Wiring Box, Item# **310055**
AC Adapter, Item# **14-GCM6913**

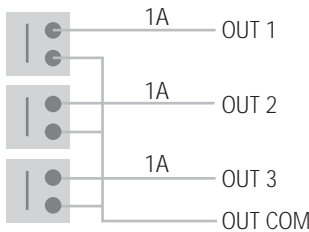

I/O Cables needed to connect to controller.

I/O Cable 3m (44P Male to 25P Male) **Item# 310057**
I/O Cable 3m (AD-50P-3M-DSUB44) **Item# 310087**

D_Sub 44P		D_Sub 44P		D_Sub 44P		D_Sub 44P		D_Sub 44P	
1	IN 1	10	IN 10	19	OUT 4	28	-	37	Out Com
2	IN 2	11	IN 11	20	OUT 5	29	Out Com	38	-
3	IN 3	12	IN 12	21	OUT 6	30	Out Com	39	-
4	IN 4	13	-	22	OUT 7	31	24V+	40	-
5	IN 5	14	IN Com	23	OUT 8	32	24V+	41	-
6	IN 6	15	IN Com	24	OUT 9	33	24V+	42	-
7	IN 7	16	OUT 1	25	OUT 10	34	-	43	-
8	IN 8	17	OUT 2	26	OUT 11	35	Out Com	44	-
9	IN 9	18	OUT 3	27	OUT 12	36	Out Com		

Auto Bit Socket Trays



A preset program or torque setting is automatically selected in the MD-Series tools once a bit or socket is removed from the bit socket tray.

Connects to MDC Controllers.
8 bit or 4 bit holder ports with sensors.

System requires 3 components

1. Select Bit Socket Tray Option:

Bit Socket Tray (4 Bit Holders)
7.5 mm, 10mm, 15 mm, 18mm
Item# 310092

Bit Socket Tray (8 Bit Holders)
7.5 mm, 10mm, 15 mm, 18mm (2 of each)
Item# 310093

2. Add SMPS Adapter

SMPS Adapter (24VDC 1A)
(It Includes a UL 2P 110V Power cord plug).
Item# 310102

Note: * For 220V, purchase Item # 310110 along with #310102

Model: Power Cord for SMPS Adapter
(220V CE Plug)
Item# 310110

3. Select Communication Cable that connects the Bit Socket Tray to the MDC Controller.

Model: Cable 25P I/O (M-M) 3 Meters
Item# 310112

Model: Cable 25P I/O (M-M) 5 Meters
Item# 310115

Bit Holders

Additional bit holder inserts can be purchased separately for the bit socket tray.



Bit Holder
(Hole Size 18mm)
Item# 310104

Bit Holder
(Hole Size 7.5mm)
Item# 310107

Bit Holder
(Hole Size 15mm)
Item# 310105

Bit Holder
(Hole Size 3mm)
Item# 310108

Bit Holder
(Hole Size 10mm)
Item# 310106

Bit Holder
(Plain)
Item# 310109

Vacuum Adapter Kits

Item # 310075

Specification:
for 1/4 F/Hex Dr, M20
Bit: Ohmi V-17, 70mmL
Screwdriver Type:
MD2601-A AD050R01-A
MD2602-A AD100R01-A
MD2604-A AD150R01-A
MD2611-A AD150R02-A
MD2616-A
MD3201-A
MD3202-A

Item # 310076

Specification:
for 1/4 F/Hex Dr, M23
Bit: Ohmi V-17, 70mmL
Screwdriver Type:
MD3204-A AD150R04-A
MD3208-A AD150R11-A
MD3210-A AD150R16-A
MD3211-A AD150R16-Q
MD3216-A

Item # 310077

Specification:
for 4mm D-Cut Dr, M20
Bit: Dia 4mm half moon
Screwdriver Type:
MD2201-E
MD2601-E
AD50R01-E

Note: MD3236, MD3264, AD150R36, and AD150R64 models are not compatible with vacuum adapter kit.

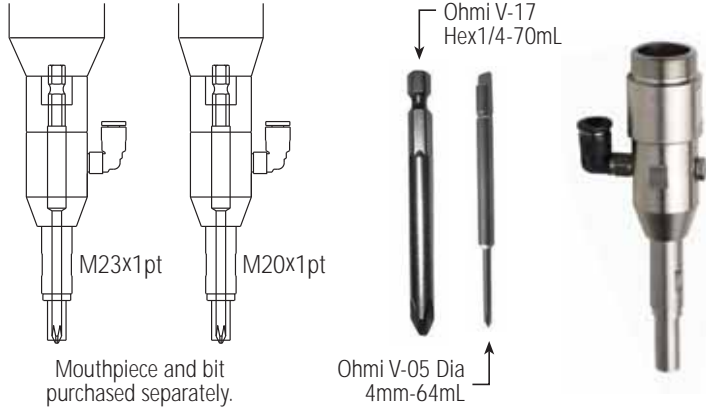

Torque Cover Bit Holders

Provides better bit concentricity for a long length bit.

Item # 310078

Specification:
for 1/4 F/Hex Dr, M20
Bit: Ohmi V-17, 70mmL
Screwdriver Type:
MD2601-A AD050R01-A
MD2602-A AD100R01-A
MD2604-A AD150R01-A
MD2611-A AD150R02-A
MD2616-A
MD3201-A
MD3202-A

Item # 310079

Specification:
for 1/4 F/Hex Dr, M23
Bit: Ohmi V-17, 70mmL
Screwdriver Type:
MD3204-A AD150R04-A
MD3208-A AD150R11-A
MD3210-A AD150R16-A
MD3211-A AD150R16-Q
MD3216-A

Item # 310080

Specification:
for 4mm D-Cut Dr, M20
Bit: Dia 4mm half moon
Screwdriver Type:
MD2201-E
MD2601-E
AD50R01-E

Note: MD3236, MD3264, AD150R36, and AD150R64 models are not compatible with torque cover bit holders.



MDC Controller Cables

RS232 Cable
(DB9 Male x DB9 Female, 2m)
Item# 773856



Cable
(USB to RS232 Adapter)
Item# 773069



I/O Cable 3m
(44P Male to 25P Male)
Item# 310057



Power Tool Cables (for MD-Series Tools only)

The driver cable connects the MD-Series electric screwdriver to the MDC controller.
Note! Each MD electric screwdriver is supplied with the standard 3 meter length cable.

3m Length Cable Item# 310056
5m Length Cable Item# 310088



Spindle Cable Sets (Power & Encoder) (for AD-Series Tools only)

Note! Each AD robotic spindle screwdriver is supplied with the standard 3 meter length spindle cable set.

Item #	Model	Desc.
310081	CB-AD01-3M	3m
310082	CB-AD01-5M	5m
310083	CB-AD01-7M	7m
310084	CB-AD01-10M	10m

ADC Controller I/O Cables (for AD-Series Tools only)

Item #	Model	Description
310085	AD-50P-3M-OPEN	Standard, with numbering
310086	AD-50P-3M-DSUB25	Connect to U-2 interface box
310087	AD-50P-3M-DSUB44	Connect to 44P I/O wiring box



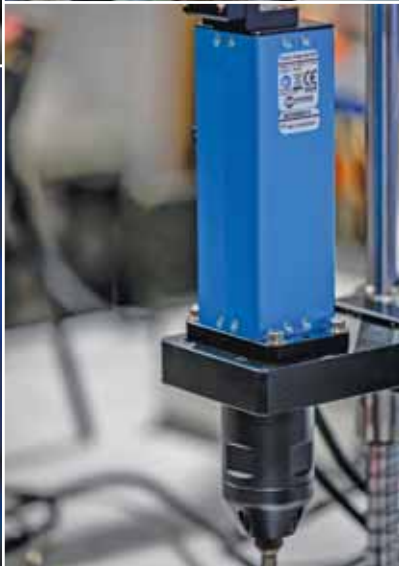

CORPORATE HEADQUARTERS

1080 North 11th Street
San Jose CA 95112
t 408.292.2214
t 800.456.1828
f 408.292.2733
sales@mountztorque.com
www.mountztorque.com

DISTRIBUTION & SERVICE CENTER

19051 Underwood Road
Foley AL 36535
t 251.943.4125
f 251.943.4979

US SALES OFFICES

Anaheim	Chicago	Los Angeles
Birmingham	Cleveland	Nashville
Boston	Dallas	Seattle
Charlotte	El Paso	San Jose

MEXICO SALES OFFICES

Cd. Juarez	Mexico DF
Chihuahua	Reynosa
Guadalajara	Tijuana
Monterrey	

EUROPE SALES OFFICE

Netherlands

FOLLOW MOUNTZ

Keep informed about our torque tool products, events and industry news. Select your favorite social media site to catch the latest news from Mountz.

Twitter: @mountztorque

Facebook: www.facebook.com/mountztorquetool

YouTube: www.youtube.com/MountzTorque

Mountz Blog: www.mountztorque.com/blog

LinkedIn: www.linkedin.com/company/mountz-inc

Google Plus: plus.google.com/+Mountztorque/posts



Twitter



Facebook



YouTube



Blog



LinkedIn



Google Plus