BM70/71 XPro User's Guide

Introduction

The BM71-XPro board is a hardware platform designed to evaluate and test the capabilities of the BM71 Bluetooth[®] RF module. The BM71-XPro board provides multiple options for rapid prototyping and developing applications. The board is supported by Atmel Studio, an integrated development platform, which provides predefined applications and examples.

Features

- USB-UART Bridge (MCP2200) for Host PC Operation
- On Board 3.3V LDO for Power Regulation
- On Board SPI Flash for Storing Firmware Images (DFU OTA)
- Test Point for GPIO Pin (P1_3)
- Reset Push Button
- DIP Switch to Control:
 - BM71 operation mode
 - LED
 - GPIO pin
- Passive RC Filters for PWM and ADC Inputs
- Atmel Studio (ASF3), to Provide Predefined Application Examples
- XPRO Extension Header
- Header Pins for Current Measurement
- Two Power Sources:
 - Micro USB
 - XPRO Connector

Table of Contents

Introduction.....	1
Features.....	1
1. Kit Contents.....	3
1.1. Reference Documentation.....	3
2. Hardware Features.....	4
2.1. Power Supply.....	4
2.2. USB-UART Bridge.....	4
2.3. XPRO Connector.....	4
2.4. DIP Switch.....	5
2.5. Reset Switch.....	5
2.6. Current Measurement Header.....	5
2.7. On-board SPI Flash.....	5
3. Module Configuration.....	7
3.1. Connecting the BM71 XPRO to MBD App in Auto Mode.....	7
3.2. Configuring the BM71 Module to Operate in Manual Mode (Host PC).....	10
3.3. Connecting the BM71-XPro to MBD App in Manual Mode (Host PC).....	14
3.4. Using the BM70/71 MCU drivers.....	23
4. Appendix A. Updating the BM71 Module Firmware.....	27
5. Appendix B. Schematics and Bill of Materials.....	28
6. Agency Certification.....	33
6.1. Europe.....	33
7. Document Revision History.....	34
The Microchip Website.....	35
Product Change Notification Service.....	35
Customer Support.....	35
Microchip Devices Code Protection Feature.....	35
Legal Notice.....	35
Trademarks.....	36
Quality Management System.....	36
Worldwide Sales and Service.....	37

1. Kit Contents

The following figure shows the layout of the BM71-XPro board and illustrates the components available in the board:

Figure 1-1. BM71-XPro Board

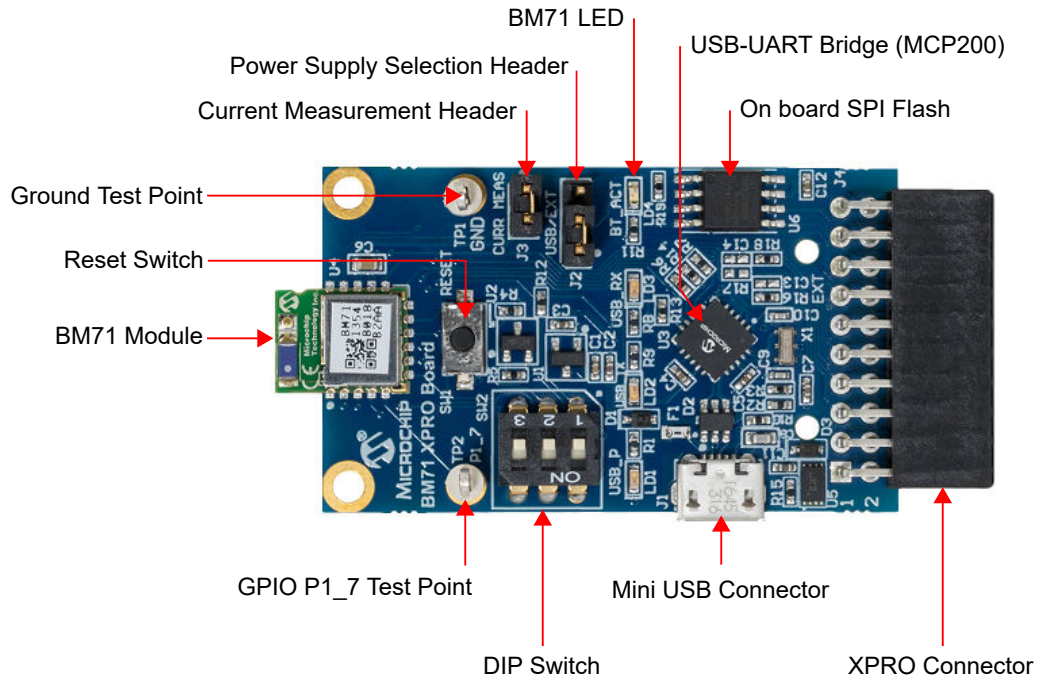

Microchip offers several smartphone applications, available for free in both the App Store (iPhone[®]) and Google Play[™] store (Android[™]), to evaluate the BM71 module. For details on the currently available apps, please refer to the BM71 XPro webpage.

1.1 Reference Documentation

For further information, refer to the following:

- *BM70/71 Bluetooth[®] Low Energy (BLE) Module Data Sheet* ([DS60001372](#))
- *BM70/71 Bluetooth[®] Low Energy Module User's Guide* ([DS50002542](#)).

2. Hardware Features

A description of some of the key features in the BM71-XPro board is provided below. Refer to [Figure 1-1](#) for details of the kit contents.

2.1 Power Supply

Power the BM71-XPro kit using any of the power sources listed below:

- Micro USB port (J1)
- XPro Connector

Use the J2 header for selecting between these power supply options using a jumper. The green LED (LD1) indicates that the board is powered by a micro-USB. The micro-USB has ESD and overcurrent protection, and the input to the module is controlled via an LDO (U1). The BM71-XPro board can be operated in a standalone mode when powered via the micro-USB.

2.2 USB-UART Bridge

The MCP2200 in the BM71-XPro board provides the option to evaluate the BM71 module in Standalone mode. By default (out of the box), the BM71 module is set to operate in Auto mode. So, the module, once powered via the micro-USB, will be able to connect to a peer Bluetooth Low Energy device and open a data pipe for data transfer. Refer to [3.1 Connecting the BM71 XPRO to MBD App in Auto Mode](#) for details. Apart from powering the board, the micro-USB port can also be used to evaluate and test the module via a host PC. Microchip provides emulation tools, such as a UI tool, auto pattern tool, and manual tool (refer to [BM71 webpage](#) for details) to evaluate the BM71 via a host PC. The BM71 module can be set to operate in Manual mode for complete control or in Auto mode for a simple data pipe application.

2.3 XPRO Connector

The BM71-XPro board has an Xplained Pro (XPRO) header to offer connectivity and control from a host MCU. The header is based on a standard extension header and its pin details are specified in the following table. The headers have a pitch of 2.54 mm. For details on the operating the BM71-XPro via a host MCU Xplained Pro board, refer to [3.3 Connecting the BM71-XPro to MBD App in Manual Mode \(Host PC\)](#).

Table 2-1. Extension Header (J1) Pin Description

Pin#	Pin name	Description
1	ID	ID Chip communication
2	GND	Ground
3	ADC1	Connected to pin P2_0 to set system configuration
4	ADC2	Connect to Reset pin of BM71
5	RTS/GPIO	Connected to host MCU RTS
6	CTS/GPIO	Connected to host MCU CTS
7	PWM+	PWM pin (+) of host MCU
8	PWM-	PWM pin (-) of host MCU
9	GPIO	Connected to GPIO pin P2_7 (TX_Ind)
10	GPIO	Connected to GPIO Pin P1_6 (RX_Ind)

.....continued		
Pin#	Pin name	Description
11	I2C SDA	
12	I2CSCL	
13	Host MCU Rx	Connects to BM71 Tx pin
14	Host MCU Tx	Connects to BM71 Rx pin
15	SPI SS	SPI SS pin of Flash memory
16	SPI MOSI	SPI MOSI pin of Flash memory
17	SPI MISO	SPI MISO pin of Flash memory
18	SPI SCK	SPI SCK pin of Flash memory
19	GND	Ground
20	Vdd	Power supply

2.4 DIP Switch

The DIP switch has three switches which provide the functions described in the following table.

Table 2-2. DIP Switch Functions

Switch#	Function
1	Manually set the BM71 system configuration. Connected to pin P2_0. <ul style="list-style-type: none"> • ON: Memory Programming mode • OFF: Application mode
2	Turn the Blue LED (LD4) ON/OFF
3	Control the GPIO pin P1_3

2.5 Reset Switch

The Reset push button is connected to the BM71 module reset line. When the Reset button is pressed, it drives the reset line to ground. The BM71-XPro board has an on-board voltage detected reset IC (MCP112) connected to the Reset pin of the BM71.

2.6 Current Measurement Header

A J3 header can be used for current measurement.. All power to the BM71-XPro is routed through these header pins. To measure the power consumption of the module, remove the jumper and replace it with an ammeter. To make sure only the power consumption of the BM71 module is measured, turn off the blue LED using switch #2 of the DIP switch.

2.7 On-board SPI Flash

An SST25VF080B SPI Flash memory is included in the BM71-XPro board for nonvolatile firmware storage. This can be used to update the device firmware for the BM71 or the host MCU.

Note: BM71 Xplained Pro board is intended for use for development, demonstration or evaluation purposes only. It is not a finished appliance, nor is it intended for incorporation into or reference design for finished appliances that are made commercially available.

Every effort has been made to minimize electromagnetic emissions from the product. However, under certain conditions, the system (this product connected to a host application circuit via Xplained Pro extension header for communicating with External SPI Flash) may emit individual electromagnetic component frequencies which exceed the maximum values allowed by the standards. The frequency and magnitude of the emissions will be determined by several factors, including layout and routing of the application with which the product is used. The recommendation is to add external series resistors on the Xplained Pro Extension Header SPI signals to the External SPI Flash if the product causes emissions above the permissible limits of the standard. For reference for the BM71 module placement and layout guidelines please refer the BM71 Module datasheet.

3. Module Configuration

The BM70/71 module supports following modes, which affect the overall Bluetooth Low Energy and hardware behavior:

- **Auto operation configuration or Auto mode:** By default, the BM70/71 module is set to operate in the Auto mode. The Auto mode restricts the available Bluetooth Low Energy operations by only allowing the Bluetooth Low Energy peripheral to act as a raw data pipe. This is compatible with hosts who only require the BM70/71 module to act as a virtual UART cable between the host and the remote peer device.
- **Manual operation configuration or Manual mode:** Manual operation provides the host MCU a lot more control and functional options over the BM71 Bluetooth Low Energy protocol and operation in comparison to the Auto Operation mode. This configuration is used by a host MCU to leverage the flexibility and feature set offered by both the Bluetooth Low Energy protocol and the BM71 module (for example: private services and characteristics).

Note: For more details, refer to the Section 1.1 Operation Overview in the *BM70/71 Bluetooth Low Energy Module User's Guide (DS50002542)*.

The simplest method to start evaluating the BM71 is to connect it to a host PC that supports USB CDC virtual COM (serial) ports and operates in Auto mode. In this mode, the user can directly connect to the BM71 from a peer device (phone app) and open a raw data pipe. Refer to [3.1 Connecting the BM71 XPRO to MBD App in Auto Mode](#) for connection procedure. See [3.2 Configuring the BM71 Module to Operate in Manual Mode \(Host PC\)](#) and [3.3 Connecting the BM71-XPro to MBD App in Manual Mode \(Host PC\)](#) for an example of Manual mode of operation.

3.1 Connecting the BM71 XPRO to MBD App in Auto Mode

Hardware/Software required:

- BM71-XPro board; Mini-USB cable.
- A PC host supporting USB CDC virtual serial port. BM71-XPro board uses MCP2200 USB to UART bridge. The drivers can be downloaded from <http://www.microchip.com/MCP2200>.
- Terminal Emulator application. TeraTerm or CoolTerm is recommended.
- Microchip MBD app for iOS or Android. Available in:
 - [App Store](#) (iOS) for iPhones.
 - [Google Play Store](#) for Android phones.

By default, the BM71 module is set to operate in Auto mode. For details on the Auto mode of operation on the BM71 module, refer to section 1.1.2.1 in the *BM70/71 User's Guide (DS50002542)*.

The procedure to connect the BM71-XPro board to a peer device (phone/table) via host PC is given below:

1. Ensure that the BM71-XPro board is configured as follows:
 - 1.1. Jumper on the J2 header is closed to select USB power option.
 - 1.2. The current measurement jumper on J3 is present.
 - 1.3. Switch 1 (system configuration) on the DIP switch is set to OFF.
 - 1.4. Switch 2 (blue LED) on the DIP switch is set to ON.
2. Connect the BM71-XPro board to a host PC using the mini-USB cable. Ensure that green LED (LD1) is solid ON indicating USB power.
3. Connect BM71-XPro to a PC host using micro-USB cable.
 - 3.1. Verify the virtual COM port is enumerated on a host PC. If the COM port does not enumerate, the MCP2200 drivers may be missing from the host PC. If needed, the drivers can be downloaded from the www.microchip.com/MCP2200 webpage.
 - 3.2. Press the Reset button (SW1) and verify that the blue LED (LD4) is flashing intermittently.
4. Start the Terminal Emulator software. In this example, TeraTerm is used. Configure the serial port settings of the enumerated COM port as shown in the following figure.

Figure 3-1. TeraTerm Serial Port Setup

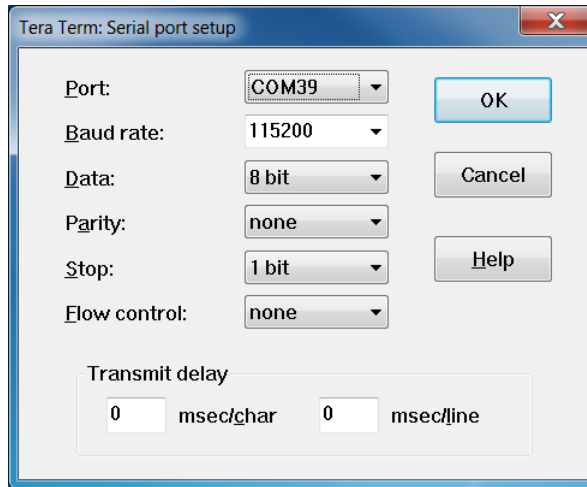

5. Open the MBD app on the phone/tablet. Ensure that the Bluetooth is turned ON in the device.
6. On Dashboard, select “BM70”, see the following figure.

Figure 3-2. MBD Dashboard

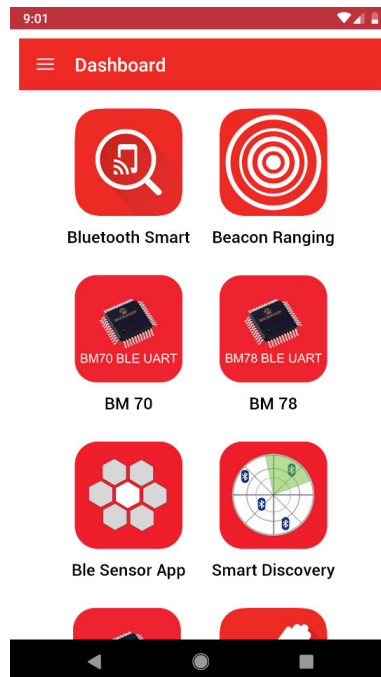

7. In the follow-up screen, click **Scan** and “Scan” again at the bottom.
8. Once the scanning process completes, the BM71 module should appear as “BM71_BLE” by default.

Figure 3-3. MBD Scanning Process

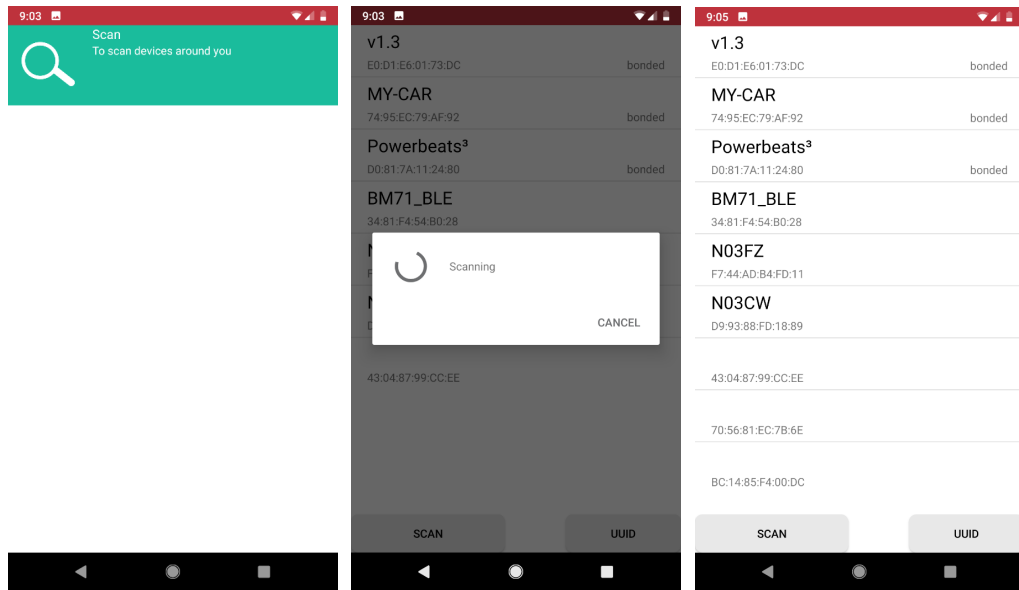

9. Click on the “BM71_BLE” to start a connection process. Once connected, the transparent UART service available on the BM71 module should show up.

Figure 3-4. MBD Connecting to BM71 XPRO

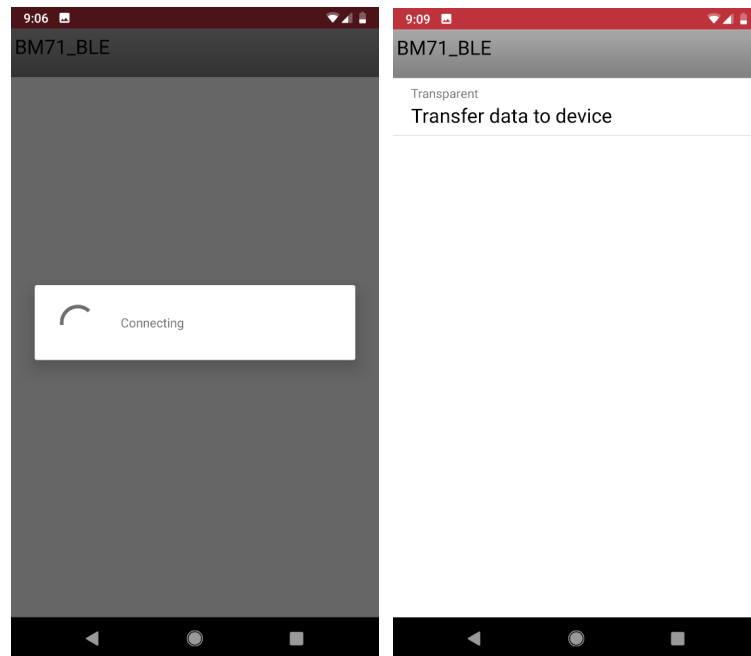

10. Click on “Transfer data to device”. The Transparent UART screen should open (see following figure). The data pipe is now open.

Figure 3-5. MBD Data Pipe

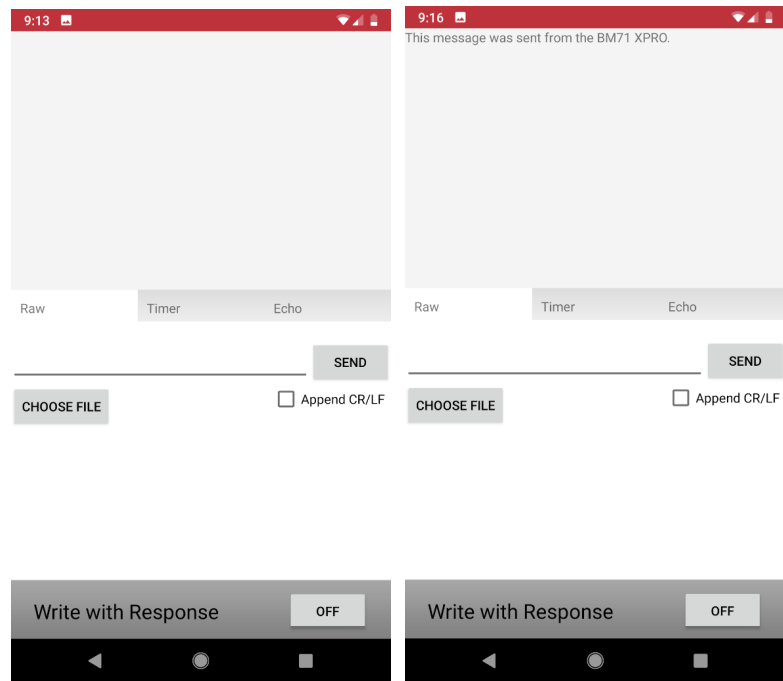

11. In the serial emulator application (TeraTerm), enter any text and this should show up in the transparent UART page in the app.

3.2 Configuring the BM71 Module to Operate in Manual Mode (Host PC)

Hardware/Software required:

- BM71-XPro board; Mini-USB cable.
- A PC host supporting USB CDC virtual serial port. BM71-XPro board uses MCP2200 USB to UART bridge. The drivers can be downloaded from <http://www.microchip.com/MCP2200>.
- BM71 emulator tools: UI Tool. These tools can be download from the [BM71 webpage](#).

The procedure to change the BM71 to Manual mode via host PC is given below:

1. Ensure that the BM71-XPro board is configured as follows:
 - 1.1. Middle jumper on J2 is closed to select USB power option.
 - 1.2. The current measurement jumper on J3 is present.
 - 1.3. Switch 2 (blue LED) on the DIP switch is set to ON.
2. Connect the BM71-XPro board to the host PC using the mini-USB cable. Ensure that the green LED (LD1) is solid ON indicating USB power.
3. Connect BM71-XPro board to the host PC using micro-USB cable. Verify the virtual COM port is enumerated on the host PC. If the COM port does not enumerate, the MCP2200 drivers may be missing from the host PC. If needed, the drivers can be downloaded from the <http://www.microchip.com/MCP2200> web page.
4. Set switch 1 (system configuration) on the DIP switch to ON. Press the Reset button (SW1). The blue LED (LD4) should turn to a solid ON.
5. Open the UI tool (see the following figure) and Click on 'Load'.

Figure 3-6. UI Tool

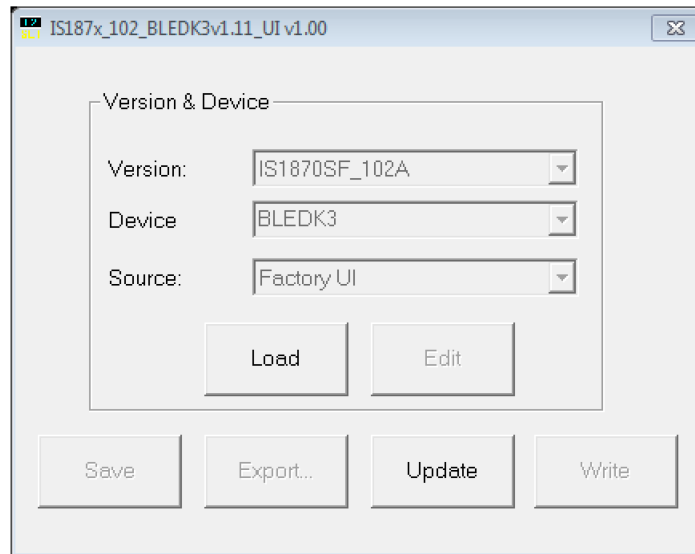

6. In the 'Loading Option' dialog box, select "Load Text File" option (see the following figure)
Figure 3-7. Loading Option

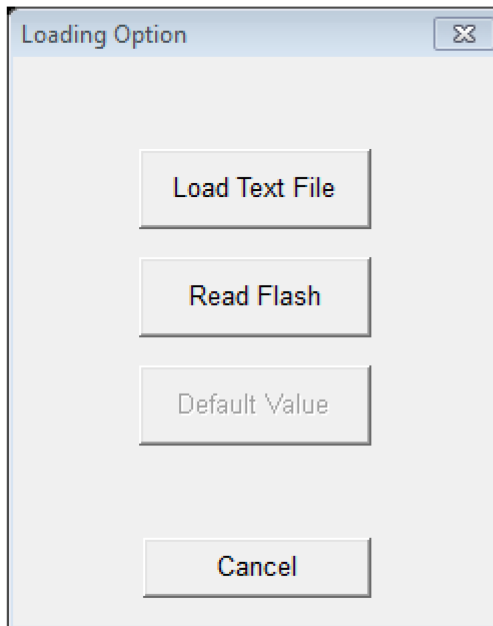

7. In the file browser, select "IS1871SF_102_BLEDK3v1.11_UI v1.00(BM71)_default.txt"
8. In the UI tool dialog box, click on "Edit"

Figure 3-8. UI Tool - Editing

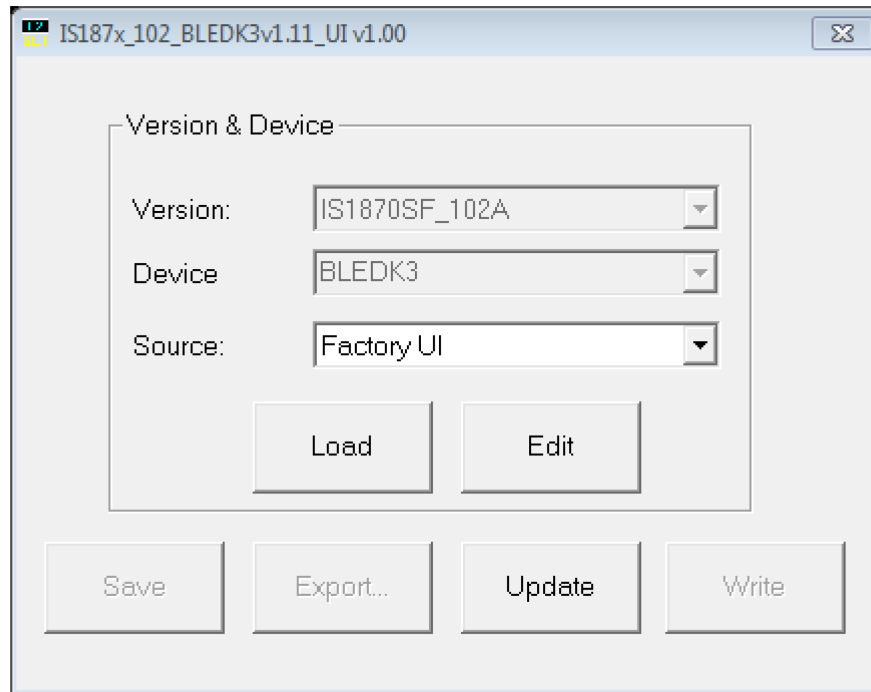

9. Click 'OK' in 'Feature' dialog box.
10. In the UI Tool, under the 'System Setup':
 - 10.1. Set the UART_RX_IND (Low power operation) to 'Disable' from the drop-down menu.
 - 10.2. Set the Operation mode to "Manual Pattern" under the 'Operation mode setting' section.
11. Click 'Finish'
12. In the UI Tool, click 'Write' (see following figure)

Figure 3-9. UI tool: Select 'Write'

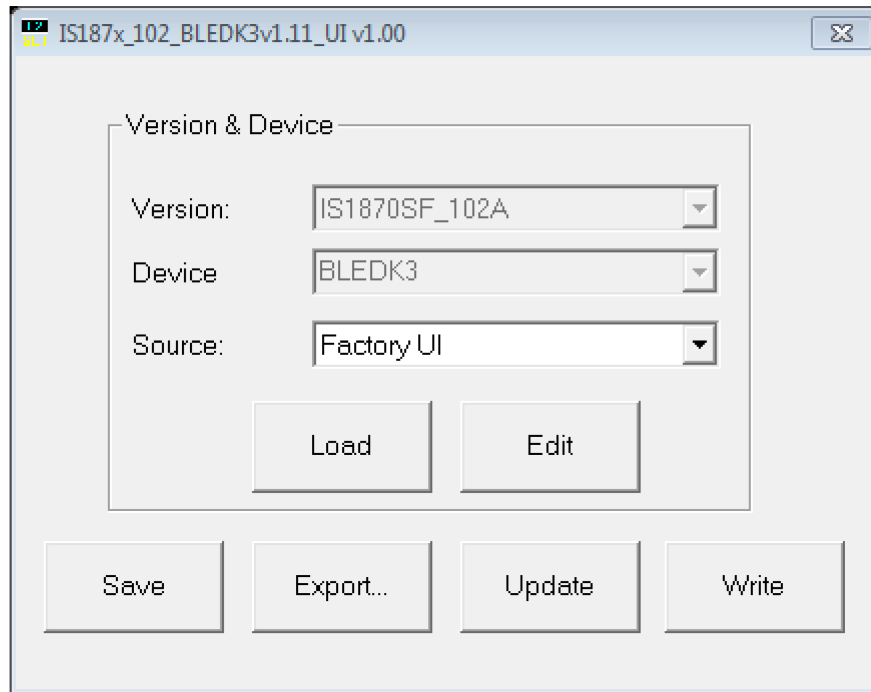

13. In the 'Read/Write Flash' dialog box, select an appropriate COM port and click on 'Write'. In the confirmation window, click 'Yes' to update EFLASH.

Figure 3-10. Read / Write Flash

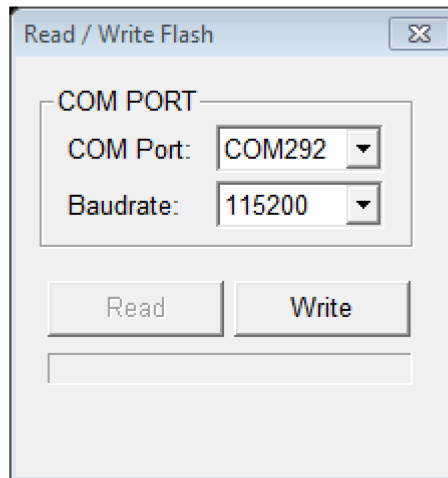

14. After the successful Flash write, a confirmation message will be flashed as shown in the following figure.

Figure 3-11. Write Confirmation

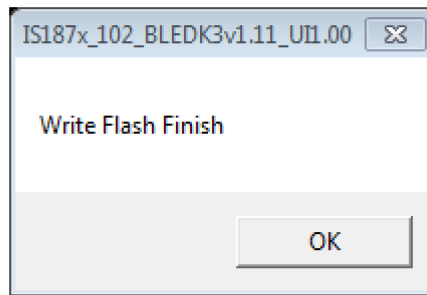

15. Close the UI tool.
16. Set switch 1 (system configuration) on the DIP switch to ON. Press the Reset button (SW1). The blue LED (LD4) should blink intermittently.
17. The module is now set to work in Manual mode.

3.3 Connecting the BM71-XPro to MBD App in Manual Mode (Host PC)

Hardware/Software required:

- BM71-XPro board; Mini-USB cable.
- A PC host supporting USB CDC virtual serial port. BM71-XPro board uses MCP2200 USB to UART bridge. The drivers can be downloaded from <http://www.microchip.com/MCP2200>.
- BM71 emulator tools: UI Tool and Manual pattern tool. These tools can be download from the [BM71 webpage](#).
- Microchip MBD app for iOS or Android. Available in:
 - [App Store](#) (IOS) for iPhones
 - [Google Play Store](#) for Android devices

To configure the module to operate in Manual mode, follow the procedure described in the [3.2 Configuring the BM71 Module to Operate in Manual Mode \(Host PC\)](#). The procedure to connect to a peer device (phone/tablet) in Manual mode is given below:

1. Ensure that the BM71-XPro board is configured as follows:
 - 1.1. Middle jumper on J2 is closed to select USB power option.
 - 1.2. The current measurement jumper on J3 is present.
 - 1.3. Switch 1 (system configuration) on the DIP switch is set to OFF.
 - 1.4. Switch 2 (blue LED power) on the DIP switch is set to ON.
2. Connect the BM71-XPro board to the host PC using the mini-USB cable. Ensure that green LED (LD1) is solid ON indicating USB power.
3. Connect BM71-XPro to the host PC using micro-USB cable. Verify the virtual COM port is enumerated on host PC. If the COM port does not enumerate, the MCP2200 drivers may be missing from the host PC. If needed, the drivers can be downloaded from the <http://www.microchip.com/MCP2200> webpage.
4. Press the Reset button (SW1) and verify that the blue LED (LD4) is flashing intermittently.
5. Open the manual pattern tool. Select the enumerated COM port for the BM71-XPro board in the COM port drop down list (top-left - see following figure) and click 'Connect'. The 'Connect' button should change to 'Disconnect' upon a successful connection.

Figure 3-12. Manual Test Tool

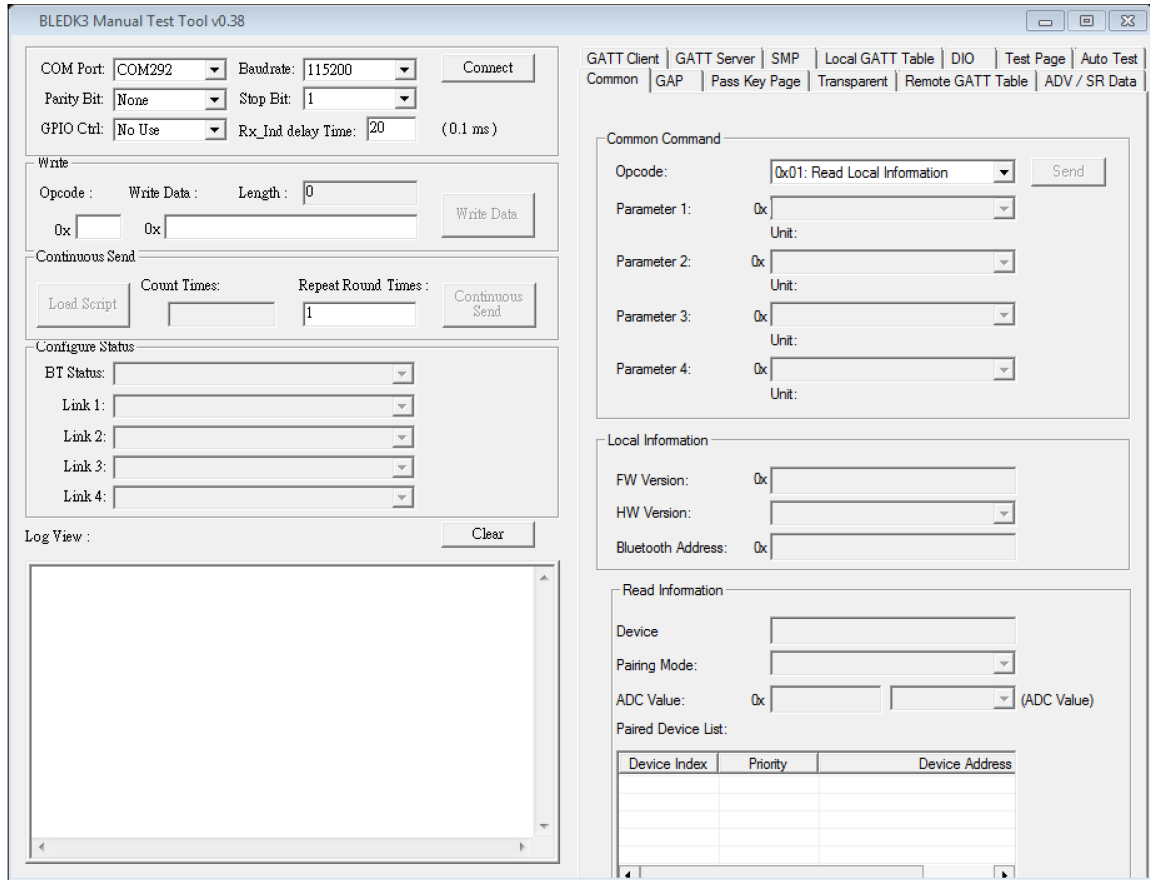

6. To verify the module information (not mandatory), in the 'Common' tab (left side), under the 'Common Command' section, select '0x01: Read Local Information' for the 'Opcode' field. Click 'Send' (see following figure). The module will respond with the Bluetooth MAC address, firmware version and hardware version. The response is shown in the "Log view" window.

Figure 3-13. Read Local Information

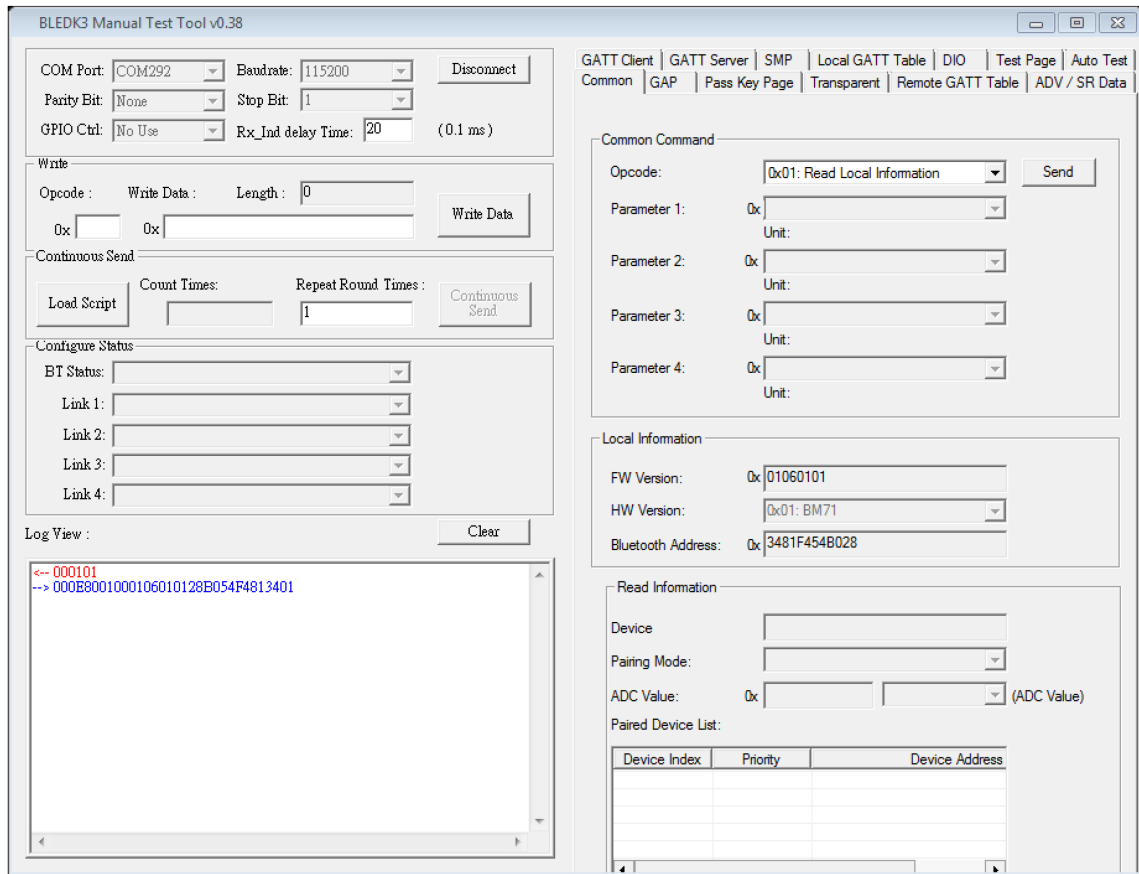

7. To begin advertising, enter the 'GAP' tab, under the 'GAP Command' section, select the following options for each field (see following figure):
 - 7.1. Select "0x1C: Set Adv Enable" for Opcode field.
 - 7.2. Select "0x01: Enter Standby Mode" for the Standby mode field.
 - 7.3. Click "Send".
8. Once the module enters the Standby mode (started advertising), the BT Status field will be updated (see the following figure).

Figure 3-14. Start Advertising

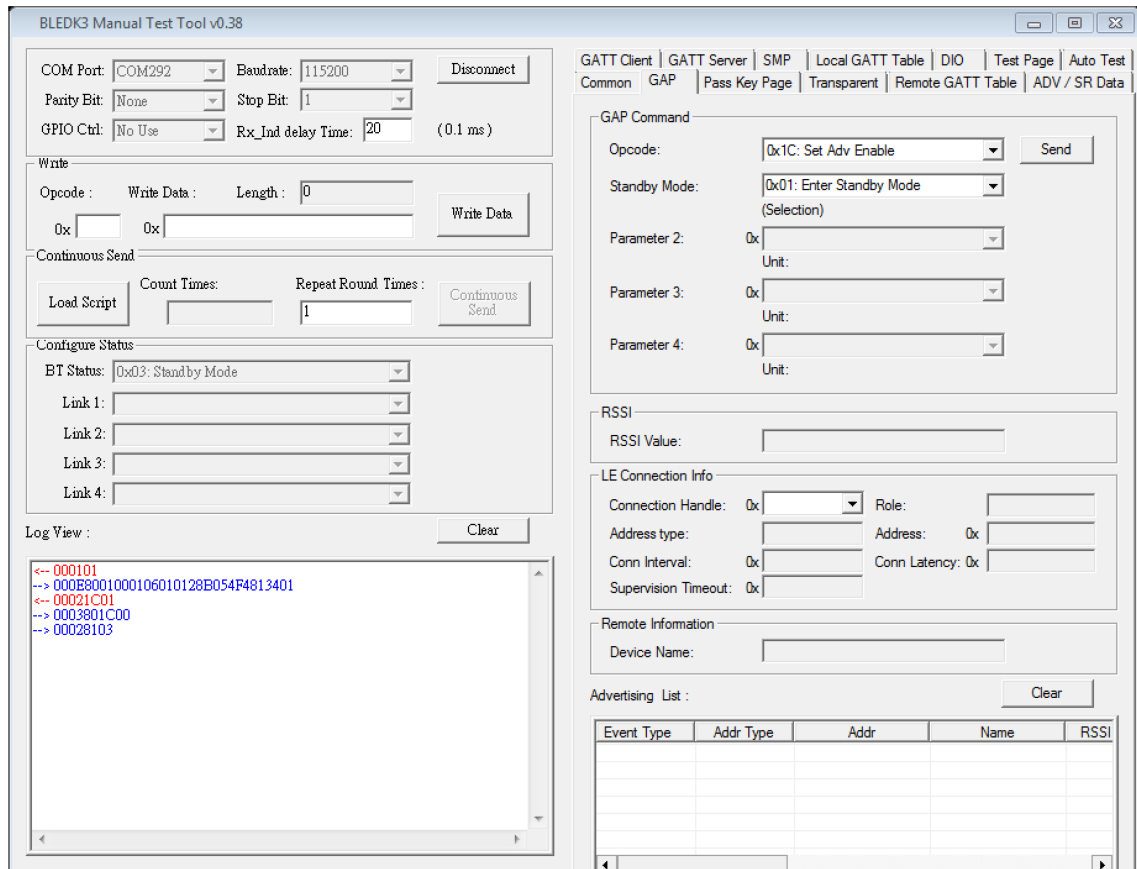

9. Open the MBD app on the phone/tablet. Ensure that the Bluetooth is turned ON in the device.
10. On Dashboard, select "BM70", see the following figure.

Figure 3-15. MBD Dashboard

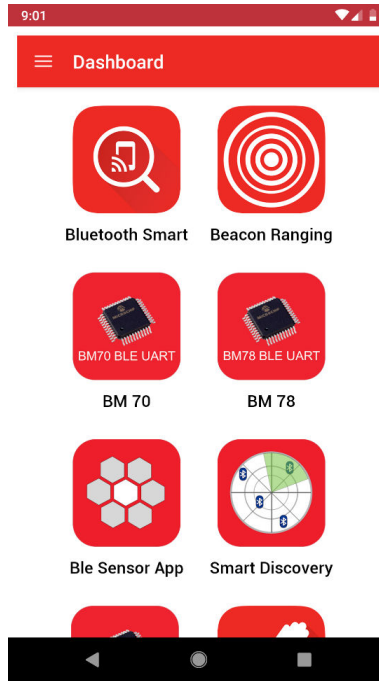

11. In the follow-up screen, click **Scan** and “Scan” again at the bottom.
12. Once the scanning process completes, the BM71 module should appear as “BM71_BLE” by default.

Figure 3-16. MBD Scanning Process

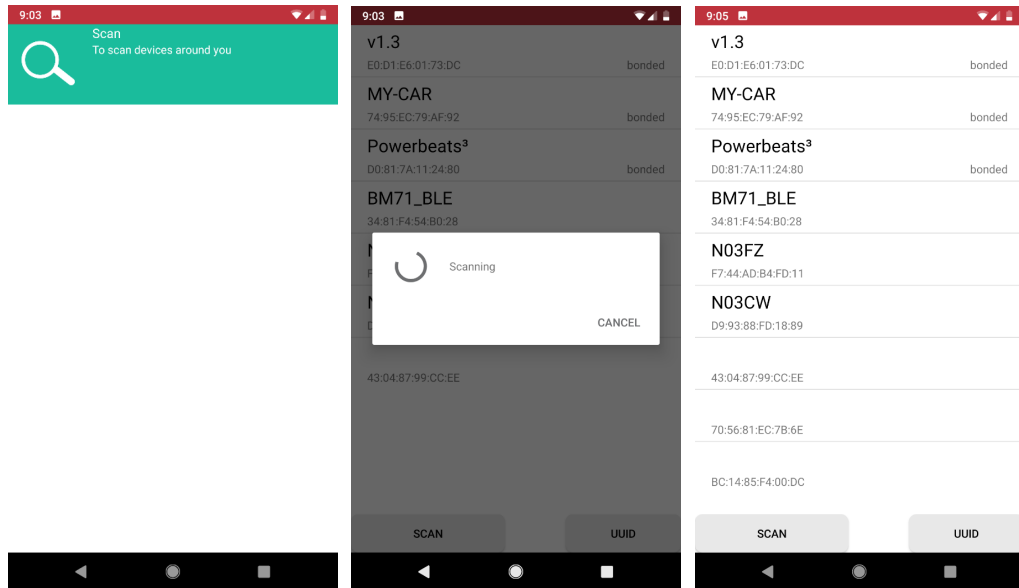

13. Click on the “BM71_BLE” to start a connection process. Once connected, the transparent UART service available on the BM71 module should show up.

Figure 3-17. MBD Connecting to BM71-XPro

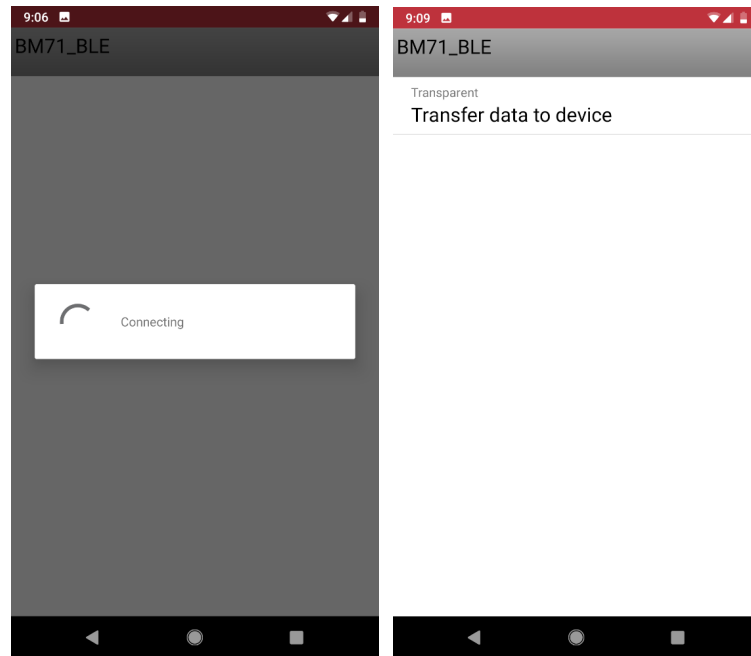

14. The manual tool should show the connection details once the connection from the peer device (phone/tablet) is successfully executed (see the following figure).

Figure 3-18. Connecting from a Peer Device

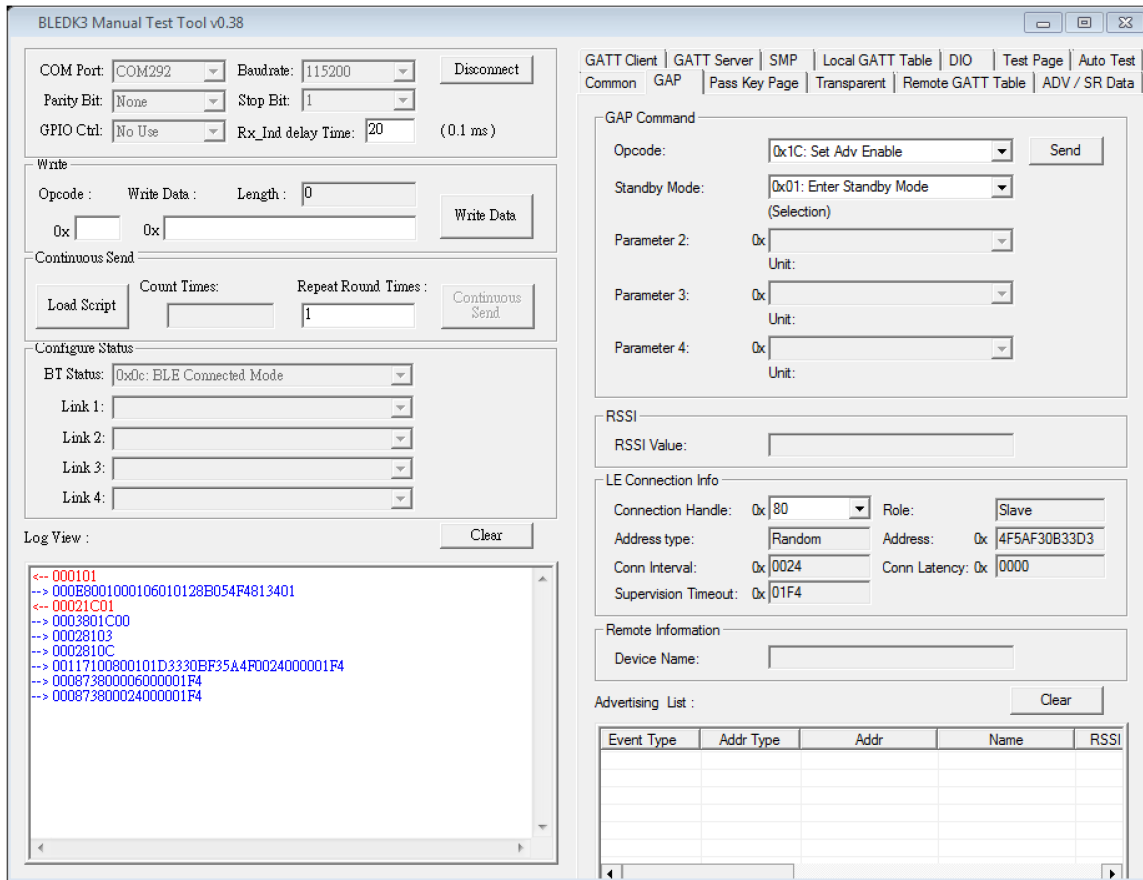

- On the MBD app, click on "Transfer data to device". The Transparent UART screen should open. Ensure that the 'Write with Response' in the app is set to ON. The data pipe is now open.

Figure 3-19. MBD Data Pipe

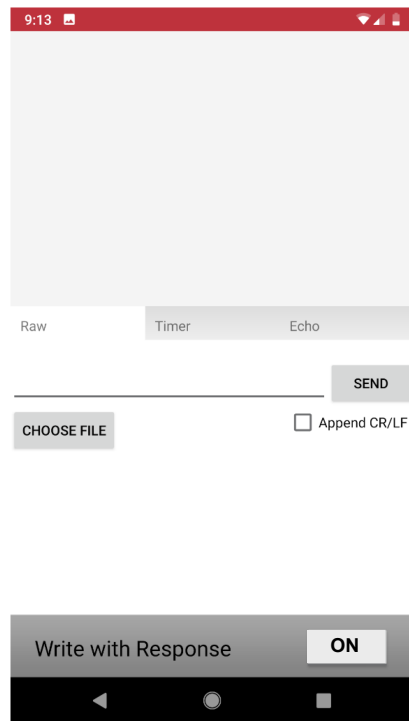

16. The manual tool should provide the message for the data pipe in the log view (see following figure).

Figure 3-20. Open a Transparent UART Data Pipe

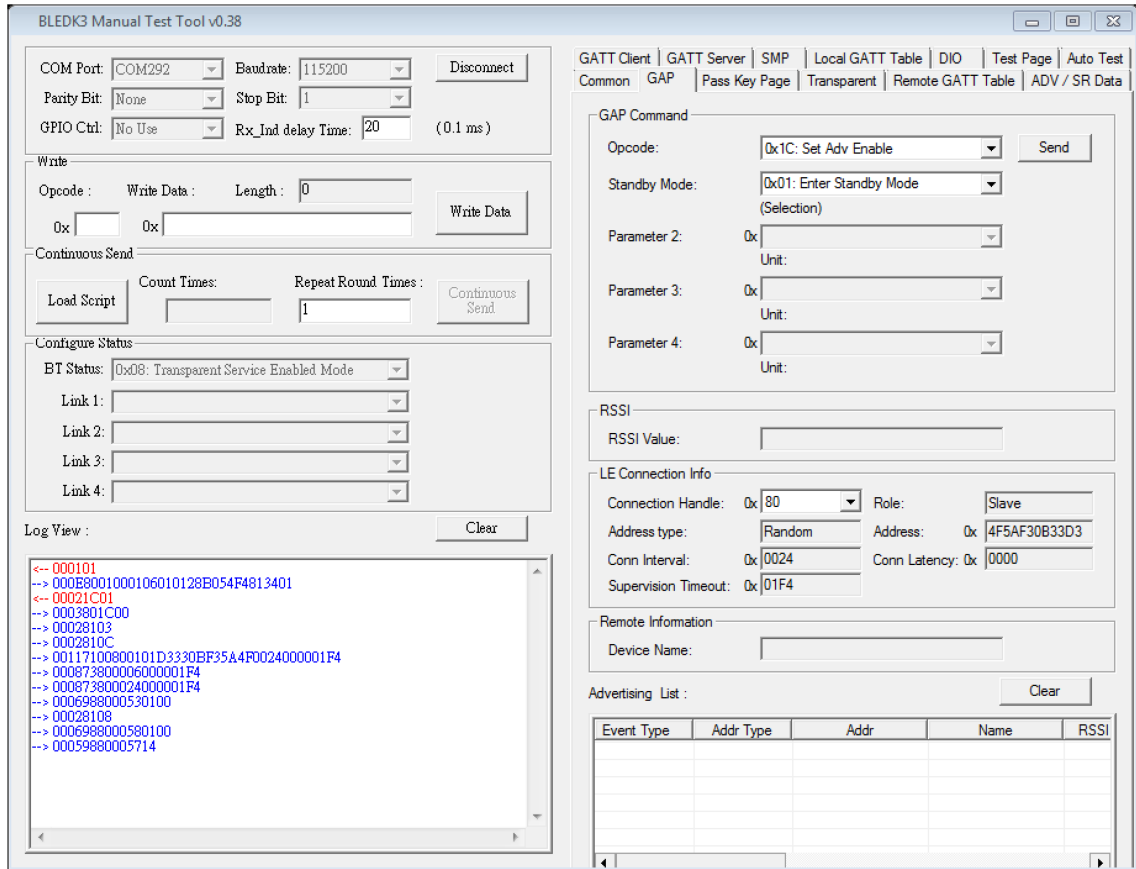

- Go to the 'Transparent' tab on the manual tool. Check operation of the data pipe, by entering data in the app or in the 'Send Data' field in the manual tool.

Figure 3-21. Transparent UART Data Pipe Testing

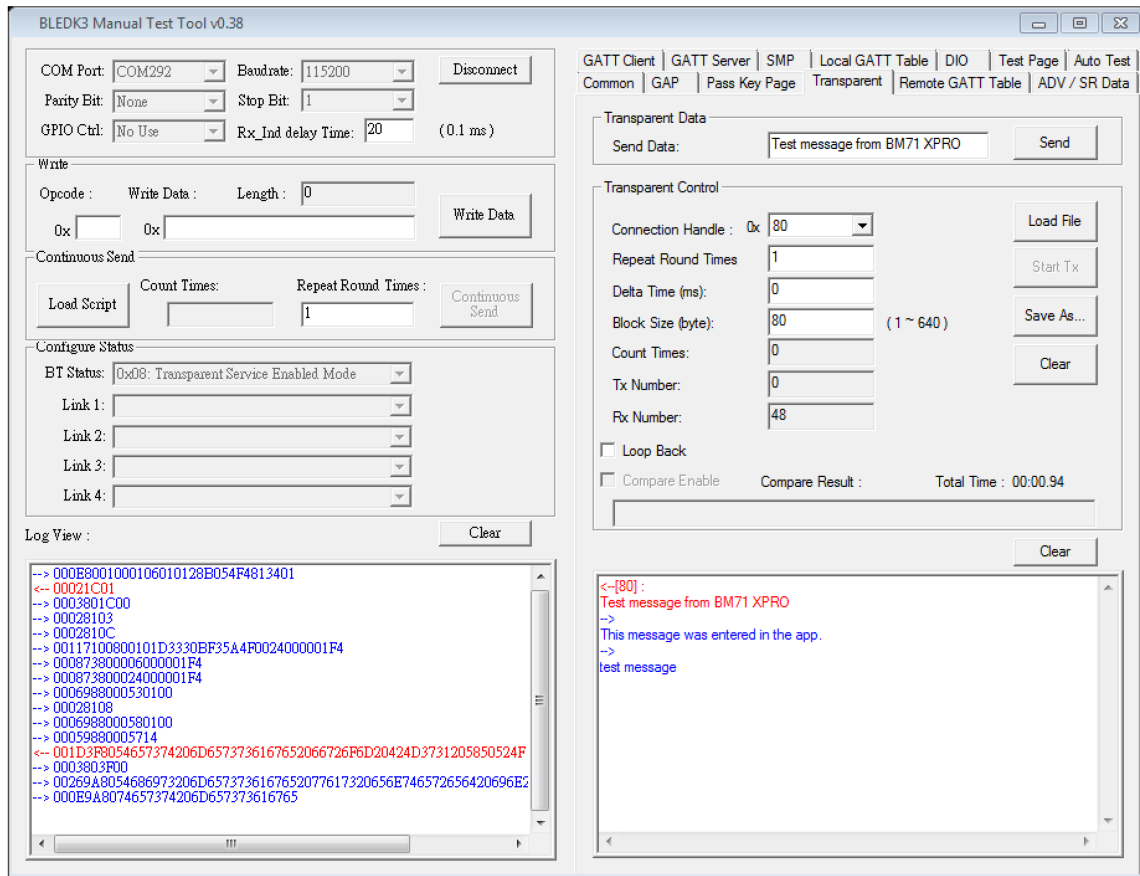

18. The transparent UART data pipe is now operational in Manual mode.

3.4 Using the BM70/71 MCU drivers

Microchip offers a library of MCU drivers for the BM70/71 modules integrated into the Harmony and ASF3 for MPLAB® and Atmel Studio, respectively. This section describes how to access the BM71 MCU drivers from ASF3 library in Atmel Studio.

Hardware/software required:

- Atmel Studio 7.x7.0 with ASF3 installed (version 3.44.0 or later).
- SAML21 Xplained Pro board.
- BM71-XPro board.

To use the BM71 MCU drivers in ASF3, the BM71-XPro board needs to be connected to EXT1 header of the BM71-XPro board (see following figure).

Figure 3-22. BM71-XPro Board Connected to the SAML21 Xplained Pro

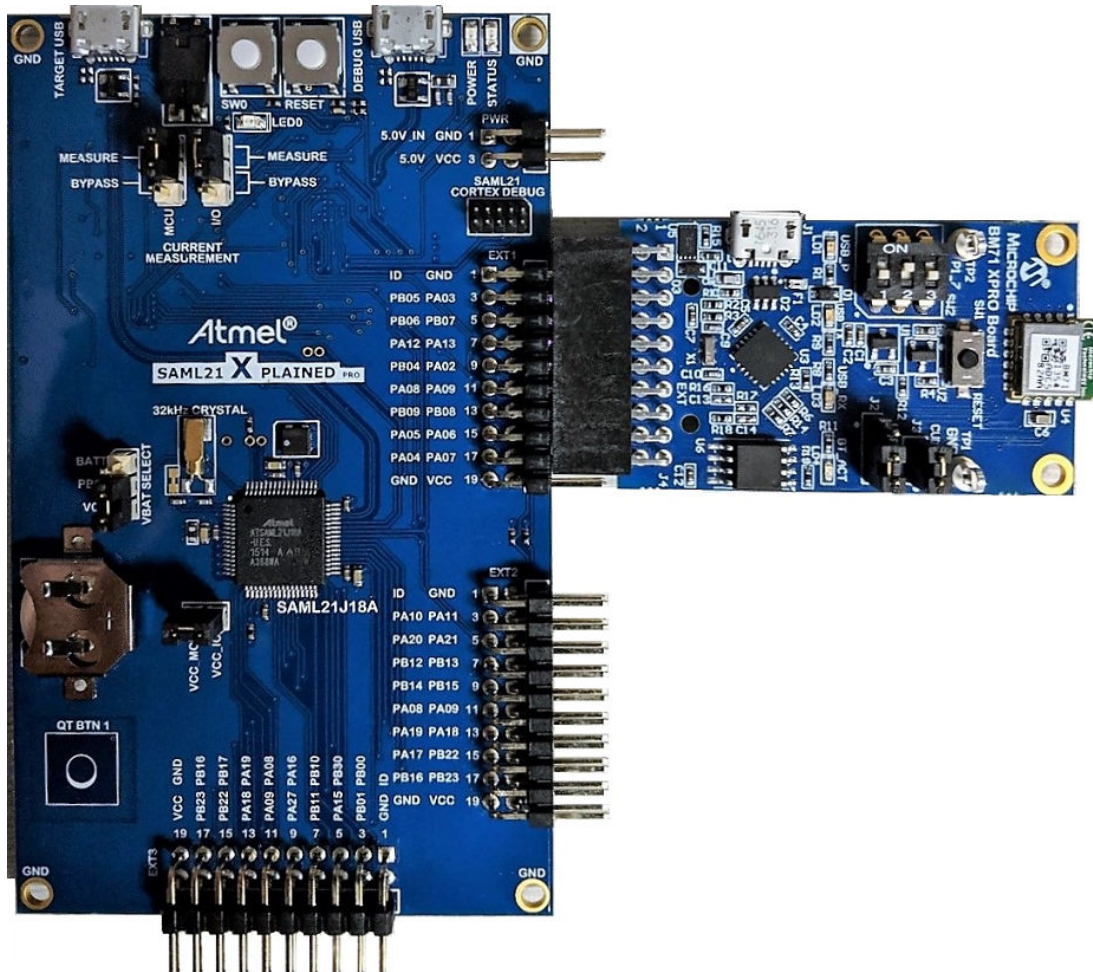

1. Connect to the BM71-XPro board to EXT1 header of the SAML21 Xplained Pro board. Open Atmel Studio software. On the top menu, select 'File' → 'New' → 'Example Project'.
2. In the 'New Example Project' dialog box
 - 2.1. Select Device Family: as "SAML21" from the drop down list and enter 'ble_host_sdk' in the search field as shown in the following figure. The list of example projects should be available in the 'All Projects' tab. (If not visible, try clicking on the horizontal triangle to expand the list under 'Atmel-Atmel Corp.' header).

Figure 3-23. Opening an Example Project for BM71-XPro Board

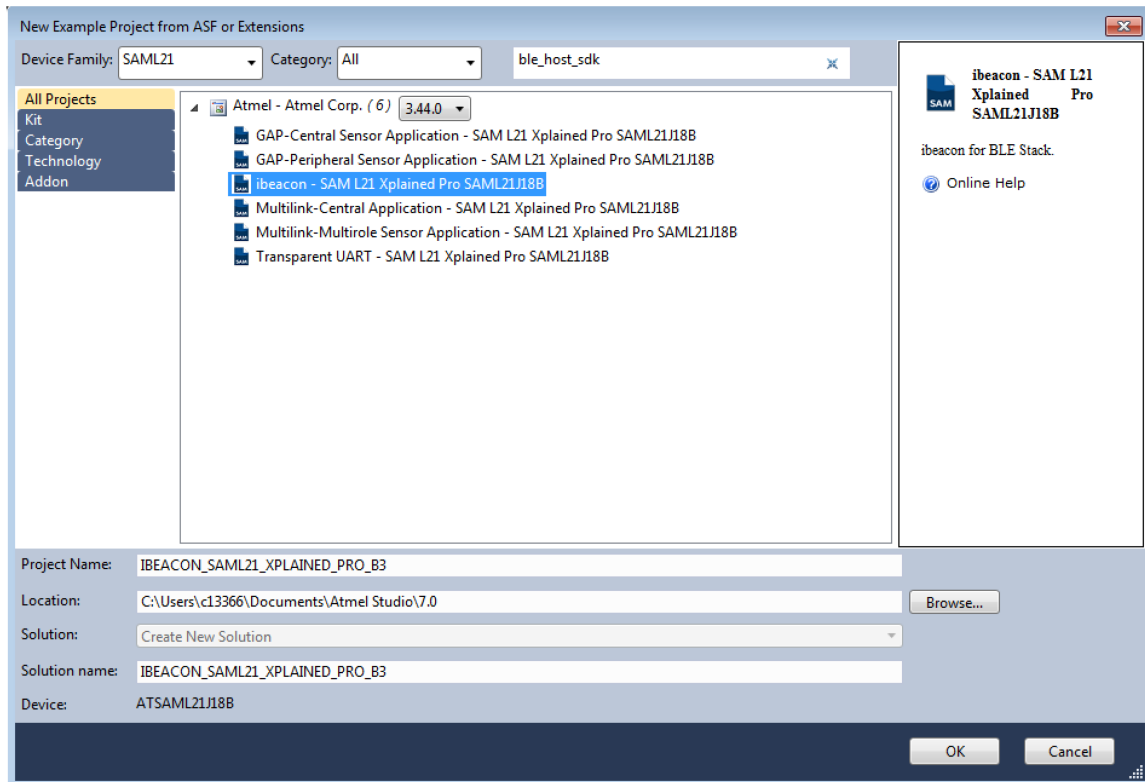

3. The list of available example projects is provided. Select any project to get started. In the preceding figure, the iBeacon was selected as an example. Click **OK** in the succeeding dialog box to accept the terms and conditions. The iBeacon example will now be loaded as can be seen in the following Solution Explorer window.

Figure 3-24. Solution Explorer window in Atmel Studio

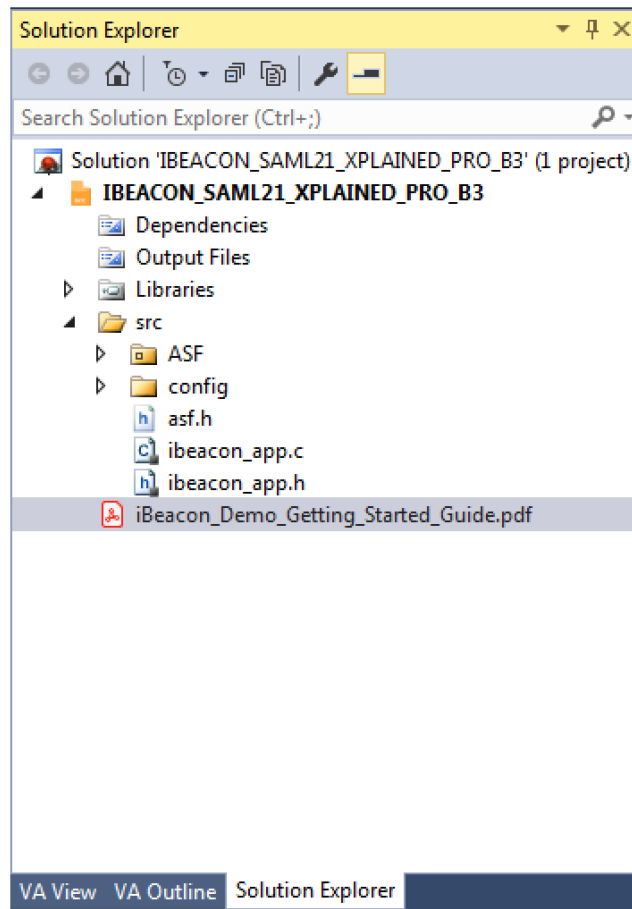

Note: For more instructions on executing the project, click on the 'iBeacon_Demo_Getting_Started_Guide.pdf' file for details.

4. Follow the instructions in the getting started guide to build, load, and test the project.

4. Appendix A. Updating the BM71 Module Firmware

The firmware in the BM71 module can be updated using a PC Tool isupdate.exe over the USB port. The latest BM71 firmware images and the isupdate.exe tool are available from the [BM71 product webpage](#).

The procedure to change/update the firmware on the BM71 module using the host PC utility is given below:

1. Download the firmware zip file from the [BM71 webpage](#) and extract the contents. The zip file contains the isupdate.exe utility and a folder including the firmware images.
2. Connect the BM71-XPro board to the host PC using the micro-USB cable.
3. Verify that switch#1 of the DIP switch (SW2) is set to ON position. Press Reset button (SW1) and verify that the blue LED (LD4) is solid ON indicating that the BM71 is in Memory Programming mode.
4. Launch the isupdate.exe application. In the tool:
 - 4.1. Select the COM port used by the BM71-XPro board.
 - 4.2. Verify that other settings (baud, memory type, and address) are set as follows:
 - 4.2.1. Baudrate: 115200
 - 4.2.2. Memory type/subtype: Flash/Embedded
 - 4.2.3. Address: 0000

Figure 4-1. Firmware Update Tool

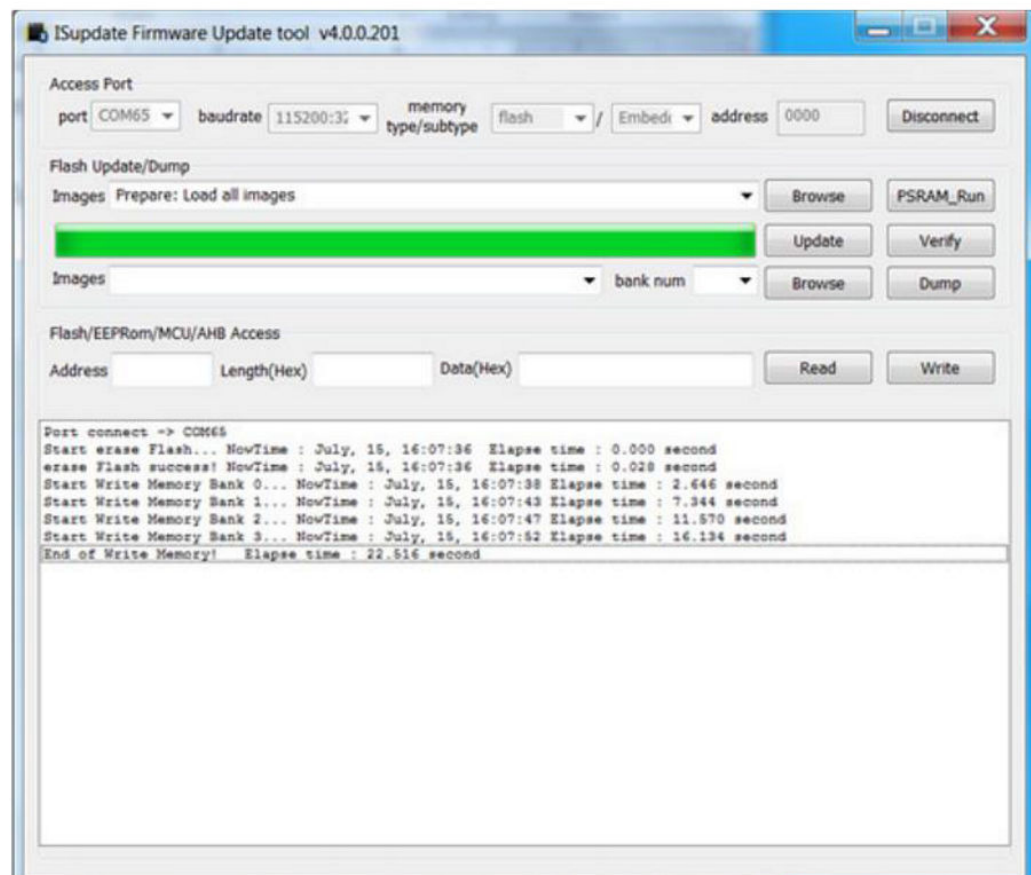

- 4.3. Click the Connect button and verify that the “Port connect -> COMxx” is displayed in the text box.
- 4.4. Verify firmware update is successfully completed. The “End of Write Memory” message is displayed.
- 4.5. Click the Disconnect button to close the COM port.
- 4.6. Set switch 1 in DIP switch SW2 to the ‘1’ position for Application mode.

5. Appendix B. Schematics and Bill of Materials

The schematic and the Bill of Materials (BOM) for the BM71-XPro board are provided below.

Figure 5-1. BM71-XPro Schematic

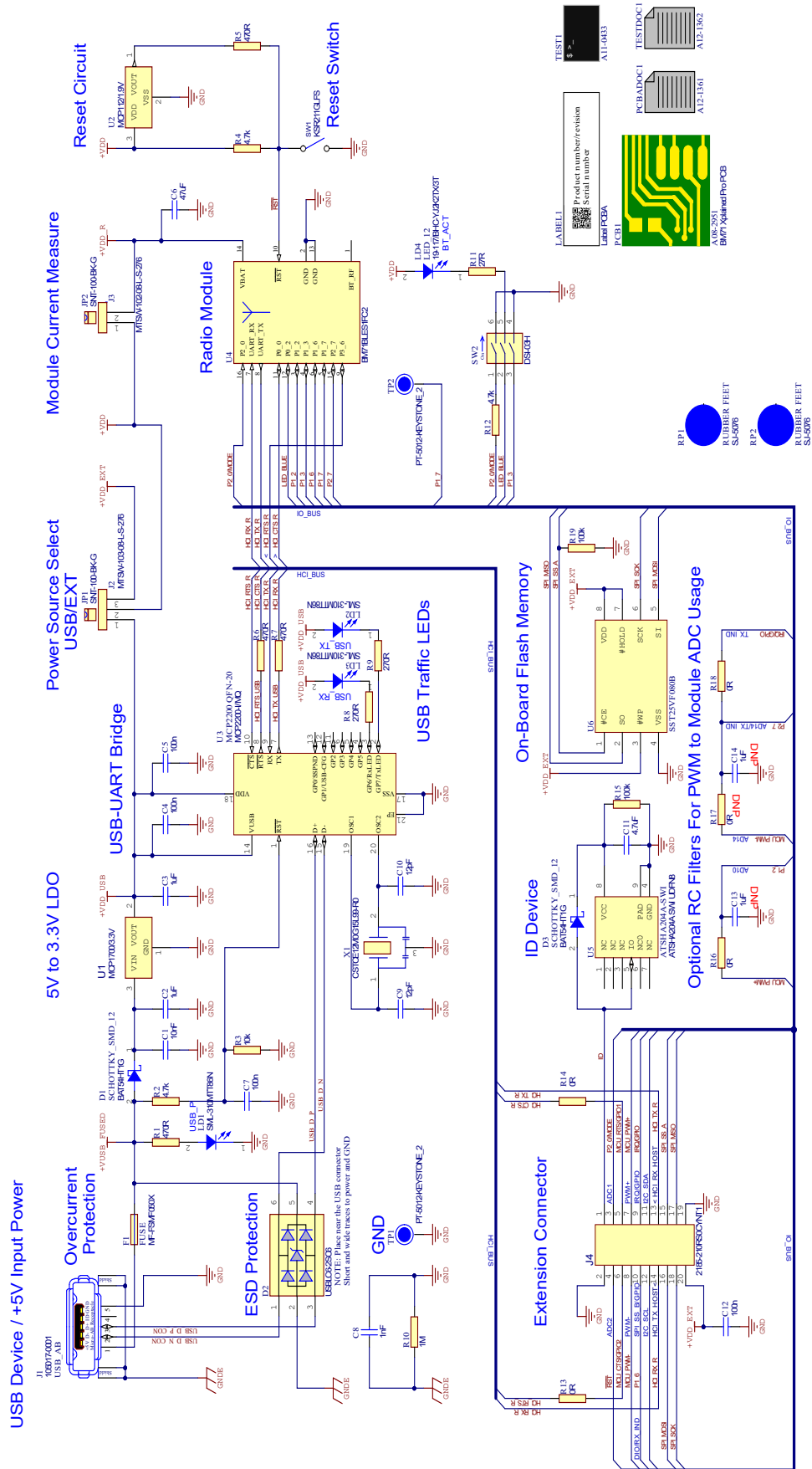

Table 5-1. Bill of Materials

Quantity	Designator	Description_	Manufacturer 1	Manufacturer Part Number	Supplier 1	Supplier Part Number 1	Populated	Quantity	MCHP-ID
1	C1	CAP CER 10000pF 50V 10% X7R SMD 0402	Murata	GRM155R71E103KA01D	Digi-Key	490-1312-2-ND	YES	1	CAP1071
2	C2, C3	CAP CER 1uF 16V 10% X5R SMD 0402	Murata	GRM155R61C105KE01D	Digi-Key	490-10453-2-ND	YES	2	CAP1065
4	C4, C5, C7, C12	CAP CER 0.1uF 16V 10% X7R SMD 0402	Murata	GRM155R71C104KA88D	Digi-Key	490-3261-2-ND	Yes	4	CAP1033
1	C6	CAP CER 47uF 6.3V 20% X5R SMD 0603	Murata Electronics North America	GRM188R60J476ME15D	Digi-Key	490-13247-1-ND	YES	1	CAP1661
1	C8	CAP CER 1000pF 200V 10% X7R SMD 0603	AVX Corporation AVX Corporation	06032C102KAT2A	Digi-Key	478-1194-1-ND	YES	1	CAP1591
2	C9, C10	CAP CER 12pF 50V 1% NP0 SMD 0402	Murata Electronics North America	GRM1555C1H120FA01D	Digi-Key	490-6196-2-ND	YES	2	CAP1367
1	C11	CAP CER 4.7uF 10V 10% X5R SMD 0402	TDK Corporation	C1005X5R1A475K050BC	Digi-Key	445-13820-1-ND	YES	1	CAP1684
0	C13, C14	CAP CER 1uF 16V 10% X5R SMD 0402	Murata	GRM155R61C105KE01D	Digi-Key	490-10453-2-ND	DNP	0	CAP1065
2	D1, D3	DIO SCKY BAT54 900mV 300mA 40V SOD-323	STMicroelectronics	BAT54JFILM	Digi-Key	497-7163-1-ND	Yes	2	DIODE0182
1	D2	DIO TVSARR USBLC6-2SC6 5.25V SMD SOT-23-6	STMicroelectronics	USBLC6-2SC6	Digi-Key	497-5235-1-ND	YES	1	DIODE1148
1	F1	RES FUSE 750mA 8V 0.2s Poly SMD 1206	Littelfuse Inc.	1206L075THYR	Digi-Key	F3370CT-ND	YES	1	RES1648
1	J1	CON USB2.0 MICRO-B FEMALE TH/SMD R/A	FCI	10118194-0001LF	Digi-Key	609-4618-1-ND	YES	1	CON1383
1	J2	CON HDR-2.54 Male 1x3 Gold 5.84MH TH VERT	FCI	68000-103HLF	Digi-Key	609-3461-ND	Yes	1	CON1105
1	J3	CON HDR-2.54 Male 1x2 Gold 5.84MH TH VERT	FCI	77311-118-02LF	Digi-Key	609-4434-ND	Yes	1	CON1108
1	J4	CON HDR-2.54 Female 2x10 Rotated 180Degrees Gold TH RT ANGLE	Sullins Connector Solutions	PPPC102LJBN-RC	Digi-Key	S5563-ND	YES	1	CON1532
2	JP1, JP2	MECH HW JUMPER 2.54mm 1x2	3M	969102-0000-DA	Digi-Key	3M9580-ND	MECH	2	HW1006
1	LABEL	LABEL, ASSY W/REV LEVEL (SMALL MODULES) PER MTS-0002			Dev Tools		MECH	1	08-00028
3	LD1, LD2, LD3	DIO LED GREEN 2.2V 25mA 18mcd Diffuse SMD 0603	Lumex	SML-LX0603GW-TR	Digi-Key	67-1549-1-ND	YES	3	LED0120

.....continued										
Quantity	Designator	Description_	Manufacturer 1	Manufacturer Part Number	Supplier 1	Supplier Part Number 1	Populated	Quantity	MCHP-ID	
1	LD4	DIO LED BLUE 2.8V 20mA 15mcd Clear SMD 0603	Lite-On	LTST-C193TBKT-5A	Digi-Key	160-1827-1-ND	YES	1	DIODE1056	
4	R1, R5, R6, R7	RES TKF 470R 5% 1/16W SMD 0402	Panasonic	ERJ-2GEJ471X	Digi-Key	P470JCT-ND	Yes	4	RSMT0337	
3	R2, R4, R12	RES TKF 4.7k 5% 1/10W SMD 0402	Panasonic	ERJ-2GEJ472X	Digi-Key	P4.7KJCT-ND	Yes	3	RSMT0734	
1	R3	RES TKF 10k 5% 1/10W SMD 0402	Panasonic	ERJ-2GEJ103X	Digi-Key	P10KJCT-ND	Yes	1	RSMT0735	
2	R8, R9	RES TKF 270R 5% 1/10W SMD 0402	Panasonic	ERJ-2GEJ271X	Digi-Key	P270JTR-ND	YES	2	RES1027	
1	R10	RES TKF 1M 5% 1/16W SMD 0402	Yageo	RC0402JR-071ML	Digi-Key	311-1.0MJRCT-ND	YES	1	RES1019	
1	R11	RES TKF 27R 5% 1/10W SMD 0402	Panasonic Electronic Components	ERJ-2RKF27R0X	Digi-Key	P27.0L1TR-ND	YES	1	RES1823	
4	R13, R14, R16, R18	RES TKF 0R SMD 0402	Panasonic	ERJ-2GE0R00X	Digi-Key	P0.0JCT-ND	Yes	4	RSMT0730	
2	R15, R19	RES TKF 100k 5% 1/10W SMD 0402	Panasonic	ERJ-2GEJ104X	Digi-Key	P100KJCT-ND	Yes	2	RSMT0737	
0	R17	RES TKF 0R SMD 0402	Panasonic	ERJ-2GE0R00X	Digi-Key	P0.0JCT-ND	DNP	0	RSMT0730	
2	RP1, RP2	MECH HW RUBBER PAD Cylindrical flat top D8H2.8 Black	3M	SJ5076BLACK	Farnell	1165061	MECH	2	MECH0087	
1	SW1	SWITCH TACT SPST 12V 50mA RS-282G05A3-SM RT	C&K Components	RS-282G05A3-SM RT	Digi-Key	CKN1038ACT-ND	YES	1	SWITCH1057	
1	SW2	SWITCH DIP 3 SPST 24VDC 25MA DSS-03-B-PF TH	ROKI ELECTRONICS CO., LTD.	DSS-03-B-PF	ROKI ELECTRONICS CO., LTD.	DSS-03-B-PF	YES	1	SWITCH1042	
2	TP1, TP2	CON TP LOOP Black TH	Keystone	5011	Digi-Key	36-5011-ND	YES	2	MISC0025	
1	U1	MCHP ANALOG LDO 3.3V MCP1700T-3302E/TT SOT-23-3	Microchip	MCP1700T-3302E/TT	Microchip	MCP1700T-3302E/TT	Yes	1	MIC0598	
1	U2	MCHP ANALOG VOLATGE DETECTOR 1.9V MCP112T-195I/TT SOT-23-3	Microchip Technology	MCP112T-195I/TT	Mouser	579-MCP112T-195I/TT	YES	1	MIC7057	
1	U3	MCHP INTERFACE USB UART MCP2200-I/MQ QFN-20	Microchip Technology	MCP2200-I/MQ	Digi-Key	MCP2200-I/MQ-ND	YES	1	MIC6326	
1	U4	MCHP RF BLUETOOTH BM71BLES1FC2 MODULE-16	Microchip	BM71BLES1FC2	Microchip	BM71BLES1FC2	YES	1	MIC6577	
1	U5	IC Crypto Element SHA-256 1-Wire ATSHA204A-MAHCZ-T UDFN-8					YES	1	IC1400	

.....continued										
Quantity	Designator	Description_	Manufacturer 1	Manufacturer Part Number	Supplier 1	Supplier Part Number 1	Populated	Quantity	MCHP-ID	
1	U6	MCHP MEMORY SERIAL FLASH 4M 50MHz SST25VF040B-50-4I-SAF SOIC-8	Microchip	SST25VF040B-50-4I-SAF-T	Microchip	SST25VF040B-50-4I-SAF-T	YES	1	MIC5599	
1	X1	RESONATOR 12MHz 0.1% SMD CSTCE-G	Murata	CSTCE12M0G15L99-R0	Digi-Key	490-7848-1-ND	YES	1	OSC1027	

6. Agency Certification

This equipment (SAM R34 Xplained Pro Evaluation Kit/A09-3167) is intended for evaluation purposes only. The following regulatory notices are to cover the requirements under the regulatory approval.

6.1 Europe

This equipment (A09-3167) has been assessed under the Radio Equipment Directive (RED) for use in European Union countries. A Declaration of Conformity must be issued for each of these standards and kept on file as described in Radio Equipment Directive.

Furthermore, the manufacturer must maintain a copy of the module's documentation and ensure the final product does not exceed the specified power ratings, antenna specifications, and/or installation requirements as specified in the user manual. If any of these specifications are exceeded in the final product, a submission must be made to a notified body for compliance testing to all required standards.



Important: On account of the nature of radio equipment, the height of the CE marking affixed to radio equipment may be lower than 5 mm, provided that it remains visible and legible. More detailed information about CE marking requirements, refer [Article 19](#) of "DIRECTIVE 2014/53/EU OF THE EUROPEAN PARLIAMENT AND OF THE COUNCIL" of 16 April 2014.

SIMPLIFIED EU DECLARATION OF CONFORMITY

Hereby, Microchip Technology Inc. declares that the radio equipment type [A09-3110] is in compliance with Directive 2014/53/EU.

The full text of the EU declaration of conformity is available at the following internet address (refer product specific pages): <http://www.microchip.com/design-centers/wireless-connectivity/>.

7. Document Revision History

Revision	Date	Section	Description
A	07/2019	Document	Initial Revision

The Microchip Website

Microchip provides online support via our website at <http://www.microchip.com/>. This website is used to make files and information easily available to customers. Some of the content available includes:

- **Product Support** – Data sheets and errata, application notes and sample programs, design resources, user's guides and hardware support documents, latest software releases and archived software
- **General Technical Support** – Frequently Asked Questions (FAQs), technical support requests, online discussion groups, Microchip design partner program member listing
- **Business of Microchip** – Product selector and ordering guides, latest Microchip press releases, listing of seminars and events, listings of Microchip sales offices, distributors and factory representatives

Product Change Notification Service

Microchip's product change notification service helps keep customers current on Microchip products. Subscribers will receive email notification whenever there are changes, updates, revisions or errata related to a specified product family or development tool of interest.

To register, go to <http://www.microchip.com/pcn> and follow the registration instructions.

Customer Support

Users of Microchip products can receive assistance through several channels:

- Distributor or Representative
- Local Sales Office
- Embedded Solutions Engineer (ESE)
- Technical Support

Customers should contact their distributor, representative or ESE for support. Local sales offices are also available to help customers. A listing of sales offices and locations is included in this document.

Technical support is available through the web site at: <http://www.microchip.com/support>

Microchip Devices Code Protection Feature

Note the following details of the code protection feature on Microchip devices:

- Microchip products meet the specification contained in their particular Microchip Data Sheet.
- Microchip believes that its family of products is one of the most secure families of its kind on the market today, when used in the intended manner and under normal conditions.
- There are dishonest and possibly illegal methods used to breach the code protection feature. All of these methods, to our knowledge, require using the Microchip products in a manner outside the operating specifications contained in Microchip's Data Sheets. Most likely, the person doing so is engaged in theft of intellectual property.
- Microchip is willing to work with the customer who is concerned about the integrity of their code.
- Neither Microchip nor any other semiconductor manufacturer can guarantee the security of their code. Code protection does not mean that we are guaranteeing the product as "unbreakable."

Code protection is constantly evolving. We at Microchip are committed to continuously improving the code protection features of our products. Attempts to break Microchip's code protection feature may be a violation of the Digital Millennium Copyright Act. If such acts allow unauthorized access to your software or other copyrighted work, you may have a right to sue for relief under that Act.

Legal Notice

Information contained in this publication regarding device applications and the like is provided only for your convenience and may be superseded by updates. It is your responsibility to ensure that your application meets with

your specifications. MICROCHIP MAKES NO REPRESENTATIONS OR WARRANTIES OF ANY KIND WHETHER EXPRESS OR IMPLIED, WRITTEN OR ORAL, STATUTORY OR OTHERWISE, RELATED TO THE INFORMATION, INCLUDING BUT NOT LIMITED TO ITS CONDITION, QUALITY, PERFORMANCE, MERCHANTABILITY OR FITNESS FOR PURPOSE. Microchip disclaims all liability arising from this information and its use. Use of Microchip devices in life support and/or safety applications is entirely at the buyer's risk, and the buyer agrees to defend, indemnify and hold harmless Microchip from any and all damages, claims, suits, or expenses resulting from such use. No licenses are conveyed, implicitly or otherwise, under any Microchip intellectual property rights unless otherwise stated.

Trademarks

The Microchip name and logo, the Microchip logo, Adaptec, AnyRate, AVR, AVR logo, AVR Freaks, BesTime, BitCloud, chipKIT, chipKIT logo, CryptoMemory, CryptoRF, dsPIC, FlashFlex, flexPWR, HELDO, IGLOO, JukeBlox, KeeLoq, Kleer, LANCheck, LinkMD, maXStylus, maXTouch, MediaLB, megaAVR, Microsemi, Microsemi logo, MOST, MOST logo, MPLAB, OptoLyzer, PackeTime, PIC, picoPower, PICSTART, PIC32 logo, PolarFire, Prochip Designer, QTouch, SAM-BA, SenGenuity, SpyNIC, SST, SST Logo, SuperFlash, Symmetricom, SyncServer, Tachyon, TempTrackr, TimeSource, tinyAVR, UNI/O, Vectron, and XMEGA are registered trademarks of Microchip Technology Incorporated in the U.S.A. and other countries.

APT, ClockWorks, The Embedded Control Solutions Company, EtherSynch, FlashTec, Hyper Speed Control, HyperLight Load, IntelliMOS, Libero, motorBench, mTouch, Powermite 3, Precision Edge, ProASIC, ProASIC Plus, ProASIC Plus logo, Quiet-Wire, SmartFusion, SyncWorld, Temux, TimeCesium, TimeHub, TimePictra, TimeProvider, Vite, WinPath, and ZL are registered trademarks of Microchip Technology Incorporated in the U.S.A.

Adjacent Key Suppression, AKS, Analog-for-the-Digital Age, Any Capacitor, AnyIn, AnyOut, BlueSky, BodyCom, CodeGuard, CryptoAuthentication, CryptoAutomotive, CryptoCompanion, CryptoController, dsPICDEM, dsPICDEM.net, Dynamic Average Matching, DAM, ECAN, EtherGREEN, In-Circuit Serial Programming, ICSP, INICnet, Inter-Chip Connectivity, JitterBlocker, KleerNet, KleerNet logo, memBrain, Mindi, MiWi, MPASM, MPF, MPLAB Certified logo, MPLIB, MPLINK, MultiTRAK, NetDetach, Omniscient Code Generation, PICDEM, PICDEM.net, PICkit, PICtail, PowerSmart, PureSilicon, QMatrix, REAL ICE, Ripple Blocker, SAM-ICE, Serial Quad I/O, SMART-I.S., SQI, SuperSwitcher, SuperSwitcher II, Total Endurance, TSHARC, USBCheck, VariSense, ViewSpan, WiperLock, Wireless DNA, and ZENA are trademarks of Microchip Technology Incorporated in the U.S.A. and other countries.

SQTP is a service mark of Microchip Technology Incorporated in the U.S.A.

The Adaptec logo, Frequency on Demand, Silicon Storage Technology, and Symmcom are registered trademarks of Microchip Technology Inc. in other countries.

GestIC is a registered trademark of Microchip Technology Germany II GmbH & Co. KG, a subsidiary of Microchip Technology Inc., in other countries.

All other trademarks mentioned herein are property of their respective companies.

© 2019, Microchip Technology Incorporated, Printed in the U.S.A., All Rights Reserved.

ISBN: 978-1-5224-4789-4

Quality Management System

For information regarding Microchip's Quality Management Systems, please visit <http://www.microchip.com/quality>.

Worldwide Sales and Service

AMERICAS	ASIA/PACIFIC	ASIA/PACIFIC	EUROPE
<p>Corporate Office 2355 West Chandler Blvd. Chandler, AZ 85224-6199 Tel: 480-792-7200 Tel: 480-792-7277 Technical Support: http://www.microchip.com/support Web Address: http://www.microchip.com</p> <p>Atlanta Duluth, GA Tel: 678-957-9614 Fax: 678-957-1455</p> <p>Austin, TX Tel: 512-257-3370</p> <p>Boston Westborough, MA Tel: 774-760-0087 Fax: 774-760-0088</p> <p>Chicago Itasca, IL Tel: 630-285-0071 Fax: 630-285-0075</p> <p>Dallas Addison, TX Tel: 972-818-7423 Fax: 972-818-2924</p> <p>Detroit Novi, MI Tel: 248-848-4000</p> <p>Houston, TX Tel: 281-894-5983</p> <p>Indianapolis Noblesville, IN Tel: 317-773-8323 Fax: 317-773-5453 Tel: 317-536-2380</p> <p>Los Angeles Mission Viejo, CA Tel: 949-462-9523 Fax: 949-462-9608 Tel: 951-273-7800</p> <p>Raleigh, NC Tel: 919-844-7510</p> <p>New York, NY Tel: 631-435-6000</p> <p>San Jose, CA Tel: 408-735-9110 Tel: 408-436-4270</p> <p>Canada - Toronto Tel: 905-695-1980 Fax: 905-695-2078</p>	<p>Australia - Sydney Tel: 61-2-9868-6733</p> <p>China - Beijing Tel: 86-10-8569-7000</p> <p>China - Chengdu Tel: 86-28-8665-5511</p> <p>China - Chongqing Tel: 86-23-8980-9588</p> <p>China - Dongguan Tel: 86-769-8702-9880</p> <p>China - Guangzhou Tel: 86-20-8755-8029</p> <p>China - Hangzhou Tel: 86-571-8792-8115</p> <p>China - Hong Kong SAR Tel: 852-2943-5100</p> <p>China - Nanjing Tel: 86-25-8473-2460</p> <p>China - Qingdao Tel: 86-532-8502-7355</p> <p>China - Shanghai Tel: 86-21-3326-8000</p> <p>China - Shenyang Tel: 86-24-2334-2829</p> <p>China - Shenzhen Tel: 86-755-8864-2200</p> <p>China - Suzhou Tel: 86-186-6233-1526</p> <p>China - Wuhan Tel: 86-27-5980-5300</p> <p>China - Xian Tel: 86-29-8833-7252</p> <p>China - Xiamen Tel: 86-592-2388138</p> <p>China - Zhuhai Tel: 86-756-3210040</p>	<p>India - Bangalore Tel: 91-80-3090-4444</p> <p>India - New Delhi Tel: 91-11-4160-8631</p> <p>India - Pune Tel: 91-20-4121-0141</p> <p>Japan - Osaka Tel: 81-6-6152-7160</p> <p>Japan - Tokyo Tel: 81-3-6880-3770</p> <p>Korea - Daegu Tel: 82-53-744-4301</p> <p>Korea - Seoul Tel: 82-2-554-7200</p> <p>Malaysia - Kuala Lumpur Tel: 60-3-7651-7906</p> <p>Malaysia - Penang Tel: 60-4-227-8870</p> <p>Philippines - Manila Tel: 63-2-634-9065</p> <p>Singapore Tel: 65-6334-8870</p> <p>Taiwan - Hsin Chu Tel: 886-3-577-8366</p> <p>Taiwan - Kaohsiung Tel: 886-7-213-7830</p> <p>Taiwan - Taipei Tel: 886-2-2508-8600</p> <p>Thailand - Bangkok Tel: 66-2-694-1351</p> <p>Vietnam - Ho Chi Minh Tel: 84-28-5448-2100</p>	<p>Austria - Wels Tel: 43-7242-2244-39 Fax: 43-7242-2244-393</p> <p>Denmark - Copenhagen Tel: 45-4450-2828 Fax: 45-4485-2829</p> <p>Finland - Espoo Tel: 358-9-4520-820</p> <p>France - Paris Tel: 33-1-69-53-63-20 Fax: 33-1-69-30-90-79</p> <p>Germany - Garching Tel: 49-8931-9700</p> <p>Germany - Haan Tel: 49-2129-3766400</p> <p>Germany - Heilbronn Tel: 49-7131-72400</p> <p>Germany - Karlsruhe Tel: 49-721-625370</p> <p>Germany - Munich Tel: 49-89-627-144-0 Fax: 49-89-627-144-44</p> <p>Germany - Rosenheim Tel: 49-8031-354-560</p> <p>Israel - Ra'anana Tel: 972-9-744-7705</p> <p>Italy - Milan Tel: 39-0331-742611 Fax: 39-0331-466781</p> <p>Italy - Padova Tel: 39-049-7625286</p> <p>Netherlands - Druenen Tel: 31-416-690399 Fax: 31-416-690340</p> <p>Norway - Trondheim Tel: 47-72884388</p> <p>Poland - Warsaw Tel: 48-22-3325737</p> <p>Romania - Bucharest Tel: 40-21-407-87-50</p> <p>Spain - Madrid Tel: 34-91-708-08-90 Fax: 34-91-708-08-91</p> <p>Sweden - Gothenberg Tel: 46-31-704-60-40</p> <p>Sweden - Stockholm Tel: 46-8-5090-4654</p> <p>UK - Wokingham Tel: 44-118-921-5800 Fax: 44-118-921-5820</p>