



Product Change Notification - SYST-30VFMD228

Date:

31 May 2019

Product Category:

Switching Regulators

Affected CPNs:



Notification subject:

Data Sheet - MIC2205 - 2MHz PWM Synchronous Buck Regulator with LDO Standby Mode

Notification text:

SYST-30VFMD228

Microchip has released a new DeviceDoc for the MIC2205 - 2MHz PWM Synchronous Buck Regulator with LDO Standby Mode of devices. If you are using one of these devices please read the document located at [MIC2205 - 2MHz PWM Synchronous Buck Regulator with LDO Standby Mode](#).

Data Sheet - MIC2205 - 2MHz PWM Synchronous Buck Regulator with LDO Standby Mode

Notification Status: Final

Description of Change:

- 1) Converted Micrel document MIC2205 to Microchip data sheet DS20006177A.
- 2) Minor text changes throughout.

Impacts to Data Sheet: None

Reason for Change: To Improve Manufacturability

Change Implementation Status: Complete

Date Document Changes Effective: 31 May 2019

NOTE: Please be advised that this is a change to the document only the product has not been changed.

Markings to Distinguish Revised from Unrevised Devices: N/A

Attachment(s):

[MIC2205 - 2MHz PWM Synchronous Buck Regulator with LDO Standby Mode](#)

Please contact your local [Microchip sales office](#) with questions or concerns regarding this notification.

Terms and Conditions:

If you wish to receive Microchip PCNs via email please register for our PCN email service at our [PCN home page](#) select register then fill in the required fields. You will find instructions about registering for Microchips PCN email service in the [PCN FAQ](#) section.

If you wish to change your PCN profile, including opt out, please go to the [PCN home page](#) select login and sign into your myMicrochip account. Select a profile option from the left navigation bar and make the applicable selections.

Affected Catalog Part Numbers (CPN)

MIC2205-1.38YML-TR

MIC2205-1.3YML-TR

MIC2205-1.58YML-TR

MIC2205-1.5YML-TR

MIC2205-1.85YML-TR

MIC2205-1.8YML-TR

MIC2205YML-EV

MIC2205YML-TR

2 MHz PWM Synchronous Buck Regulator with LDO Standby Mode

Feature

- 2.7 to 5.5V Supply Voltage
- Light Load LDO Mode
 - 18 μ A Quiescent Current
 - Low Noise, 75 μ V_{RMS}
- 2 MHz PWM Mode
 - Output Current to 600 mA
 - >95% Efficiency
 - 100% Maximum Duty Cycle
- Adjustable Output Voltage Option Down to 1V
 - Fixed Output Voltage Options Available
- Ultra-Fast Transient Response
- Stable with 1 μ F Ceramic Output Capacitor
- Fully Integrated MOSFET Switches
- Micropower Shutdown
- Thermal Shutdown and Current Limit Protection
- Pb-Free 3 mm x 3 mm VDFN Package
- -40°C to +125°C Junction Temperature Range

Applications

- Cellular Phones
- PDAs
- USB Peripherals

General Description

The MIC2205 is a high efficiency 2 MHz PWM synchronous buck (step-down) regulator that features an LDO standby mode that draws only 18 μ A of quiescent current. The MIC2205 allows an ultra-low noise, small size, and high efficiency solution for portable power applications.

In PWM mode, the MIC2205 operates with a constant frequency 2 MHz PWM control. Under light load conditions, such as in system sleep or standby modes, the PWM switching operation can be disabled to reduce switching losses. In this light load mode, the LDO maintains the output voltage and draws only 18 μ A of quiescent current. The LDO mode of operation saves battery life while not introducing spurious noise and high ripple as experienced with pulse skipping or bursting mode regulators.

The MIC2205 operates from 2.7V to 5.5V input and features internal power MOSFETs that can supply up to 600 mA output current in PWM mode. It can operate with a maximum duty cycle of 100% for use in low dropout conditions.

The MIC2205 is available in a 3 mm x 3 mm VDFN-10L package with an operating junction temperature range from -40°C to +125°C.

Package Type

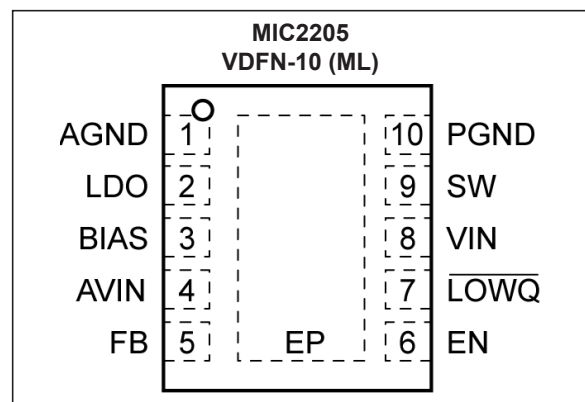

1.0 ELECTRICAL CHARACTERISTICS

Absolute Maximum Ratings †

| | |
|--|-------------------|
| Supply Voltage (V_{IN}) | +6V |
| Output Switch Voltage (V_{SW}) | +6V |
| Output Switch Current (I_{SW}) | 2A |
| Logic Input Voltage (V_{EN}, V_{LOWQ}) | -0.3V to V_{IN} |
| Storage Temperature (T_S) | -60°C to +150°C |
| ESD Rating (Note 1) | 3 kV |

Operating Ratings ‡

| | |
|---|-------------------|
| Supply Voltage (V_{IN}) | +2.7V to +5.5V |
| Logic Input Voltage (V_{EN}, V_{LOWQ}) | -0.3V to V_{IN} |
| Junction Temperature (T_J) | -40°C to +125°C |
| Package Thermal Resistance VDFN-10 (θ_{JA}) | 60°C/W |

† **Notice:** Stresses above those listed under “Absolute Maximum Ratings” may cause permanent damage to the device. This is a stress rating only and functional operation of the device at those or any other conditions above those indicated in the operational sections of this specification is not intended. Exposure to maximum rating conditions for extended periods may affect device reliability. Specifications are for packaged product only.

‡ **Notice:** The device is not guaranteed to function outside its operating ratings.

Note 1: Devices are ESD sensitive. Handling precautions recommended. Human body model: 1.5 k Ω in series with 100 pF.

ELECTRICAL CHARACTERISTICS (Note 2)

Electrical Characteristics: $V_{IN} = V_{EN} = V_{LOWQ} = 3.6V$; $L = 2.2 \mu H$; $T_A = 25^\circ C$, **Bold** values indicate $-40^\circ C \leq T_A \leq +125^\circ C$; unless otherwise noted.

| Parameter | Symbol | Min. | Typ. | Max. | Units | Conditions |
|--|--------|---------------------|------|---------------------|---------|--|
| Supply Voltage Range | — | 2.7 | — | 5.5 | V | — |
| Undervoltage Lockout Threshold | — | 2.45 | 2.55 | 2.65 | V | Turn-On |
| UVLO Hysteresis | — | — | 100 | — | mV | — |
| Quiescent Current, PWM mode | — | — | 690 | 900 | μA | $V_{FB} = 0.9 * V_{NOM}$ (not switching) |
| Quiescent Current, LDO mode | — | — | 16 | 29 | μA | $V_{LOWQ} = 0V$; $I_{OUT} = 0 mA$ |
| Shutdown Current | — | — | 0.01 | 5 | μA | $V_{EN} = 0V$ |
| [Adjustable] Feedback Voltage | — | 0.99 0.98 | 1 | 1.01 1.02 | V | $\pm 1\%$ $\pm 2\%$ (over temperature) |
| [Fixed Output] Voltages | — | -1 -2 | — | +1 +2 | % | Nominal V_{OUT} tolerance |
| FB pin input current | — | — | 1 | — | nA | — |
| Current Limit in PWM Mode | — | 0.75 | 1 | 1.85 | A | $V_{FB} = 0.9 * V_{NOM}$ |
| Output Voltage Line Regulation | — | — | 0.13 | — | % | $V_{OUT} > 2V$; $V_{IN} = V_{OUT} + 300 mV$ to 5.5V; $I_{LOAD} = 100 mA$ $V_{OUT} < 2V$; $V_{IN} = 2.7V$ to 5.5V; $I_{LOAD} = 100 mA$ |
| Output Voltage Load Regulation, PWM Mode | — | — | 0.2 | 0.5 | % | $20 mA < I_{LOAD} < 300 mA$ |
| Output Voltage Load Regulation, LDO Mode | — | — | 0.1 | 0.2 | % | $100 \mu A < I_{LOAD} < 50 mA$ $V_{LOWQ} = 0V$ |
| Maximum Duty Cycle | — | 100 | — | — | % | $V_{FB} \leq 0.4V$ |

MIC2205

ELECTRICAL CHARACTERISTICS (Note 2)

Electrical Characteristics: $V_{IN} = V_{EN} = V_{LOWQ} = 3.6V$; $L = 2.2 \mu H$; $T_A = 25^\circ C$, **Bold** values indicate $-40^\circ C \leq T_A \leq +125^\circ C$; unless otherwise noted.

| Parameter | Symbol | Min. | Typ. | Max. | Units | Conditions |
|------------------------------|--------|------------|------|------------|---------------|--|
| PWM Switch-On Resistance | — | — | 0.4 | — | Ω | $I_{SW} = 50 \text{ mA}$ $V_{FB} = 0.7V_{FB_NOM}$ (High Side Switch) |
| | — | — | 0.4 | — | | $I_{SW} = -50 \text{ mA}$ $V_{FB} = 1.1V_{FB_NOM}$ (Low Side Switch) |
| Oscillator Frequency | — | 1.8 | 2 | 2.2 | MHz | — |
| LOWQ Threshold Voltage | — | 0.5 | 0.85 | 1.3 | V | — |
| LOWQ Input Current | — | — | 0.1 | 2 | μA | — |
| Enable Threshold | — | 0.5 | 0.85 | 1.3 | V | — |
| Enable Input Current | — | — | 0.1 | 2 | μA | — |
| LDO Dropout Voltage (Note 1) | — | — | 110 | — | mV | $I_{OUT} = 50 \text{ mA}$ |
| Output Voltage Noise | — | — | 75 | — | μV_{rms} | $\overline{LOWQ} = 0V$; $C_{OUT} = 2.2 \mu F$, 10 Hz to 100 kHz |
| LDO Current Limit | — | 60 | 120 | — | mA | $\overline{LOWQ} = 0V$; $V_{OUT} = 0V$ (LDO Mode) |
| Overtemperature Shutdown | — | — | 160 | — | $^\circ C$ | — |
| Overtemperature Hysteresis | — | — | 20 | — | $^\circ C$ | — |

Note 1: Dropout voltage is defined as the input-to-output differential at which the output voltage drops 2% below its nominal value that is initially measured at a 1V differential. For outputs below 2.7V, the dropout voltage is the input-to-output voltage differential with a minimum input voltage of 2.7V

2: Specification for packaged product only.

TEMPERATURE SPECIFICATIONS (Note 1)

| Parameters | Symbol | Min. | Typ. | Max. | Units | Conditions |
|------------------------------------|---------------|------|------|------|-------|------------|
| Temperature Ranges | | | | | | |
| Storage Temperature | T_S | -60 | — | +150 | °C | — |
| Junction Temperature Range | T_J | -40 | — | +125 | °C | — |
| Package Thermal Resistances | | | | | | |
| Thermal Resistance 10-Lead VDFN | θ_{JA} | — | — | 60 | °C/W | — |

Note 1: The maximum allowable power dissipation is a function of ambient temperature, the maximum allowable junction temperature and the thermal resistance from junction to air (i.e., T_A , T_J , θ_{JA}). Exceeding the maximum allowable power dissipation will cause the device operating junction temperature to exceed the maximum +125°C rating. Sustained junction temperatures above +125°C can impact the device reliability.

MIC2205

2.0 TYPICAL PERFORMANCE CURVES

Note: The graphs and tables provided following this note are a statistical summary based on a limited number of samples and are provided for informational purposes only. The performance characteristics listed herein are not tested or guaranteed. In some graphs or tables, the data presented may be outside the specified operating range (e.g., outside specified power supply range) and therefore outside the warranted range.

PWM Mode

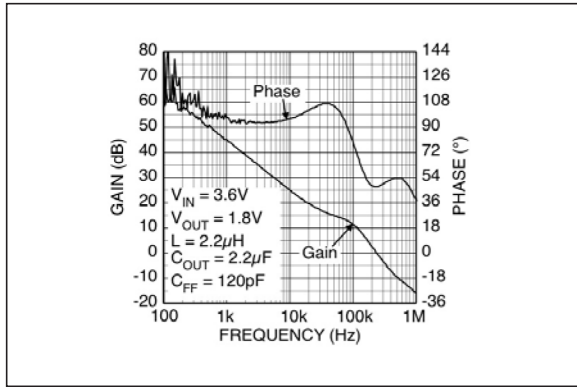

FIGURE 2-1: Bode Plot.

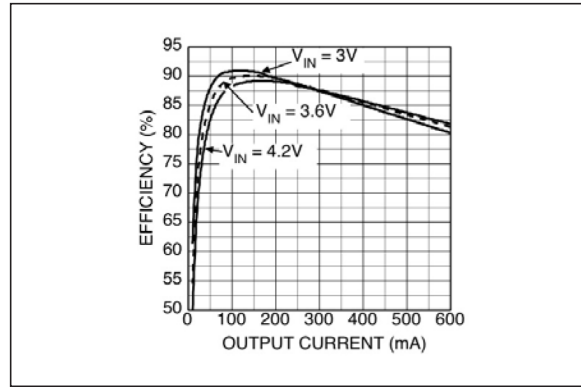

FIGURE 2-4: $1.5 V_{OUT}$ Efficiency.

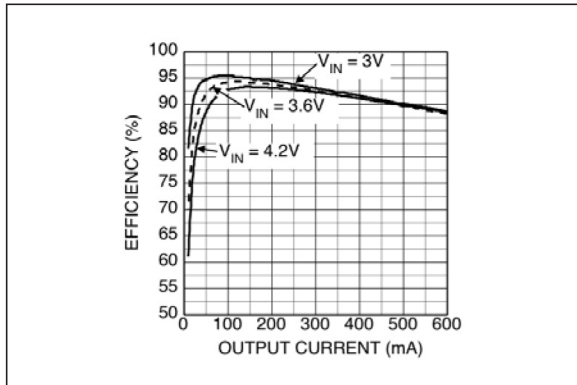

FIGURE 2-2: $2.5 V_{OUT}$ Efficiency.

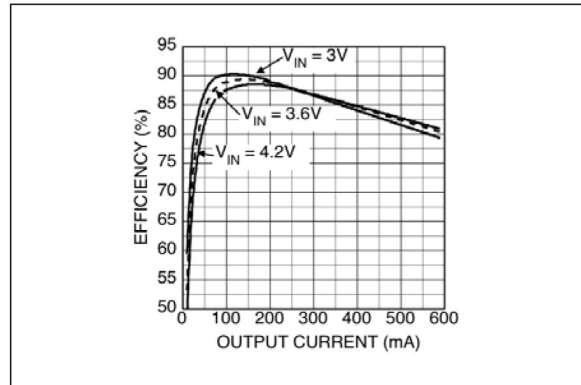

FIGURE 2-5: $1.38 V_{OUT}$ Efficiency.

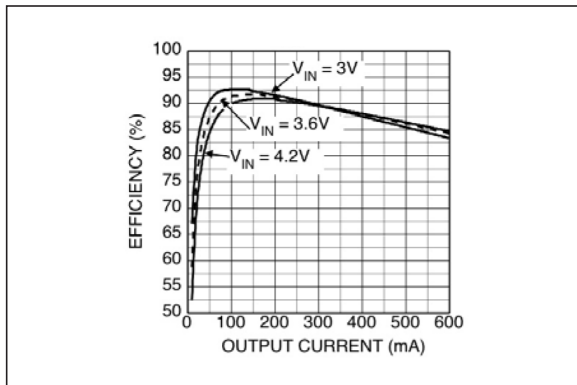

FIGURE 2-3: $1.8 V_{OUT}$ Efficiency.

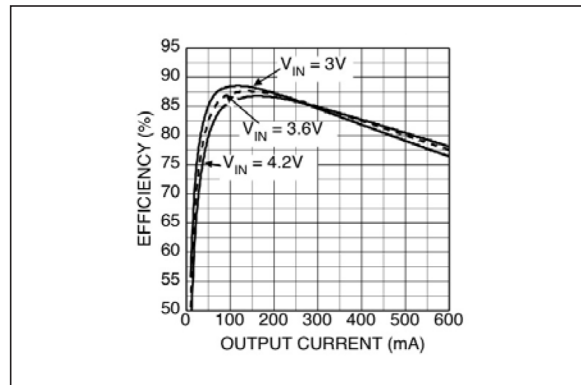

FIGURE 2-6: $1.2 V_{OUT}$ Efficiency.

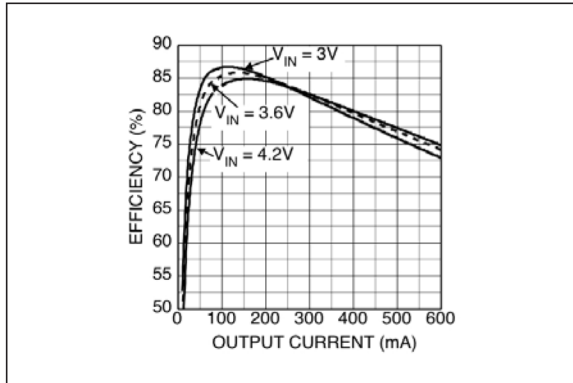

FIGURE 2-7: 1.0 V_{OUT} Efficiency.

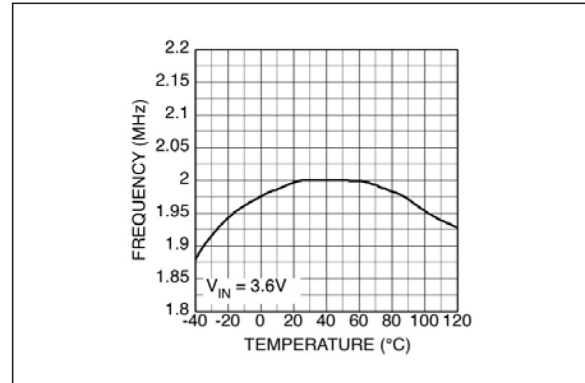

FIGURE 2-10: Frequency vs. Temperature.

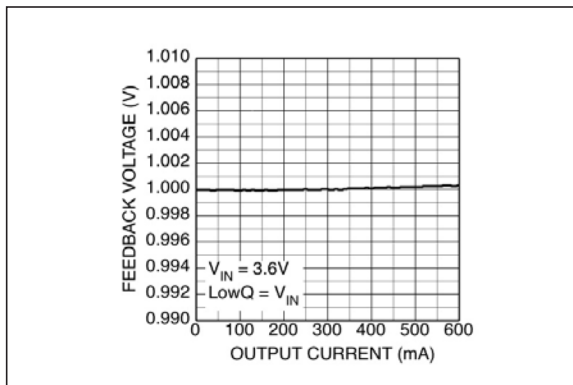

FIGURE 2-8: Load Regulation.

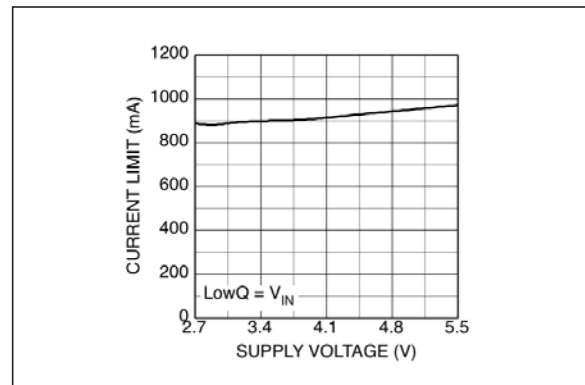

FIGURE 2-11: Peak Current Limit vs. Voltage.

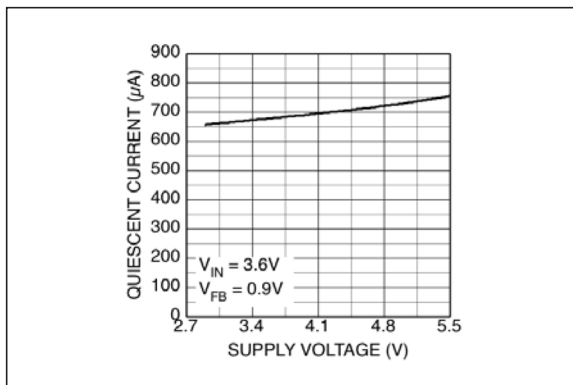

FIGURE 2-9: Quiescent Current vs. Supply Voltage.

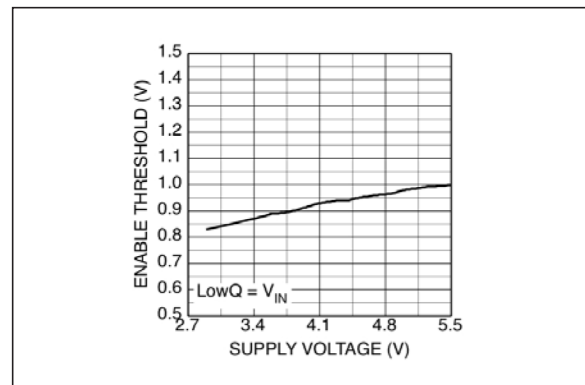

FIGURE 2-12: Enable Threshold vs. Voltage.

MIC2205

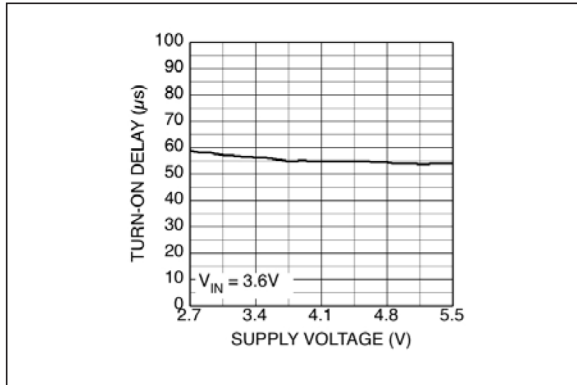

FIGURE 2-13: Turn-On Time vs. Supply Voltage.

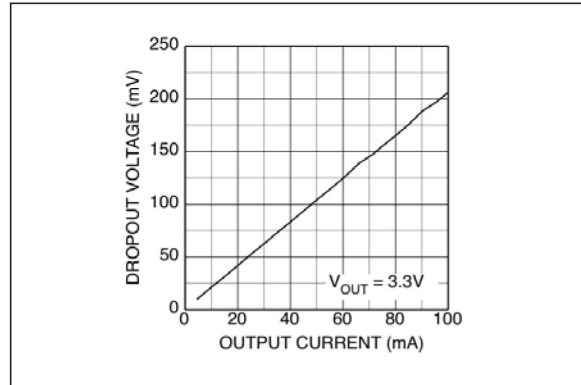

FIGURE 2-16: Dropout vs. Output Current.

LDO Mode

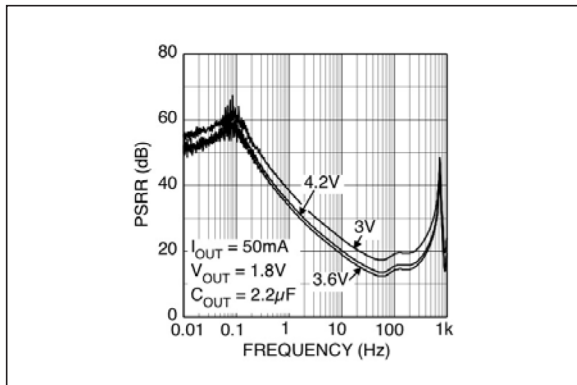

FIGURE 2-14: PSRR.

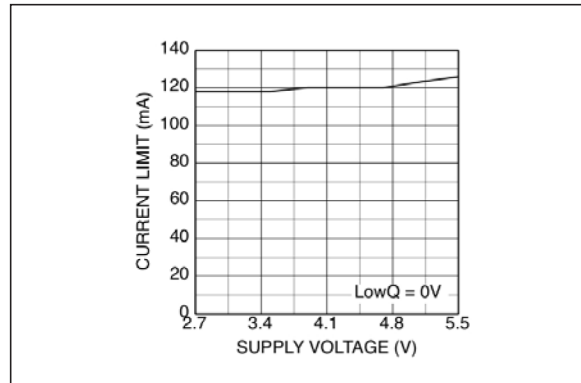

FIGURE 2-17: Current Limit vs. Supply Voltage.

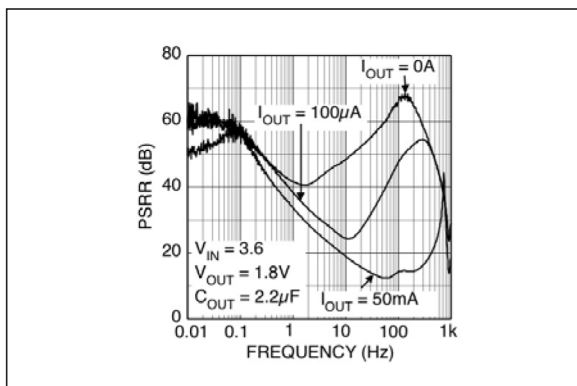

FIGURE 2-15: PSRR.

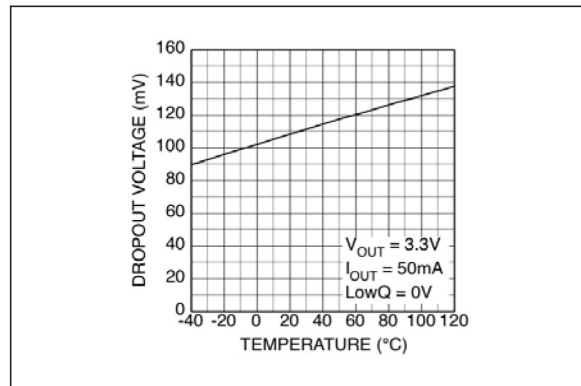

FIGURE 2-18: Dropout Voltage vs. Temperature.

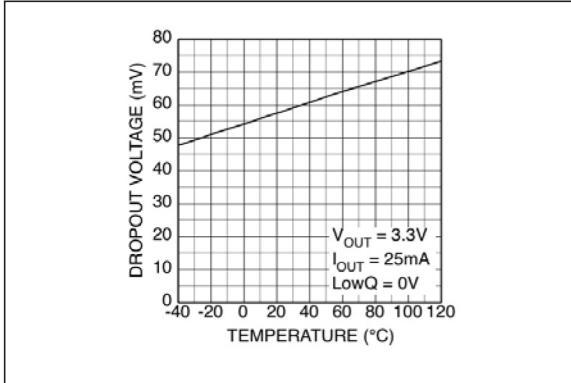

FIGURE 2-19: Dropout Voltage vs. Temperature.

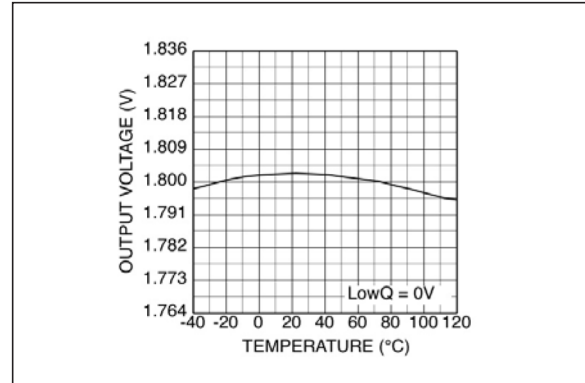

FIGURE 2-22: Output Voltage vs. Temperature.

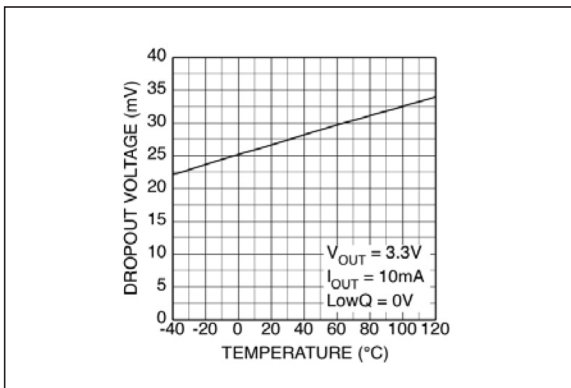

FIGURE 2-20: Dropout Voltage vs. Temperature.

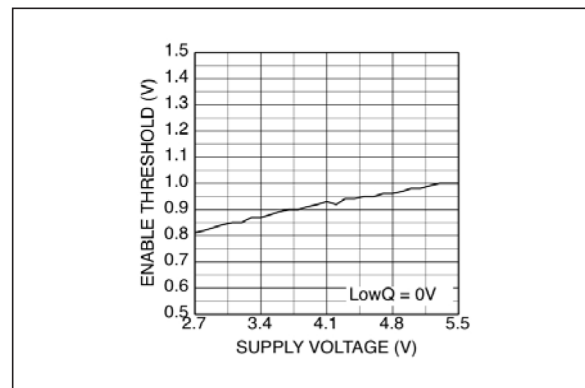

FIGURE 2-23: Enable Threshold Voltage vs. Supply Voltage.

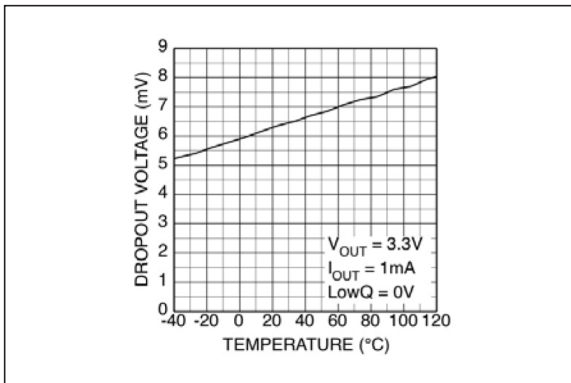

FIGURE 2-21: Dropout Voltage vs. Temperature.

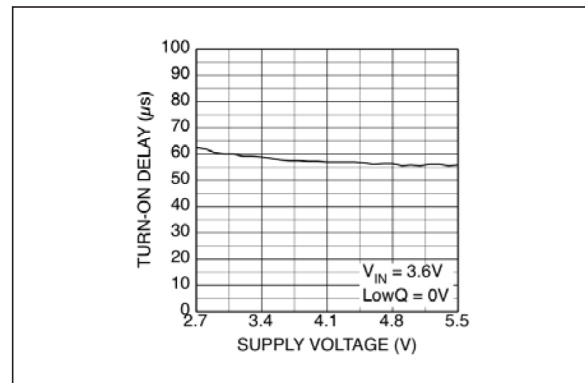

FIGURE 2-24: Turn-On Time vs. Supply Voltage.

MIC2205

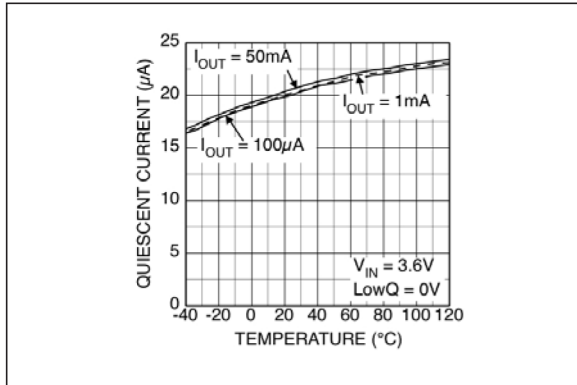

FIGURE 2-25: Quiescent Current vs. Temperature.

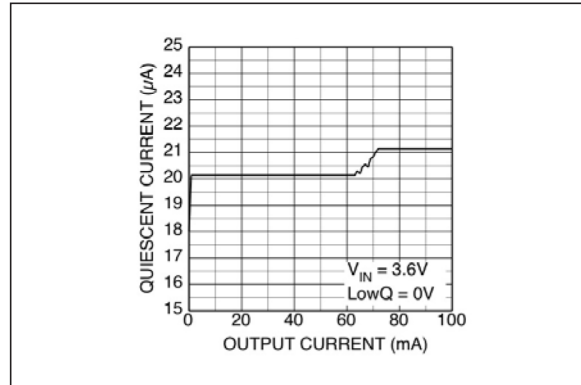

FIGURE 2-28: Quiescent Current vs. Output Current.

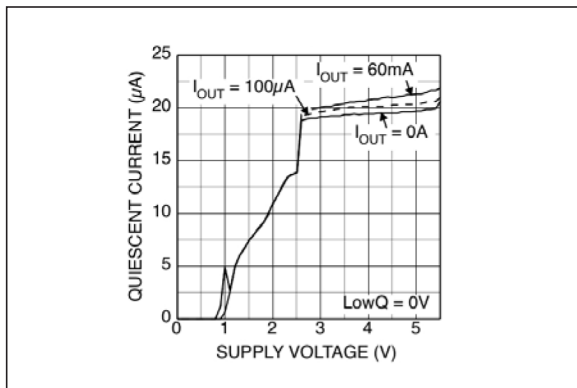

FIGURE 2-26: Quiescent Current vs. Temperature.

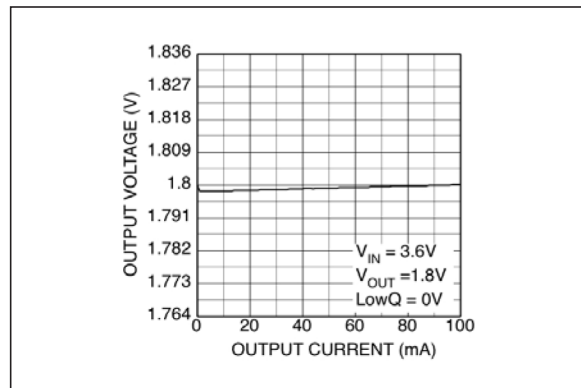

FIGURE 2-29: Output Voltage vs. Output Current.

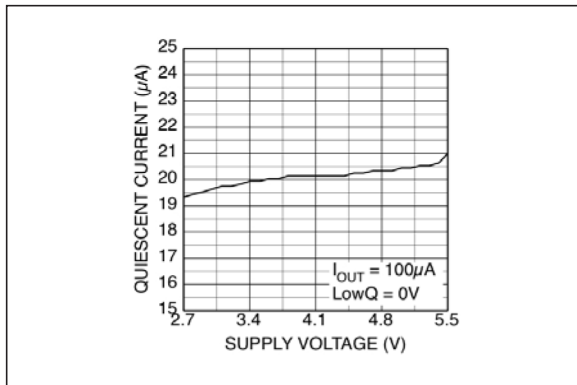

FIGURE 2-27: Quiescent Current vs. Supply Voltage.

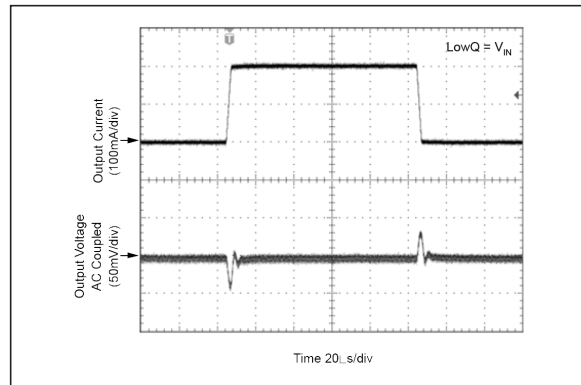

FIGURE 2-30: Load Transient PWM Mode.

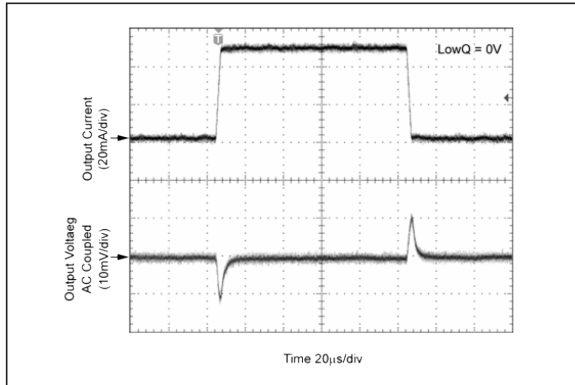

FIGURE 2-31: Load Transient LDO Mode.

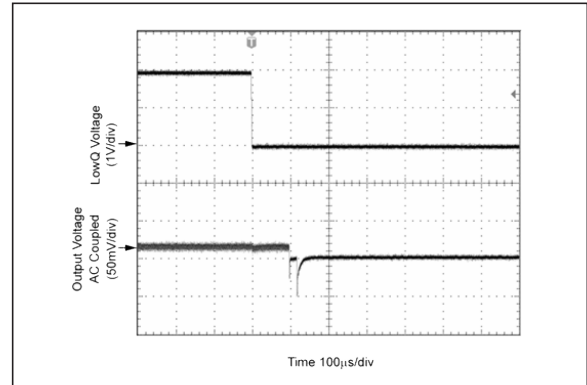

FIGURE 2-34: PWM Mode to LDO Mode Transient.

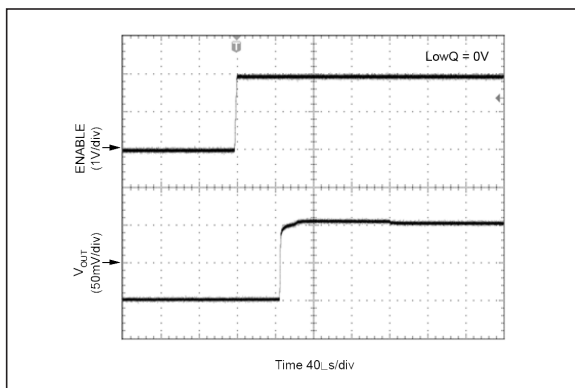

FIGURE 2-32: Enable Transient PWM Mode.

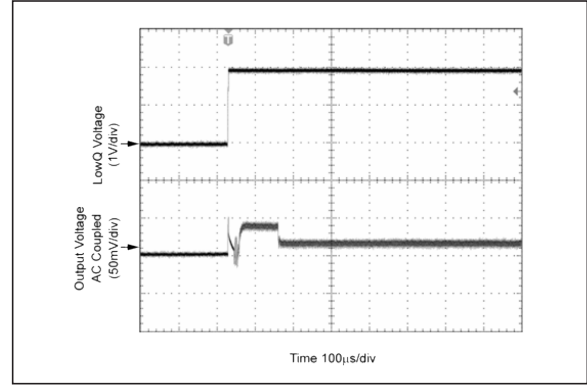

FIGURE 2-35: LDO Mode to PWM Mode Transient.

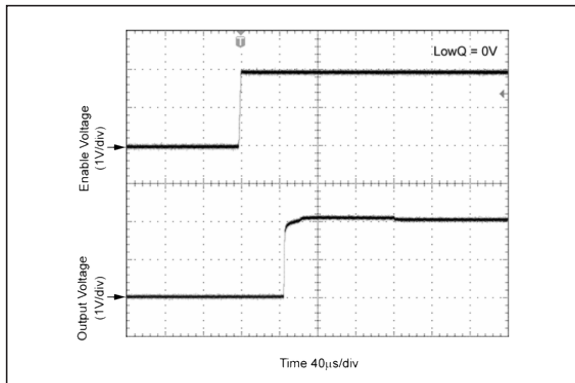

FIGURE 2-33: Enable Transient LDO Mode.

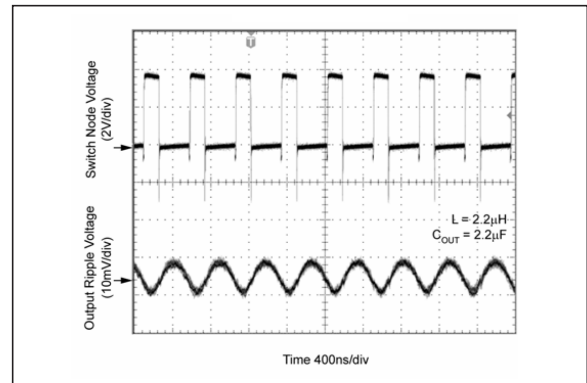

FIGURE 2-36: PWM Waveform.

MIC2205

3.0 PIN DESCRIPTIONS

The descriptions of the pins are listed in [Table 3-1](#).

TABLE 3-1: PIN FUNCTION TABLE

| Pin Number | Pin Name | Description |
|------------|-------------------|---|
| 1 | AGND | Analog (Signal) Ground. |
| 2 | LDO | LDO (Output): Connect to V_{OUT} for LDO mode operation. |
| 3 | BIAS | Internal circuit bias supply. Must be de-coupled to signal ground with a 0.1 μ F capacitor and should not be loaded. |
| 4 | AVIN | Analog Supply Voltage (Input): Supply voltage for the analog control circuitry and LDO input power. Requires bypass capacitor to GND. |
| 5 | FB | Feedback. Input to the error amplifier. For the adjustable option, connect to the external resistor divider network to set the output voltage. For fixed output voltage options, connect the feed forward capacitor between this pin and V_{OUT} ; the internal resistor network sets the output voltage. |
| 6 | EN | Enable (Input). Logic low will shut down the device, reducing the quiescent current to less than 5 μ A. |
| 7 | \overline{LOWQ} | Enable LDO Mode (Input): Logic low enables the internal LDO and disables the PWM operation. Logic high enables the PWM mode and disables the LDO mode. |
| 8 | VIN | Supply Voltage (Input): Supply voltage for the internal switches and drivers. |
| 9 | SW | Switch (Output): Internal power MOSFET output switches. |
| 10 | PGND | Power Ground. |
| EP | GND | Ground, backside pad. |

4.0 FUNCTIONAL DESCRIPTION

4.1 VIN

VIN provides power to the MOSFETs for the switch mode regulator section, along with the current limiting sensing. Due to the high switching speeds, a 1 μF capacitor is recommended close to VIN and the power ground (PGND) pin for bypassing.

4.2 AVIN

Analog VIN (AVIN) provides power to the LDO section and the bias through an internal 6Ω resistor. AVIN and VIN must be tied together. Careful layout should be considered to ensure high frequency switching noise caused by VIN is reduced before reaching AVIN.

4.3 LDO

The LDO pin is the output of the linear regulator and should be connected to the output. In LOWQ mode ($\overline{\text{LOWQ}} < 1.5\text{V}$), the LDO provides the output voltage. In PWM mode ($\overline{\text{LOWQ}} > 1.5\text{V}$) the LDO pin is high impedance.

4.4 EN

The enable pin provides a logic level control of the output. In the off state, supply current of the device is greatly reduced (typically <1 μA). Also, in the off state, the output drive is placed in a tri-stated condition, where both the high side P-channel MOSFET and the low-side N-channel are in an off or non-conducting state. Do not drive the enable pin above the supply voltage.

4.5 $\overline{\text{LOWQ}}$

The $\overline{\text{LOWQ}}$ pin provides a logic level control between the internal PWM mode and the low noise linear regulator mode. With $\overline{\text{LOWQ}}$ pulled low (<0.5V), quiescent current of the device is greatly reduced by switching to a low noise linear regulator mode that has a typical I_Q of 18 μA. In linear (LDO) mode the output can deliver 60 mA of current to the output. By placing $\overline{\text{LOWQ}}$ high (>1.5V), this transitions the device into a constant frequency PWM buck regulator mode. This allows the device the ability to efficiently deliver up to 600 mA of output current at the same output voltage.

4.6 BIAS

The BIAS pin supplies the power to the internal power to the control and reference circuitry. The bias is powered from AVIN through an internal 6Ω resistor. A small 0.1 μF capacitor is recommended for bypassing.

4.7 FB

The feedback pin (FB) provides the control path to control the output. For adjustable versions, a resistor divider connecting the feedback to the output is used to adjust the desired output voltage. The output voltage is calculated as shown in Equation 4-1.

EQUATION 4-1:

$$V_{OUT} = V_{REF} \times \left(\frac{R1}{R2} + 1 \right)$$

Where:

$$V_{REF} = 1.0\text{V}$$

A feed-forward capacitor is recommended for most designs using the adjustable output voltage option. To reduce battery current draw, a 100 kΩ feedback resistor is recommended from the output to the FB pin (R1). Also, a feed-forward capacitor should be connected between the output and feedback (across R1). The large resistor value and the parasitic capacitance of the FB pin can cause a high frequency pole that can reduce the overall system phase margin. By placing a feed-forward capacitor, these effects can be significantly reduced. Feed-forward capacitance (C_{FF}) can be calculated as shown in Equation 4-2.

EQUATION 4-2:

$$C_{FF} = \frac{1}{2\pi \times R1 \times 160\text{kHz}}$$

For fixed options a feed-forward capacitor from the output to the FB pin is required. Typically a 100 pF small ceramic capacitor is recommended.

4.8 SW

The switch (SW) pin connects directly to the inductor and provides the switching current necessary to operate in PWM mode. Due to the high speed switching on this pin, the switch node should be routed away from sensitive nodes and it should be as small as possible.

4.9 PGND

Power ground (PGND) is the ground path for the high current PWM mode. The current loop for the power ground should be as small as possible and separate from the Analog ground (AGND) loop.

4.10 SGND

Signal ground (SGND) is the ground path for the biasing and control circuitry. The current loop for the signal ground should be separate from the Power ground (PGND) loop.

5.0 APPLICATIONS INFORMATION

The MIC2205 is a 600 mA PWM power supply that utilizes a LOWQ light load mode to maximize battery efficiency in light load conditions. This is achieved with a $\overline{\text{LOWQ}}$ control pin that when pulled low, shuts down all the biasing and drive current for the PWM regulator, drawing only 18 μA of operating current. This allows the output to be regulated through the LDO output, capable of providing 60 mA of output current. This method has the advantage of producing a clean, low current, ultra low noise output in LOWQ mode. During LOWQ mode, the SW node becomes high impedance, blocking current flow. Other methods of reducing quiescent current, such as pulse frequency modulation (PFM) or bursting techniques, create large amplitude, low frequency ripple voltages that can be detrimental to system operation.

When more than 60 mA is required, the $\overline{\text{LOWQ}}$ pin can be forced high, causing the MIC2205 to enter PWM mode. In this case, the LDO output makes a hand-off to the PWM regulator with virtually no variation in output voltage. The LDO output then turns off allowing up to 600 mA of current to be efficiently supplied through the PWM output to the load.

5.1 Input Capacitor

A minimum 1 μF ceramic is recommended on the VIN pin for bypassing. X5R or X7R dielectrics are recommended for the input capacitor. Y5V dielectrics lose most of their capacitance over temperature and are therefore, not recommended.

A minimum 1 μF is recommended close to the VIN and PGND pins for high frequency filtering. Smaller case size capacitors are recommended due to their lower ESR and ESL.

5.2 Output Capacitor

Even though the MIC2205 is optimized for a 2.2 μF output capacitor, output capacitance can be varied from 1 μF to 4.7 μF . The MIC2205 utilizes type III internal compensation and utilizes an internal high frequency zero to compensate for the double pole roll off of the LC filter. For this reason, larger output capacitors can create instabilities. X5R or X7R dielectrics are recommended for the output capacitor. Y5V dielectrics lose most of their capacitance over temperature and are therefore, not recommended.

In addition to a 2.2 μF , a small 10 nF is recommended close to the load for high frequency filtering. Smaller case size capacitors are recommended due to their lower ESR and ESL.

5.3 Inductor Selection

The MIC2205 is designed for use with a 2.2 μH inductor. Proper selection should ensure the inductor can handle the maximum average and peak currents required by the load. Maximum current ratings of the inductor are generally given in two methods; permissible DC current and saturation current. Permissible DC current can be rated either for a 40°C temperature rise or a 10% to 20% loss in inductance. Ensure that the inductor selected can handle the maximum operating current. When saturation current is specified, make sure that there is enough margin that the peak current will not saturate the inductor. Peak inductor current can be calculated as shown in Equation 5-1.

EQUATION 5-1:

$$I_{PK} = I_{OUT} + \frac{V_{OUT} \left(1 - \frac{V_{OUT}}{V_{IN}}\right)}{2 \times f \times L}$$

MIC2205

6.0 PACKAGING INFORMATION

6.1 Package Marking Information

10-Lead VDFN*

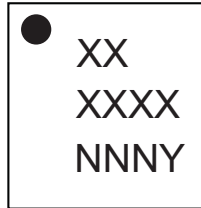

Example

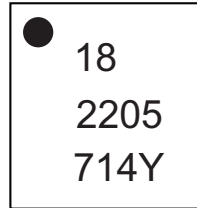

| | | |
|----------------|--|--|
| Legend: | XX...X | Product code or customer-specific information |
| | Y | Year code (last digit of calendar year) |
| | YY | Year code (last 2 digits of calendar year) |
| | WW | Week code (week of January 1 is week '01') |
| | NNN | Alphanumeric traceability code |
| | (e3) | Pb-free JEDEC® designator for Matte Tin (Sn) |
| | * | This package is Pb-free. The Pb-free JEDEC designator ((e3)) can be found on the outer packaging for this package. |
| | ●, ▲, ▼ | Pin one index is identified by a dot, delta up, or delta down (triangle mark). |
| Note: | In the event the full Microchip part number cannot be marked on one line, it will be carried over to the next line, thus limiting the number of available characters for customer-specific information. Package may or may not include the corporate logo. | |
| | Underbar (¯) and/or Overbar (¯) symbol may not be to scale. | |

10-Lead VDFN (ML) Package Outline and Recommended Land Pattern



10-Lead Very Thin Plastic Dual Flat, No Lead Package (JFA) - 3x3x0.9 mm Body [VDFN] Micrel Legacy Package DFN33-10LD-PL-1

Note: For the most current package drawings, please see the Microchip Packaging Specification located at <http://www.microchip.com/packaging>

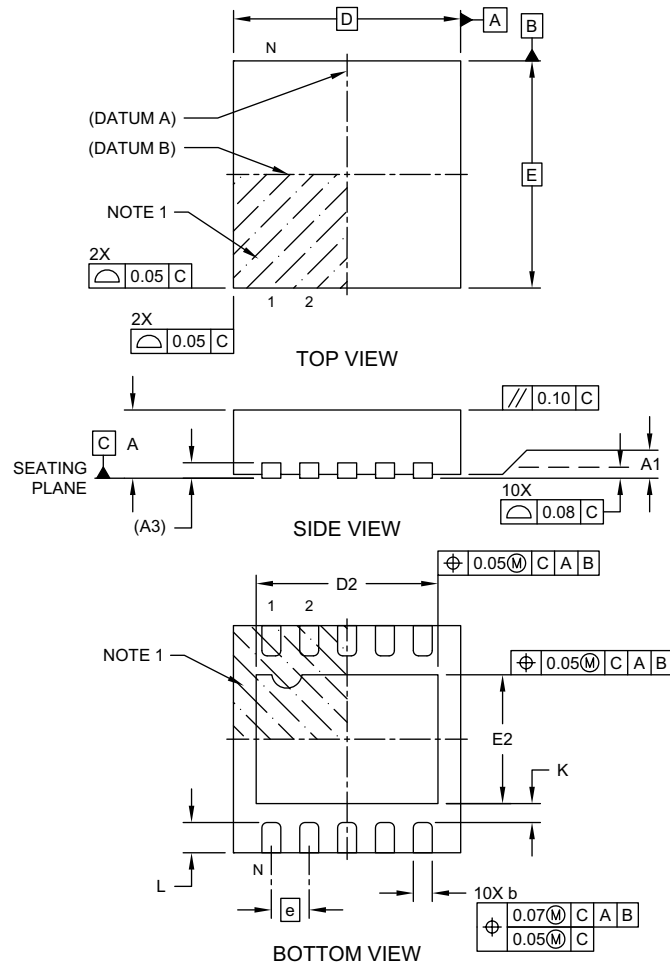

Microchip Technology Drawing C04-1019-JFA Rev A Sheet 1 of 2

© 2019 Microchip Technology Incorporated

MIC2205

10-Lead VDFN (ML) Recommended Land Pattern



10-Lead Very Thin Plastic Dual Flat, No Lead Package (JFA) - 3x3x0.9 mm Body [VDFN] Micrel Legacy Package DFN33-10LD-PL-1

Note: For the most current package drawings, please see the Microchip Packaging Specification located at <http://www.microchip.com/packaging>

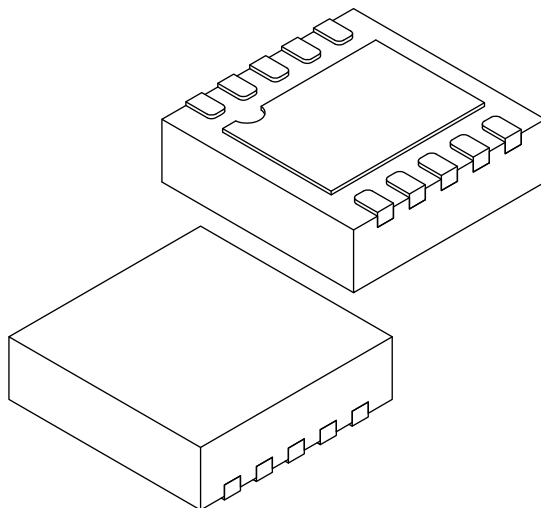

| Dimension Limits | Units | MILLIMETERS | | |
|-------------------------|-------|-------------|------|------|
| | | MIN | NOM | MAX |
| Number of Terminals | N | 10 | | |
| Pitch | e | 0.50 BSC | | |
| Overall Height | A | 0.80 | 0.85 | 0.90 |
| Standoff | A1 | 0.00 | 0.02 | 0.05 |
| Terminal Thickness | A3 | 0.203 REF | | |
| Overall Length | D | 3.00 BSC | | |
| Exposed Pad Length | D2 | 2.35 | 2.40 | 2.45 |
| Overall Width | E | 3.00 BSC | | |
| Exposed Pad Width | E2 | 1.65 | 1.70 | 1.75 |
| Terminal Width | b | 0.20 | 0.25 | 0.30 |
| Terminal Length | L | 0.35 | 0.40 | 0.45 |
| Terminal-to-Exposed-Pad | K | 0.20 | - | - |

Notes:

1. Pin 1 visual index feature may vary, but must be located within the hatched area.
2. Package is saw singulated
3. Dimensioning and tolerancing per ASME Y14.5M
BSC: Basic Dimension. Theoretically exact value shown without tolerances.
REF: Reference Dimension, usually without tolerance, for information purposes only.

Microchip Technology Drawing C04-1019-JFA Rev A Sheet 2 of 2

10-Lead VDFN (ML) Recommended Land Pattern



10-Lead Very Thin Plastic Dual Flat, No Lead Package (JFA) - 3x3x0.9 mm Body [VDFN] Micrel Legacy Package DFN33-10LD-PL-1

Note: For the most current package drawings, please see the Microchip Packaging Specification located at <http://www.microchip.com/packaging>

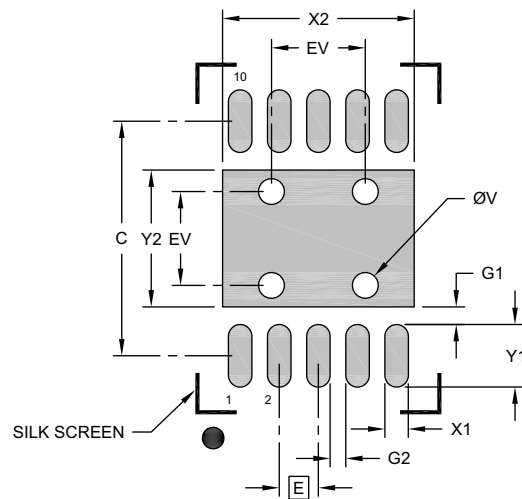

RECOMMENDED LAND PATTERN

| Dimension Limits | Units | MILLIMETERS | | |
|----------------------------------|-------|-------------|------|------|
| | | MIN | NOM | MAX |
| Contact Pitch | E | 0.50 BSC | | |
| Optional Center Pad Width | X2 | | | 2.45 |
| Optional Center Pad Length | Y2 | | | 1.75 |
| Contact Pad Spacing | C | 3.00 | | |
| Contact Pad Width (Xnn) | X1 | | | 0.30 |
| Contact Pad Length (Xnn) | Y1 | | | 0.80 |
| Contact Pad to Center Pad (Xnn) | G1 | 0.23 | | |
| Contact Pad to Contact Pad (Xnn) | G2 | 0.20 | | |
| Thermal Via Diameter | V | | 0.33 | |
| Thermal Via Pitch | EV | | 1.20 | |

Notes:

1. Dimensioning and tolerancing per ASME Y14.5M
BSC: Basic Dimension. Theoretically exact value shown without tolerances.
2. For best soldering results, thermal vias, if used, should be filled or tented to avoid solder loss during reflow process

Microchip Technology Drawing C04-3019-JFA Rev A

© 2019 Microchip Technology Incorporated

MIC2205

NOTES:

APPENDIX A: REVISION HISTORY

Revision A (May 2019)

- Converted Micrel document MIC2205 to Microchip data sheet DS20006177A.
- Minor text changes throughout.

MIC2205

NOTES:

PRODUCT IDENTIFICATION SYSTEM

To order or obtain information, e.g., on pricing or delivery, contact your local Microchip representative or sales office.

| PART NO. | -X.XX | X | XX | -XX |
|--|--|----------------------------|---------|------------|
| Device | Output Voltage | Junction Temperature Range | Package | Media Type |
| Device: | MIC2205: 2 MHz PWM Synchronous Buck Regulator with LDO Standby Mode | | | |
| Output Voltage: | Blank = Adjustable 1.3 = 1.3V 1.38 = 1.38V 1.5 = 1.5V 1.58 = 1.58V 1.8 = 1.8V 1.85 = 1.85V | | | |
| Junction Temperature Range: | Y = -40°C to +125°C, RoHS Compliant | | | |
| Package: | ML = 10-Lead 3 mm x 3 mm x 0.9 mm VDFN | | | |
| Media Type: | TR = 5,000/Reel | | | |
| Note: Other voltage options available. Contact your Microchip Sales Office. | | | | |
| Examples: <ul style="list-style-type: none"> a) MIC2205YML-TR: 2 MHz PWM Synchronous Buck Regulator with LDO Standby Mode, Adjustable Output Voltage, -40°C to +125°C Temp. Range, RoHS Compliant, 10-Lead 3 mm x 3 mm VDFN Package, 5000/Reel b) MIC2205-1.3YML-TR: 2 MHz PWM Synchronous Buck Regulator with LDO Standby Mode, 1.3V Fixed Output Voltage, -40°C to +125°C Temp. Range, RoHS Compliant, 10-Lead 3 mm x 3 mm VDFN Package, 5000/Reel c) MIC2205-1.38YML-TR: 2 MHz PWM Synchronous Buck Regulator with LDO Standby Mode, 1.38V Fixed Output Voltage, -40°C to +125°C Temp. Range, RoHS Compliant, 10-Lead 3 mm x 3 mm VDFN Package, 5000/Reel d) MIC2205-1.58YML-TR: 2 MHz PWM Synchronous Buck Regulator with LDO Standby Mode, 1.58V Fixed Output Voltage, -40°C to +125°C Temp. Range, RoHS Compliant, 10-Lead 3 mm x 3 mm VDFN Package, 5000/Reel e) MIC2205-1.8YML-TR: 2 MHz PWM Synchronous Buck Regulator with LDO Standby Mode, 1.8V Fixed Output Voltage, -40°C to +125°C Temp. Range, RoHS Compliant, 10-Lead 3 mm x 3 mm VDFN Package, 5000/Reel | | | | |
| Note 1: Tape and Reel identifier only appears in the catalog part number description. This identifier is used for ordering purposes and is not printed on the device package. Check with your Microchip Sales Office for package availability with the Tape and Reel option. | | | | |

MIC2205

NOTES:

Note the following details of the code protection feature on Microchip devices:

- Microchip products meet the specification contained in their particular Microchip Data Sheet.
- Microchip believes that its family of products is one of the most secure families of its kind on the market today, when used in the intended manner and under normal conditions.
- There are dishonest and possibly illegal methods used to breach the code protection feature. All of these methods, to our knowledge, require using the Microchip products in a manner outside the operating specifications contained in Microchip's Data Sheets. Most likely, the person doing so is engaged in theft of intellectual property.
- Microchip is willing to work with the customer who is concerned about the integrity of their code.
- Neither Microchip nor any other semiconductor manufacturer can guarantee the security of their code. Code protection does not mean that we are guaranteeing the product as “unbreakable.”

Code protection is constantly evolving. We at Microchip are committed to continuously improving the code protection features of our products. Attempts to break Microchip's code protection feature may be a violation of the Digital Millennium Copyright Act. If such acts allow unauthorized access to your software or other copyrighted work, you may have a right to sue for relief under that Act.

Information contained in this publication regarding device applications and the like is provided only for your convenience and may be superseded by updates. It is your responsibility to ensure that your application meets with your specifications. MICROCHIP MAKES NO REPRESENTATIONS OR WARRANTIES OF ANY KIND WHETHER EXPRESS OR IMPLIED, WRITTEN OR ORAL, STATUTORY OR OTHERWISE, RELATED TO THE INFORMATION, INCLUDING BUT NOT LIMITED TO ITS CONDITION, QUALITY, PERFORMANCE, MERCHANTABILITY OR FITNESS FOR PURPOSE. Microchip disclaims all liability arising from this information and its use. Use of Microchip devices in life support and/or safety applications is entirely at the buyer's risk, and the buyer agrees to defend, indemnify and hold harmless Microchip from any and all damages, claims, suits, or expenses resulting from such use. No licenses are conveyed, implicitly or otherwise, under any Microchip intellectual property rights unless otherwise stated.

Microchip received ISO/TS-16949:2009 certification for its worldwide headquarters, design and wafer fabrication facilities in Chandler and Tempe, Arizona; Gresham, Oregon and design centers in California and India. The Company's quality system processes and procedures are for its PIC® MCUs and dsPIC® DSCs, KEELoq® code hopping devices, Serial EEPROMs, microperipherals, nonvolatile memory and analog products. In addition, Microchip's quality system for the design and manufacture of development systems is ISO 9001:2000 certified.

**QUALITY MANAGEMENT SYSTEM
CERTIFIED BY DNV
= ISO/TS 16949 =**

Trademarks

The Microchip name and logo, the Microchip logo, AnyRate, AVR, AVR logo, AVR Freaks, BitCloud, chipKIT, chipKIT logo, CryptoMemory, CryptoRF, dsPIC, FlashFlex, flexPWR, Heldo, JukeBlox, KeeLoq, Klear, LANCheck, LINK MD, maXStylus, maXTouch, MediaLB, megaAVR, MOST, MOST logo, MPLAB, OptoLyzer, PIC, picoPower, PICSTART, PIC32 logo, Prochip Designer, QTouch, SAM-BA, SpyNIC, SST, SST Logo, SuperFlash, tinyAVR, UNI/O, and XMEGA are registered trademarks of Microchip Technology Incorporated in the U.S.A. and other countries.

ClockWorks, The Embedded Control Solutions Company, EtherSynch, Hyper Speed Control, HyperLight Load, IntellIMOS, mTouch, Precision Edge, and Quiet-Wire are registered trademarks of Microchip Technology Incorporated in the U.S.A.

Adjacent Key Suppression, AKS, Analog-for-the-Digital Age, Any Capacitor, AnyIn, AnyOut, BodyCom, CodeGuard, CryptoAuthentication, CryptoAutomotive, CryptoCompanion, CryptoController, dsPICDEM, dsPICDEM.net, Dynamic Average Matching, DAM, ECAN, EtherGREEN, In-Circuit Serial Programming, ICSP, INICnet, Inter-Chip Connectivity, JitterBlocker, KlearNet, KlearNet logo, memBrain, Mindi, MiWi, motorBench, MPASM, MPF, MPLAB Certified logo, MPLIB, MPLINK, MultiTRAK, NetDetach, Omniscient Code Generation, PICDEM, PICDEM.net, PICKit, PICtail, PowerSmart, PureSilicon, QMatrix, REAL ICE, Ripple Blocker, SAM-ICE, Serial Quad I/O, SMART-I.S., SQI, SuperSwitcher, SuperSwitcher II, Total Endurance, TSHARC, USBCheck, VariSense, ViewSpan, WiperLock, Wireless DNA, and ZENA are trademarks of Microchip Technology Incorporated in the U.S.A. and other countries.

SQTP is a service mark of Microchip Technology Incorporated in the U.S.A.

Silicon Storage Technology is a registered trademark of Microchip Technology Inc. in other countries.

GestIC is a registered trademark of Microchip Technology Germany II GmbH & Co. KG, a subsidiary of Microchip Technology Inc., in other countries.

All other trademarks mentioned herein are property of their respective companies.

© 2018, Microchip Technology Incorporated, All Rights Reserved.
ISBN: 978-1-5224-4569-2



MICROCHIP

Worldwide Sales and Service

AMERICAS

Corporate Office
2355 West Chandler Blvd.
Chandler, AZ 85224-6199
Tel: 480-792-7200
Fax: 480-792-7277
Technical Support:
<http://www.microchip.com/support>
Web Address:
www.microchip.com

Atlanta

Duluth, GA
Tel: 678-957-9614
Fax: 678-957-1455

Austin, TX

Tel: 512-257-3370

Boston

Westborough, MA
Tel: 774-760-0087
Fax: 774-760-0088

Chicago

Itasca, IL
Tel: 630-285-0071
Fax: 630-285-0075

Dallas

Addison, TX
Tel: 972-818-7423
Fax: 972-818-2924

Detroit

Novi, MI
Tel: 248-848-4000

Houston, TX

Tel: 281-894-5983

Indianapolis

Noblesville, IN
Tel: 317-773-8323
Fax: 317-773-5453
Tel: 317-536-2380

Los Angeles

Mission Viejo, CA
Tel: 949-462-9523
Fax: 949-462-9608
Tel: 951-273-7800

Raleigh, NC

Tel: 919-844-7510

New York, NY

Tel: 631-435-6000

San Jose, CA

Tel: 408-735-9110
Tel: 408-436-4270

Canada - Toronto

Tel: 905-695-1980
Fax: 905-695-2078

ASIA/PACIFIC

Australia - Sydney
Tel: 61-2-9868-6733

China - Beijing
Tel: 86-10-8569-7000

China - Chengdu
Tel: 86-28-8665-5511

China - Chongqing
Tel: 86-23-8980-9588

China - Dongguan
Tel: 86-769-8702-9880

China - Guangzhou
Tel: 86-20-8755-8029

China - Hangzhou
Tel: 86-571-8792-8115

China - Hong Kong SAR
Tel: 852-2943-5100

China - Nanjing
Tel: 86-25-8473-2460

China - Qingdao
Tel: 86-532-8502-7355

China - Shanghai
Tel: 86-21-3326-8000

China - Shenyang
Tel: 86-24-2334-2829

China - Shenzhen
Tel: 86-755-8864-2200

China - Suzhou
Tel: 86-186-6233-1526

China - Wuhan
Tel: 86-27-5980-5300

China - Xian
Tel: 86-29-8833-7252

China - Xiamen
Tel: 86-592-2388138

China - Zhuhai
Tel: 86-756-3210040

ASIA/PACIFIC

India - Bangalore
Tel: 91-80-3090-4444

India - New Delhi
Tel: 91-11-4160-8631

India - Pune
Tel: 91-20-4121-0141

Japan - Osaka
Tel: 81-6-6152-7160

Japan - Tokyo
Tel: 81-3-6880-3770

Korea - Daegu
Tel: 82-53-744-4301

Korea - Seoul
Tel: 82-2-554-7200

Malaysia - Kuala Lumpur
Tel: 60-3-7651-7906

Malaysia - Penang
Tel: 60-4-227-8870

Philippines - Manila
Tel: 63-2-634-9065

Singapore
Tel: 65-6334-8870

Taiwan - Hsin Chu
Tel: 886-3-577-8366

Taiwan - Kaohsiung
Tel: 886-7-213-7830

Taiwan - Taipei
Tel: 886-2-2508-8600

Thailand - Bangkok
Tel: 66-2-694-1351

Vietnam - Ho Chi Minh
Tel: 84-28-5448-2100

EUROPE

Austria - Wels
Tel: 43-7242-2244-39
Fax: 43-7242-2244-393

Denmark - Copenhagen
Tel: 45-4450-2828
Fax: 45-4485-2829

Finland - Espoo
Tel: 358-9-4520-820

France - Paris
Tel: 33-1-69-53-63-20
Fax: 33-1-69-30-90-79

Germany - Garching
Tel: 49-8931-9700

Germany - Haan
Tel: 49-2129-3766400

Germany - Heilbronn
Tel: 49-7131-67-3636

Germany - Karlsruhe
Tel: 49-721-625370

Germany - Munich
Tel: 49-89-627-144-0
Fax: 49-89-627-144-44

Germany - Rosenheim
Tel: 49-8031-354-560

Israel - Ra'anana
Tel: 972-9-744-7705

Italy - Milan
Tel: 39-0331-742611
Fax: 39-0331-466781

Italy - Padova
Tel: 39-049-7625286

Netherlands - Drunen
Tel: 31-416-690399
Fax: 31-416-690340

Norway - Trondheim
Tel: 47-7288-4388

Poland - Warsaw
Tel: 48-22-3325737

Romania - Bucharest
Tel: 40-21-407-87-50

Spain - Madrid
Tel: 34-91-708-08-90
Fax: 34-91-708-08-91

Sweden - Gothenberg
Tel: 46-31-704-60-40

Sweden - Stockholm
Tel: 46-8-5090-4654

UK - Wokingham
Tel: 44-118-921-5800
Fax: 44-118-921-5820