

TLF-100S-4PMS

4 Pole Fuse terminal Vertical mm pitch 20A(UL)24A(VDE)A 300V(UL)450V(VDE)V

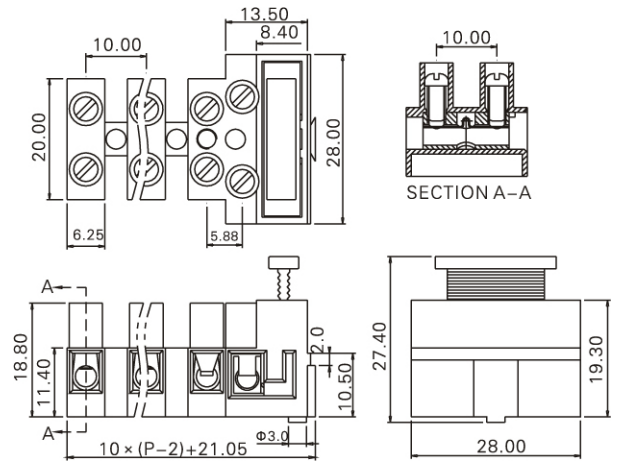

SPECIFICATION

Connection Method	Fuse terminal
Mounting Type	Vertical
Orientation	Vertical
Join	Solid body non stackable
Number of Poles	4
Max Current (A)	20A(UL)24A(VDE)
Max Voltage (V)	300V(UL)450V(VDE)
Height (mm)	27.4
Standard Colour	Gray
Width (mm)	28
Length (mm)	41.05