

## General Description

The MAX20014 evaluation kit (EV kit) is a fully assembled and tested PCB that demonstrates the MAX20014 power management IC (PMIC). The EV kit includes three high-efficiency, low-voltage DC-DC converters: OUT1 boosts a 3.3V input to 5V at up to 500mA, while two synchronous step-down converters (OUT2, OUT3) provide adjustable output voltages down to 0.8V at up to 3A. The 2.2MHz switching-frequency operation allows for the use of all-ceramic capacitors and minimizes external components.

The EV kits feature three on/off jumper controls, and three reset outputs to indicate output status for each converter. It also provides SYNC input to select the operating mode (PWM, skip, or external synchronization).

## Benefits and Features

- 3.0V to 5.5V Operating Supply Voltage
- 5V at 500mA Synchronous Boost Converter (OUT1)
- 1.25V at 3A Synchronous Buck Converter (OUT2)
- 1.8V at 3A Synchronous Buck Converter (OUT3)
- Sync-Mode Select/Input for Forced-PWM/Skip Mode Selection or External Frequency Synchronization
- Individual  $\overline{\text{RESET1}}$ – $\overline{\text{RESET3}}$  Outputs
- Minimal External Components
- Proven PCB Layout
- Fully Assembled and Tested

## Quick Start

### Required Equipment

- MAX20014 EV kit
- Variable 6V power supply capable of supplying 5A
- Electronic load
- Two voltmeters

**Ordering Information** appears at end of data sheet.

## Procedure

The EV kit is fully assembled and tested. Follow the steps below to verify board operation. **Caution: Do not turn on the power supply until all connections are completed.**

- 1) Preset the power supply to 3.3V. Turn off the power supply.
- 2) Preset the electronic load to 500mA. Turn off the electronic load.
- 3) Connect the positive lead of the power supply to the VSUP PCB pad. Connect the negative lead of the power supply to the PGND PCB pad.
- 4) Connect the positive terminal of the electronic load to the VOUT1 PCB pad. Connect the negative terminal of the electronic load to the PGND1 PCB pad.
- 5) Enable outputs  $V_{\text{OUT1}}$ – $V_{\text{OUT3}}$  by installing shunts on jumpers EN1–EN3.
- 6) Install a shunt on SYNC1 to enable forced-PWM (FPWM) operation.
- 7) Turn on the power supply.
- 8) Verify that voltage across the VOUT1 and PGND1 PCB pads is  $5V \pm 1\%$ .
- 9) Verify that voltage across the  $\overline{\text{RESET1}}$  and PGND PCB pads is 3.3V.
- 10) Turn on the electronic load.
- 11) Verify that voltage across the VOUT1 and PGND1 PCB pads is  $5V \pm 2\%$ .
- 12) Turn off the electronic load.
- 13) Remove the electronic load from the VOUT1 and PGND1 PCB pads.
- 14) Connect the positive terminal of the electronic load to the VOUT2 PCB pad. Connect the negative terminal of the electronic load to the PGND2 PCB pad. Preset the electronic load to 3A.
- 15) Verify that voltage across the VOUT2 and PGND2 PCB pads is  $1.25V \pm 2\%$ .
- 16) Verify that voltage the across  $\overline{\text{RESET2}}$  and PGND PCB pads is 3.3V.
- 17) Turn on the electronic load.
- 18) Verify that the voltage across VOUT2 and PGND2 pads is  $1.25V \pm 3\%$ .

- 19) Turn off the electronic load.
- 20) Remove the electronic load from VOUT2 and PGND2 pads.
- 21) Connect the positive terminal of the electronic load to the VOUT3 PCB pad. Connect the negative terminal of the electronic load to the PGND3 pad. Preset the electronic load to 3A.
- 22) Verify that the voltage across the VOUT3 and PGND3 PCB pads is 1.8V ±2%.
- 23) Verify that the voltage across the  $\overline{\text{RESET3}}$  and PGND PCB pads is 3.3V.
- 24) Turn on the electronic load.
- 25) Verify that the voltage across the VOUT3 and PGND3 PCB pads is in the range of 1.8V ±3%.
- 26) Turn off the electronic load.
- 27) Turn off the power supply.

### Detailed Description

The MAX20014 EV kit integrates three high-efficiency, low-voltage DC-DC converters: OUT1 is a synchronous boost converter that boosts a 3.3V input to 5.0V at up to 500mA, while two synchronous step-down converters (OUT2, OUT3) provide adjustable output voltages down to 0.8V at up to 3A.

VOUT1–VOUT3 can be enabled/disabled by the EN1–EN3 jumpers, respectively. The status of input voltage and output voltages is indicated by  $\overline{\text{PV\_OV}}$ , and  $\overline{\text{RESET1}}-\overline{\text{RESET3}}$ .

### Adjustable Buck Output Voltage (VOUT2 and VOUT3)

The buck outputs (VOUT2, VOUT3) can be adjusted using the following procedure:

- 1) Choose R<sub>BOTTOM</sub> to be 100kΩ or less.
- 2) Solve for R<sub>TOP</sub> using:
 
$$R_{TOP} = R_{BOTTOM} \times [(V_{OUT\_}/0.8V) - 1]$$
- 3) Install resistors R<sub>TOP</sub> and R<sub>BOTTOM</sub>. R<sub>TOP</sub> refers to R4/R6, while R<sub>BOTTOM</sub> refers to R3/R5 in the EV kit schematic.
- 4) The external feedback resistive divider must be frequency compensated for proper operation. Place a capacitor across R<sub>TOP</sub> in the resistive-divider network. Use the equation below to determine the value of the feed-forward capacitor:

$$C_{FF} = 50 \times R_{BOTTOM}/R_{TOP} \text{ pF}$$

### Operation Mode

The EV kit features a jumper (SYNC1) to configure the device operation mode. Install a shunt on SYNC1 to enter FPWM mode. Remove the shunt on SYNC1 to enable skip mode under light-load conditions. Connect an external clock with 1.8MHz to 2.6MHz frequency to synchronize the internal oscillator to an external clock. [Table 1](#) summarizes the functions of SYNC1.

### Enable Control (EN1–EN3)

The EN1–EN3 jumpers are used to enable or disable VOUT1, VOUT2, and VOUT3, respectively. Install shunts on EN1, EN2, or EN3 to enable VOUT1, VOUT2, or VOUT3 normal operation. Remove shunts on EN1, EN2, or EN3 to enter shutdown mode. See [Table 2](#) for enable control.

### Reset Outputs ( $\overline{\text{RESET1}}-\overline{\text{RESET3}}$ )

The EV kit also include three  $\overline{\text{RESET}}$  outputs to monitor VOUT1, VOUT2, and VOUT3 output status. The  $\overline{\text{RESET}}$  output becomes high impedance and is pulled to V<sub>SUP</sub> when the corresponding output voltage is within the specified UV/OV range.  $\overline{\text{RESET}}$  goes low when the corresponding output voltage is not within the specified UV/OV range.

**Table 1. Operation Mode (SYNC1)**

SHUNT POSITION	MODE
ON	FPWM
OFF	Skip
OFF (an external clock connected to SYNC pad)	Synchronize to external clock

**Table 2. Enable Control (EN1–EN3)**

SHUNT POSITION	MODE
ON	Normal Operation
OFF	Shutdown

### Ordering Information

PART	TYPE
MAX20014EVKIT#	EV Kit

#Denotes RoHS compliant.

## MAX20014 EV Kit Component List

DESIGNATION	QTY	DESCRIPTION
C1	1	10 $\mu$ F 16V X6S Ceramic Capacitor (0805)
		Murata GRT21BC81C106KE01L
C2, C3	2	47 $\mu$ F 4V X6S Ceramic Capacitor (0805)
		Murata GRT21BC80G476ME13L
C4	1	47 $\mu$ F 16V Aluminum Capacitor
		Panasonic EEEFC1C470P
C5, C6	2	4.7 $\mu$ F 16V X7R Ceramic Capacitor (1206)
		TDK CGA5L3X7R1C475K160AB
C7	1	1 $\mu$ F 16V X7R Ceramic Capacitor (0603)
		TDK C1608X7R1C105K080AC
C8	1	0.33 $\mu$ F 16V X7R Ceramic Capacitor (0603)
		TDK C1608X7R1C334K080AC
C9	1	8pF 50V C0G Ceramic Capacitor (0603)
		TDK CGA3E2C0G1H080D080AA
C10, C14	0	Not Installed (0805)
C11	1	4.7 $\mu$ F 16V X6S Ceramic Capacitor (0603)
		Murata GRT188C81C475ME13D
C12	1	0 $\Omega$ 1% Resistor (0603)
		TDK CGA3E2X7R1H102K080AA
C13	1	18pF 50V COG Ceramic Capacitor (0603)
		TDK CGA3E2C0G1H180J080AA
EN1, EN2, EN3, SYNC1, WDS	5	2-Pin Header 0.1"
		Sullins: PEC36SAAN or Equivalent
		(36 PIN STRIP, CUT TO SIZE AS NEEDED)
-	5	Shunt, 2 POSITION
		Sullins: STC02SYAN or Equivalent
L1	1	2.2 $\mu$ H Inductor
		TDK TFM252012ALMB2R2MTAA
L2, L3	2	0.47 $\mu$ H Inductor
		TDK TFM252012ALMBR47MTAA
R1	1	10 $\Omega$ 1% Resistor (0603)
R2	1	11.3k $\Omega$ 1% Resistor (0603)
R3, R5, R9, R10, R11	5	20k $\Omega$ 1% Resistor (0603)
R4, R7, R12	3	0 $\Omega$ 1% Resistor (0603)
R6	1	24.9k $\Omega$ 1% Resistor (0603)
R8	0	Not Installed (0603)
U1	1	2.2MHz Sync Boost and Dual Step-Down Converter PMIC
		Maxim MAX20014ATGA/V+ (TQFN 4mm $\times$ 4mm $\times$ 0.75mm)
---	1	PCB: MAX20014 EVKIT

MAX20014 EV Kit Schematic

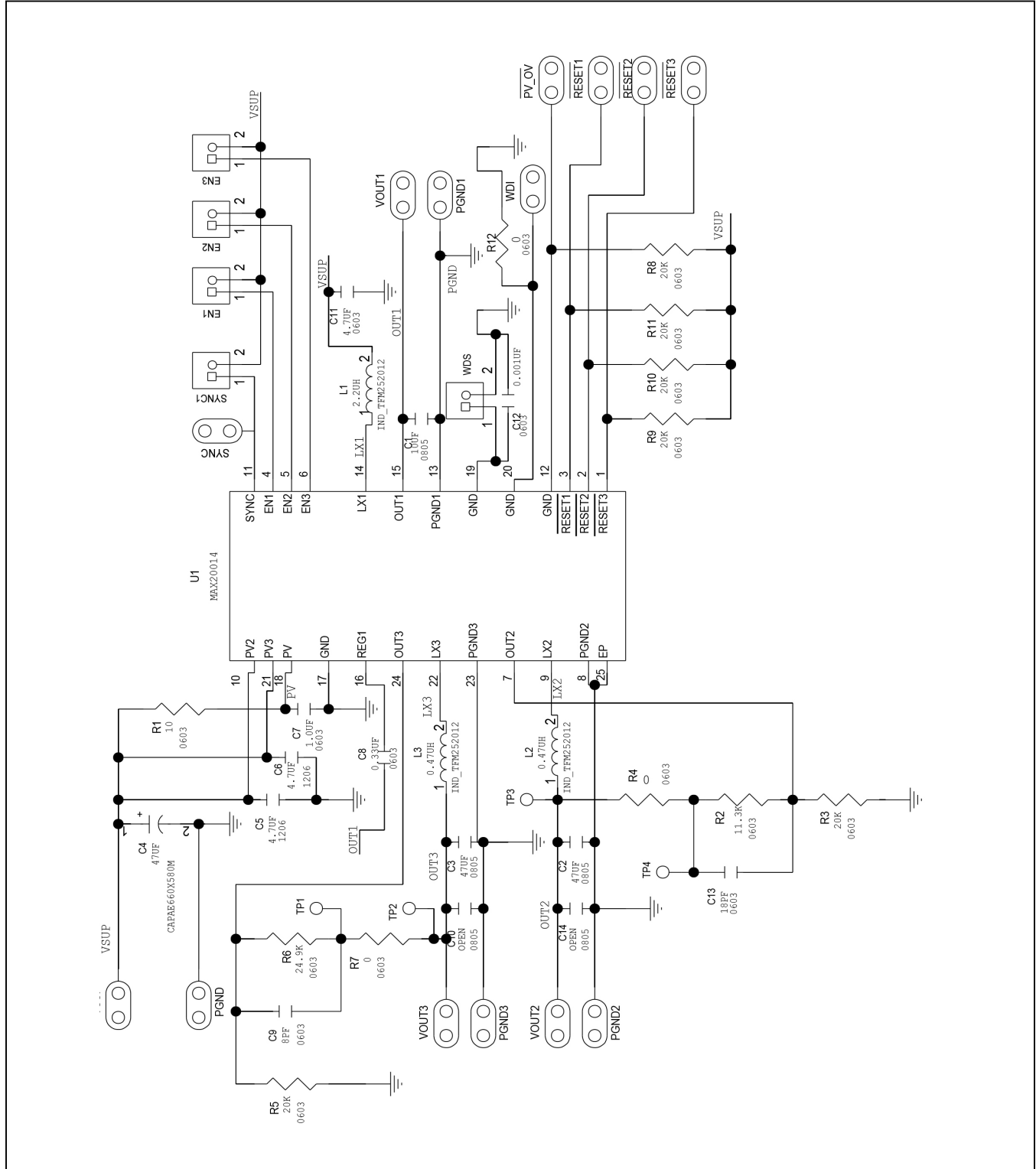

MAX20014 EV Kit Layout Diagrams

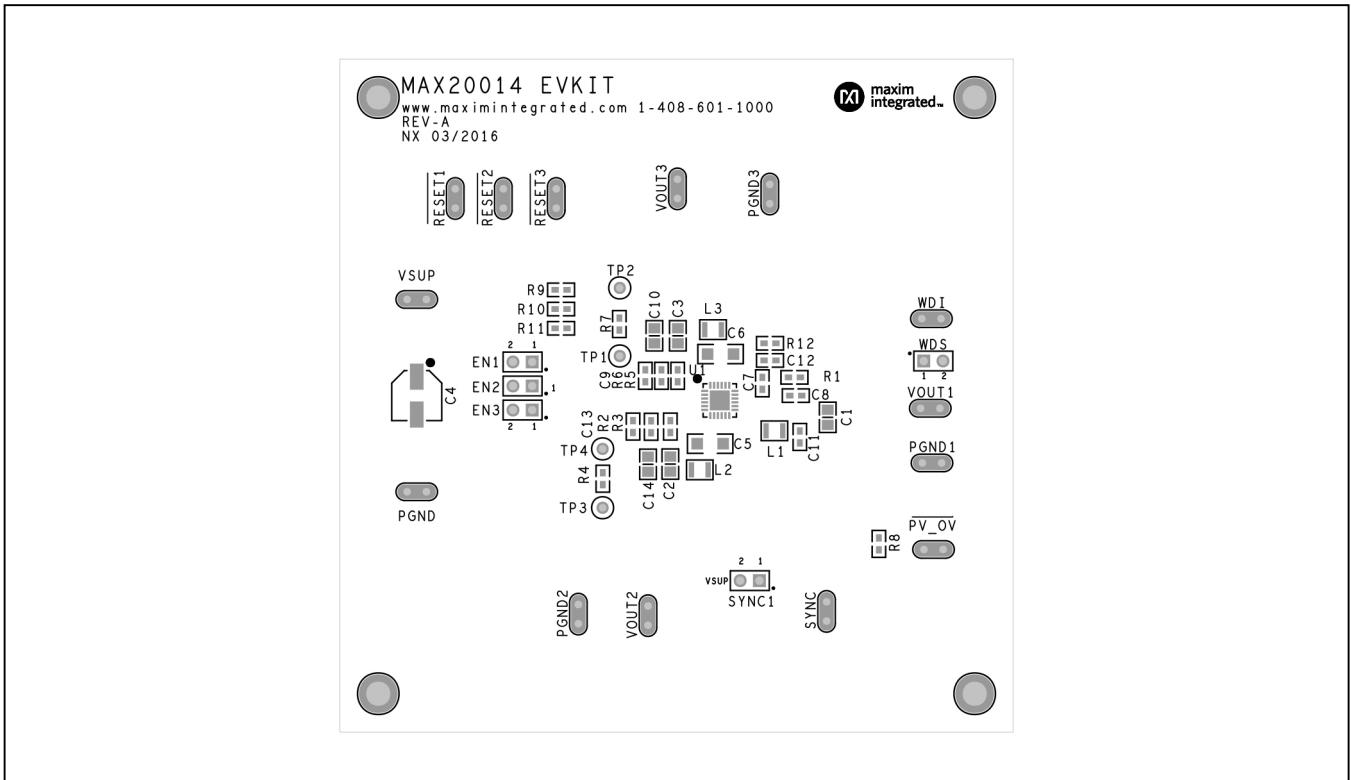

MAX20014 EV Kit Component Placement Guide—Top Silkscreen

MAX20014 EV Kit Layout Diagrams (continued)

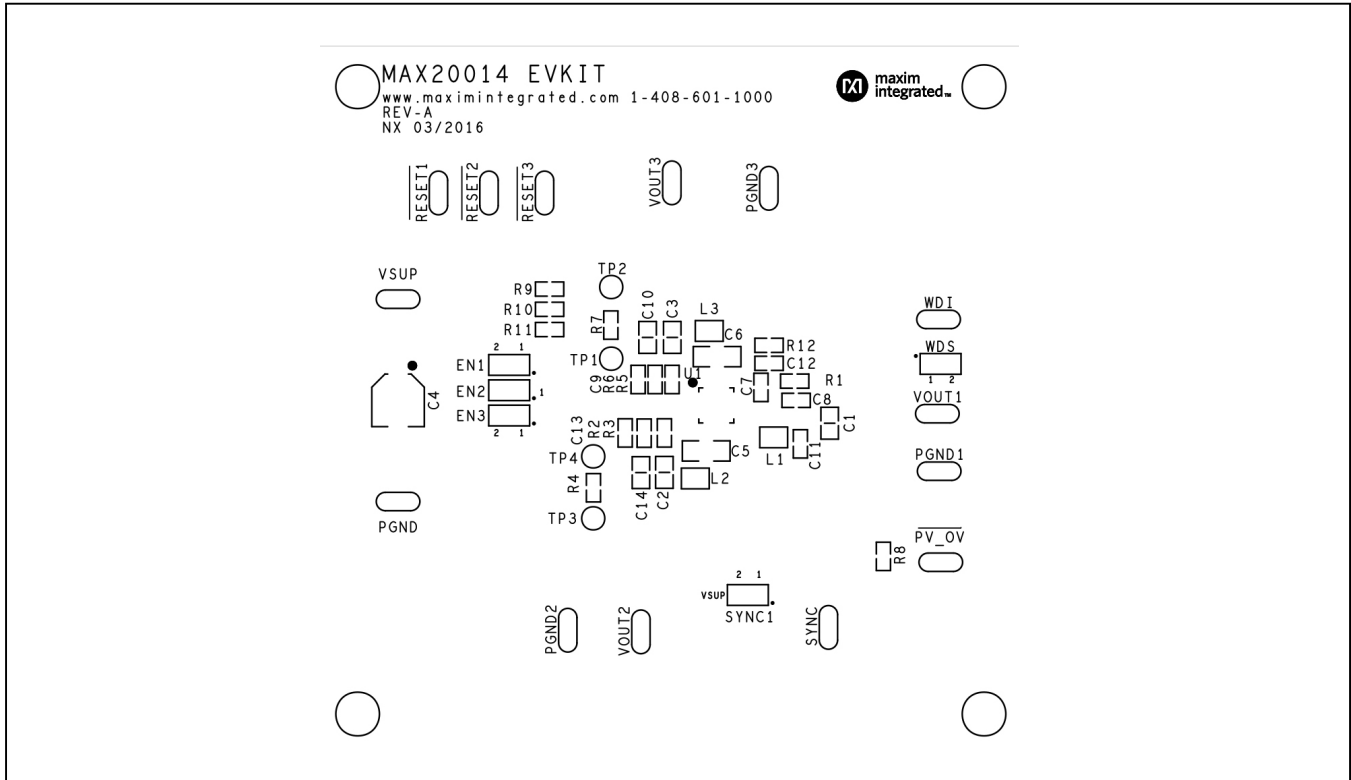

MAX20014 EV Kit Component Placement Guide—Bottom Silkscreen

**MAX20014 EV Kit Layout Diagrams (continued)**

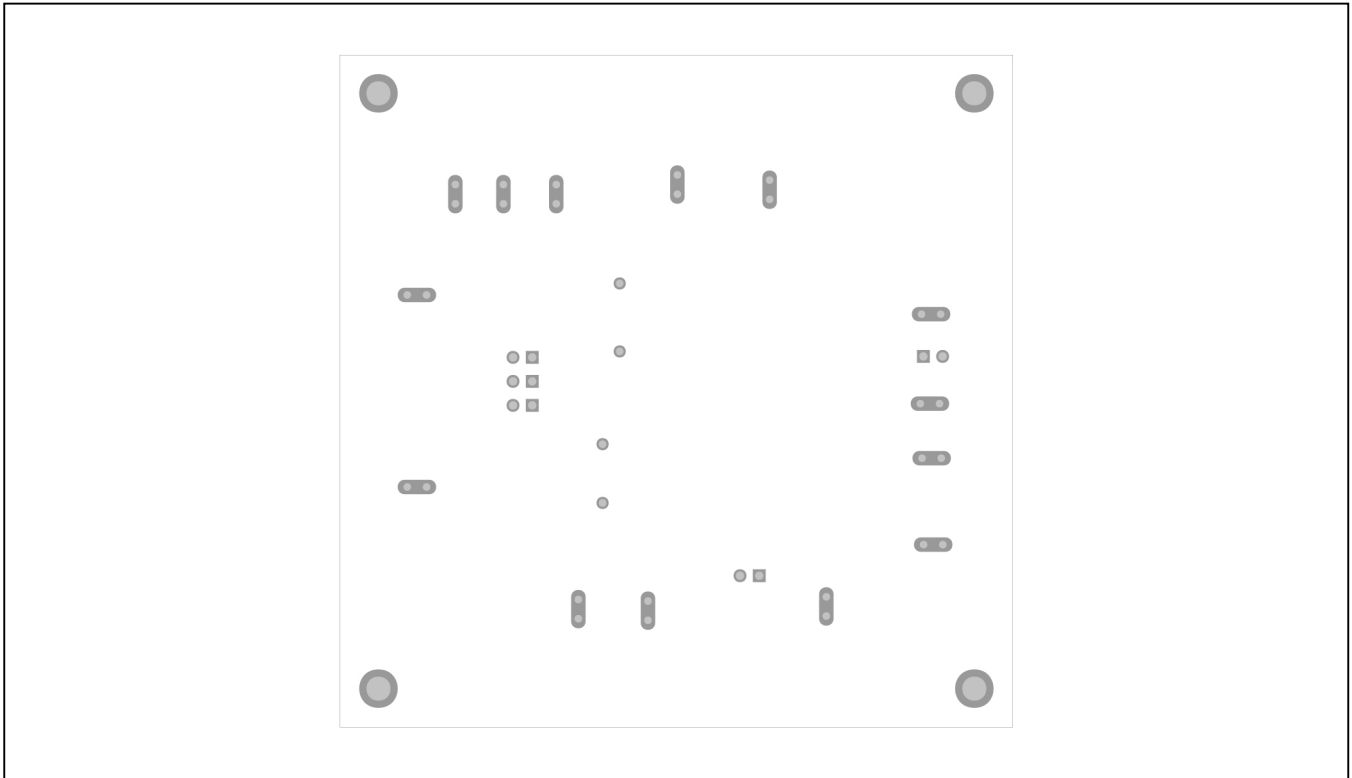

MAX20014 EV Kit PCB Layout—Bottom Mask

**MAX20014 EV Kit Layout Diagrams (continued)**

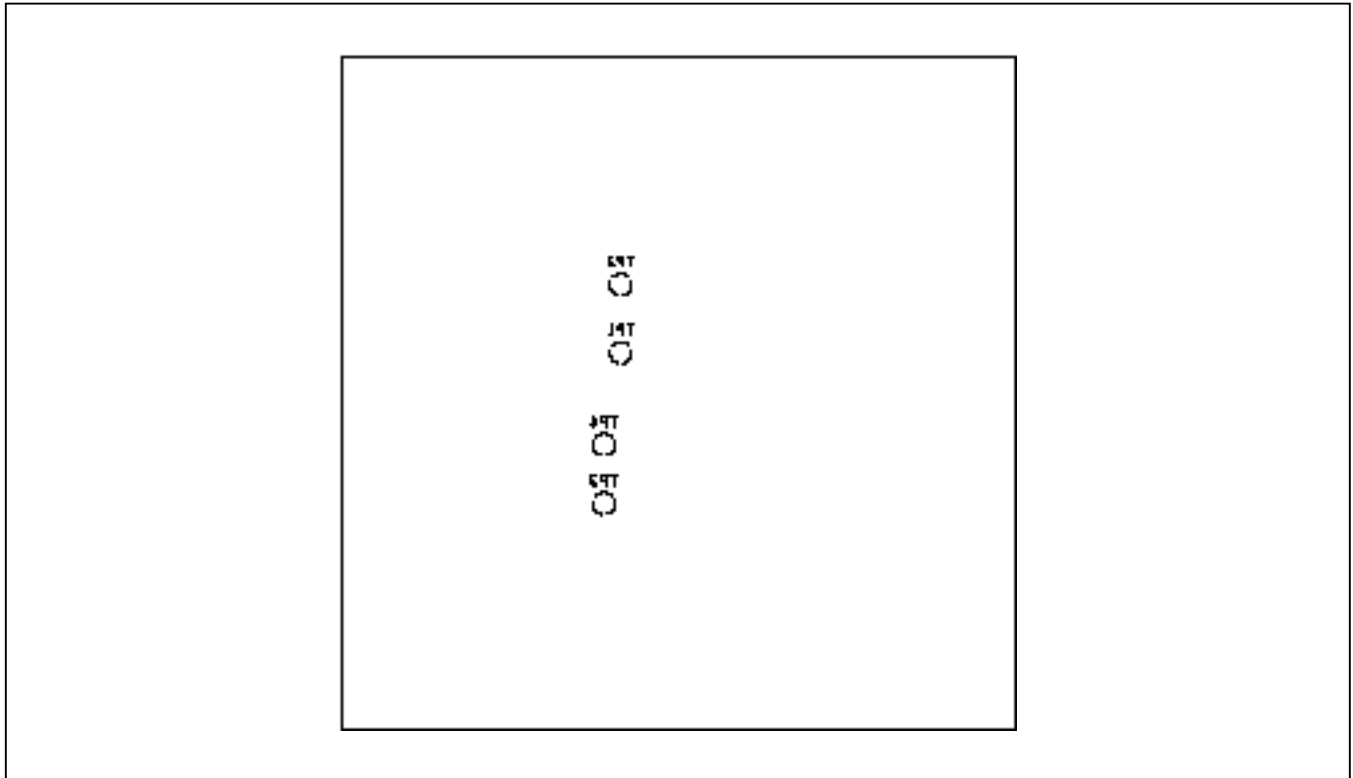

MAX20014 EV Kit PCB Layout—Bottom Silkscreen



**MAX20014 EV Kit Layout Diagrams (continued)**

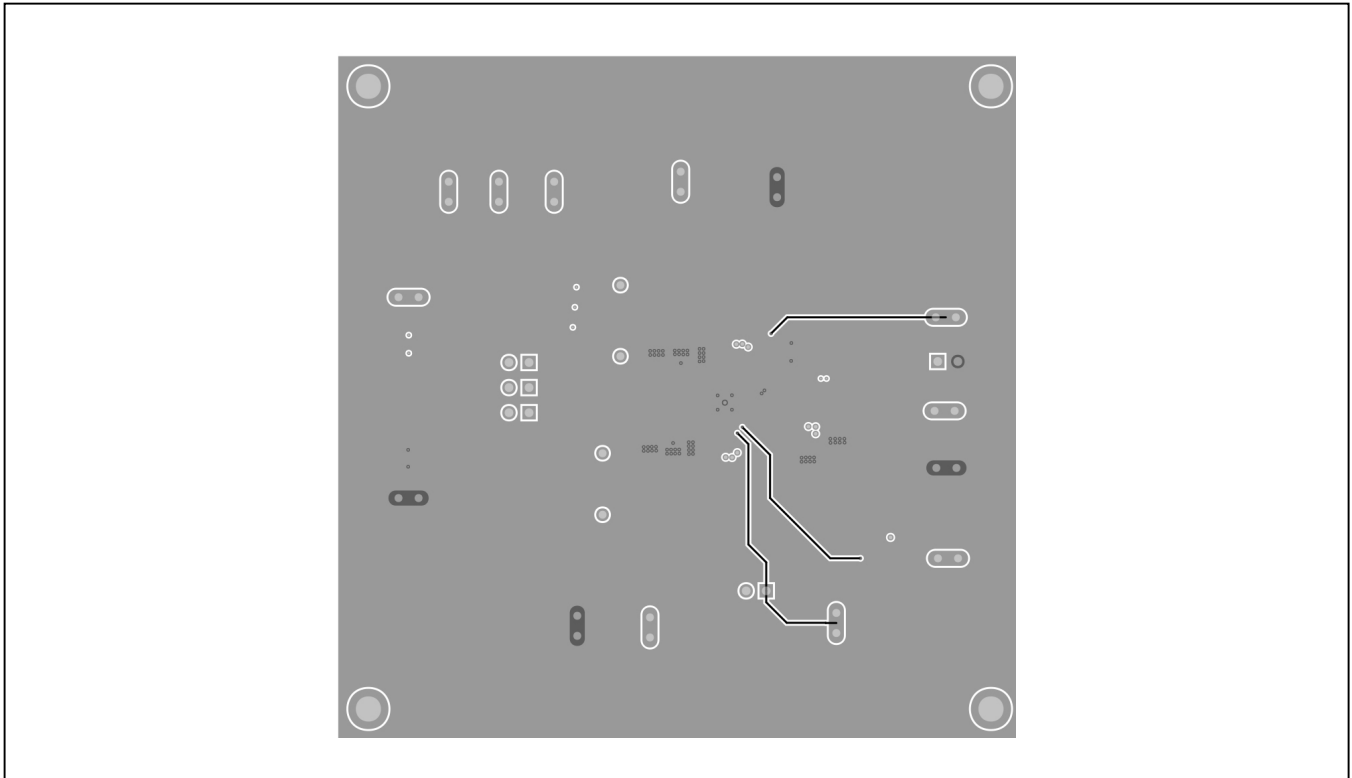

*MAX20014 EV Kit PCB Layout—Bottom*

**MAX20014 EV Kit Layout Diagrams (continued)**

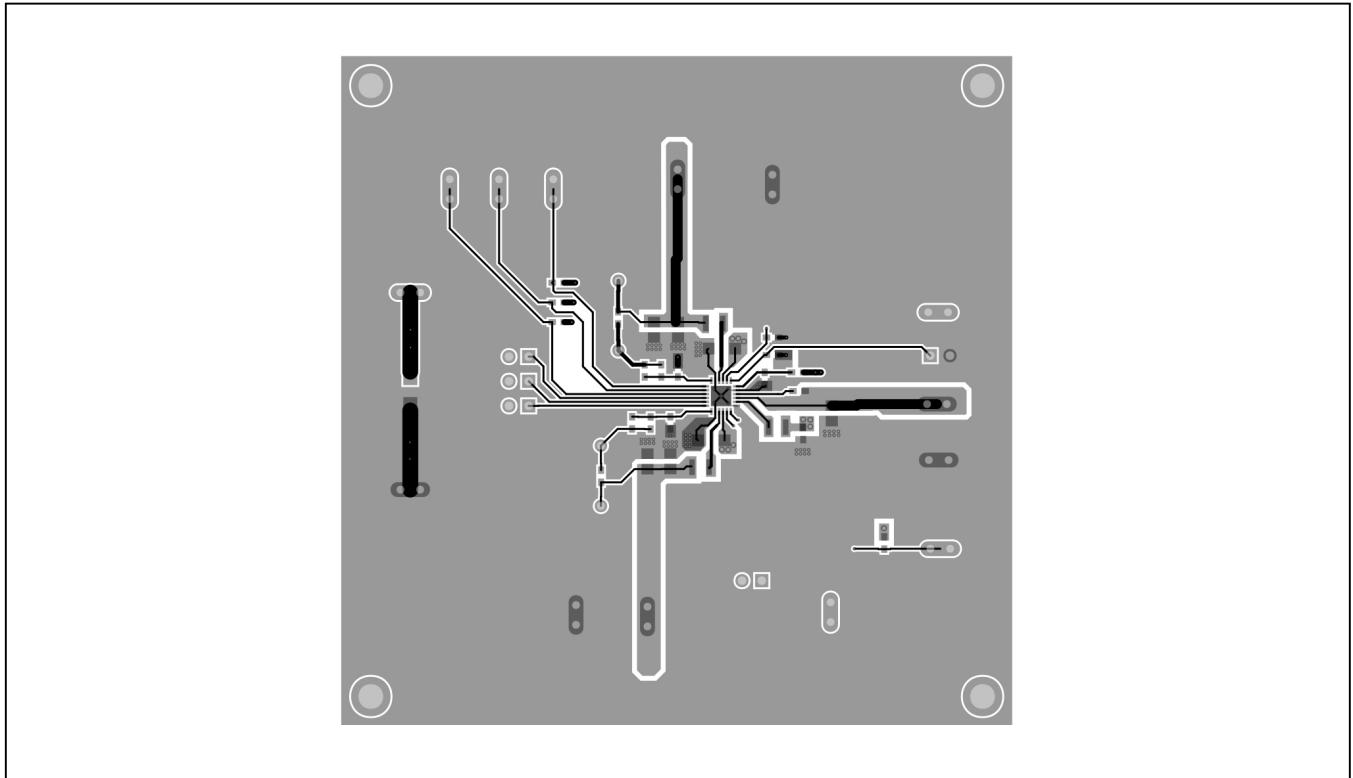

MAX20014 EV Kit PCB Layout—Top

**MAX20014 EV Kit Layout Diagrams (continued)**

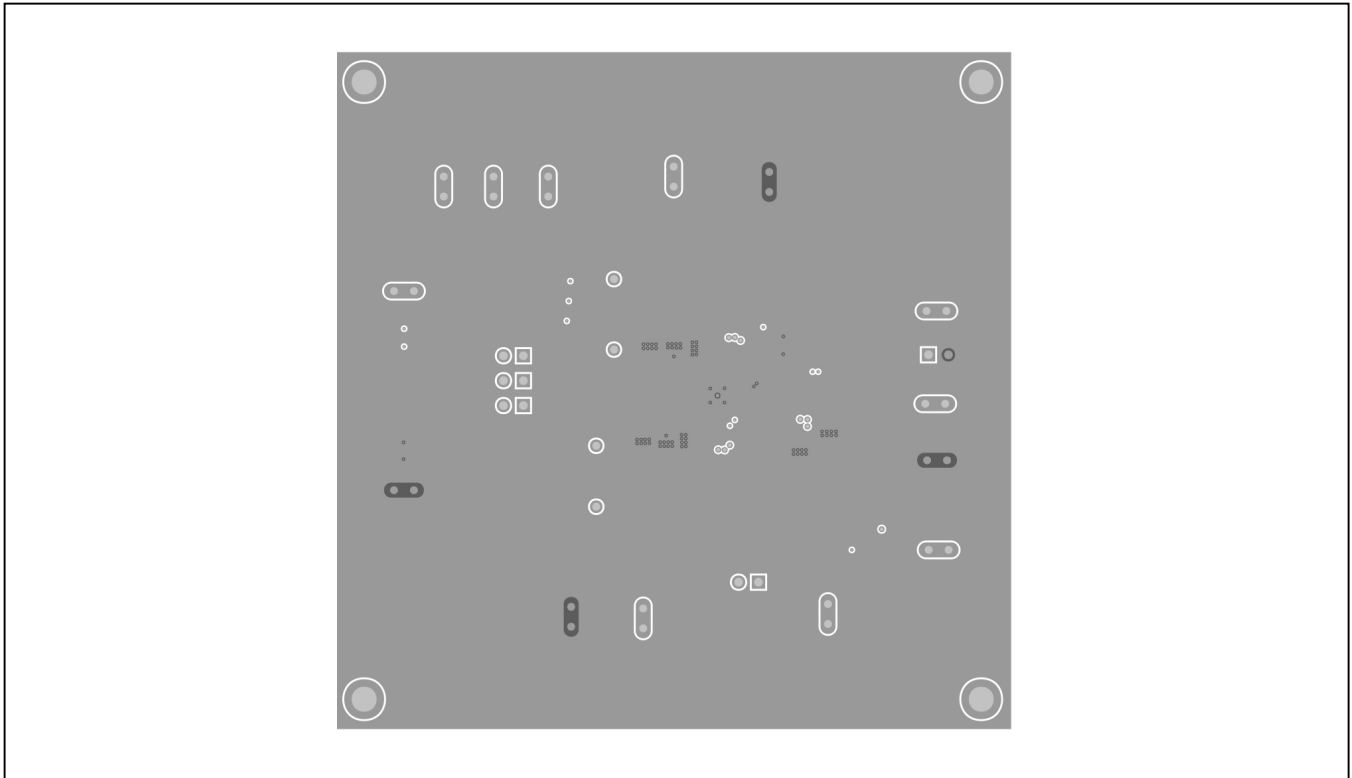

*MAX20014 EV Kit PCB Layout—Internal Layer 2*

**MAX20014 EV Kit Layout Diagrams (continued)**

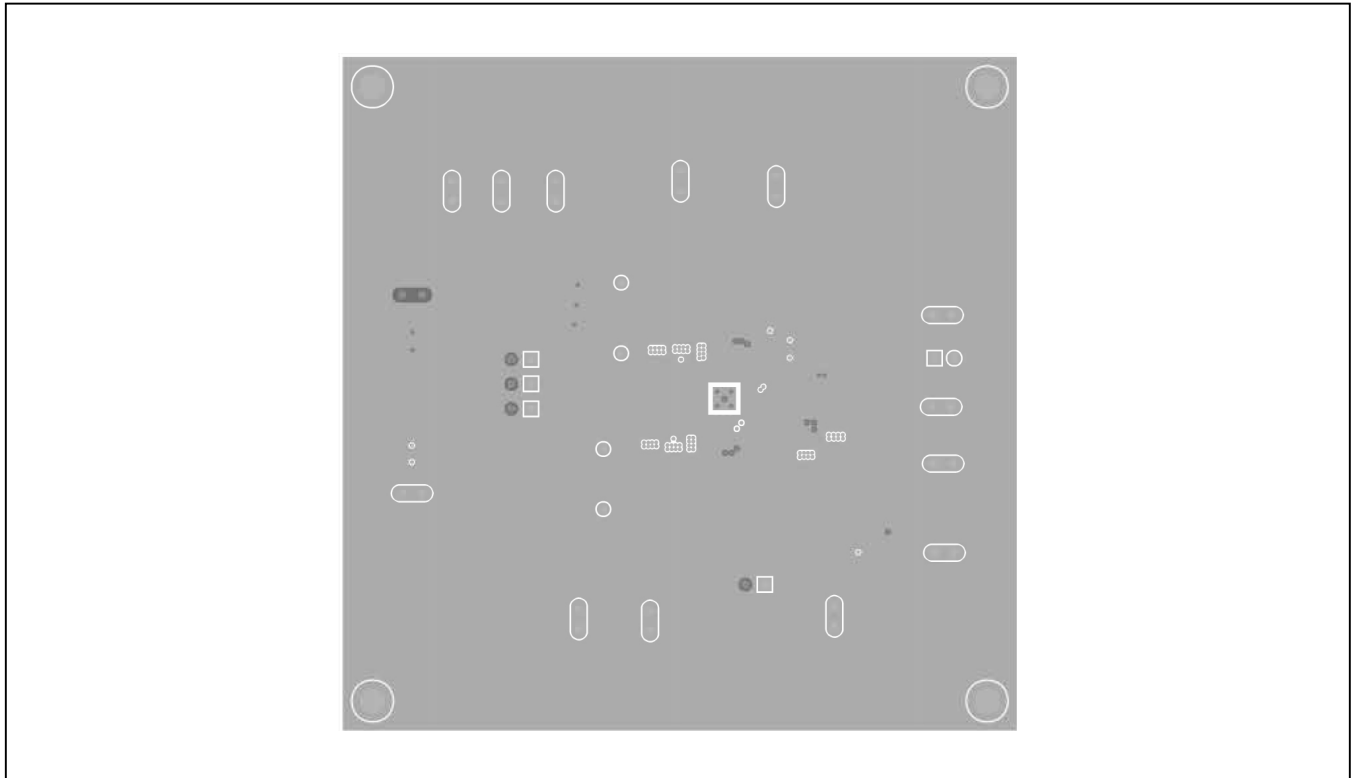

MAX20014 EV Kit PCB Layout—Internal Layer 3

## Revision History

REVISION NUMBER	REVISION DATE	DESCRIPTION	PAGES CHANGED
0	11/16	Initial release	—
1	4/18	Updated the <a href="#">Adjustable Buck Output Voltage (VOUT2 and VOUT3)</a> section	2

For pricing, delivery, and ordering information, please contact Maxim Direct at 1-888-629-4642, or visit Maxim Integrated's website at [www.maximintegrated.com](http://www.maximintegrated.com).

*Maxim Integrated cannot assume responsibility for use of any circuitry other than circuitry entirely embodied in a Maxim Integrated product. No circuit patent licenses are implied. Maxim Integrated reserves the right to change the circuitry and specifications without notice at any time.*