

Major Ratings and Characteristics

Characteristics	31DQ..	Units
$I_{F(AV)}$ Rectangular waveform	3.3	A
V_{RRM}	90/100	V
I_{FSM} @tp = 5 μ s sine	210	A
V_F @3Apk, $T_J = 25^\circ\text{C}$	0.85	V
T_J	-40 to 150	$^\circ\text{C}$

Description/Features

The 31DQ.. axial leaded Schottky rectifier has been optimized for very low forward voltage drop, with moderate leakage. Typical applications are in switching power supplies, converters, free-wheeling diodes, and reverse battery protection.

- Low profile, axial leaded outline
- High purity, high temperature epoxy encapsulation for enhanced mechanical strength and moisture resistance
- Very low forward voltage drop
- High frequency operation
- Guard ring for enhanced ruggedness and long term reliability

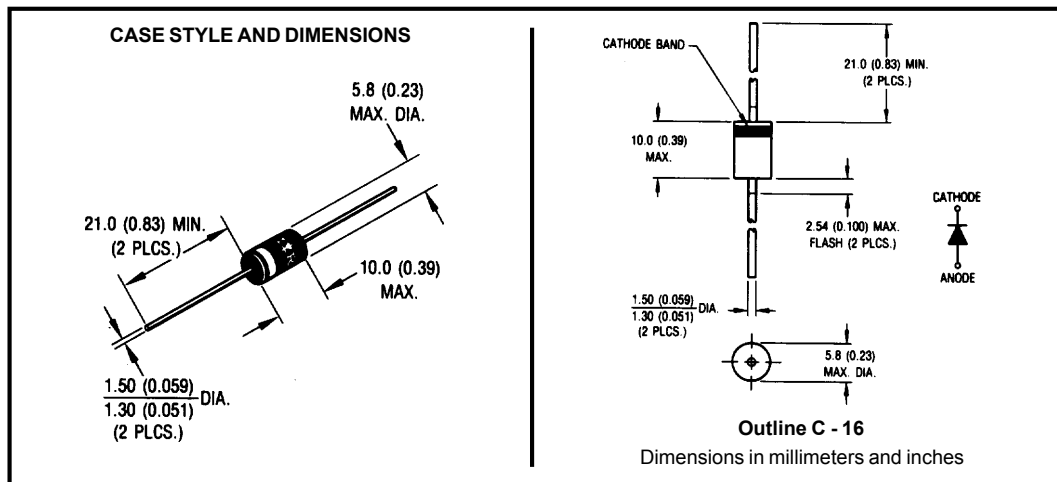

Voltage Ratings

Part number	31DQ09	31DQ10
V_R Max. DC Reverse Voltage (V)	90	100
V_{RWM} Max. Working Peak Reverse Voltage (V)		

Absolute Maximum Ratings

Parameters	31DQ..	Units	Conditions
$I_{F(AV)}$ Max. Average Forward Current * See Fig. 4	3.3	A	50% duty cycle @ $T_L = 53.4^\circ\text{C}$, rectangular waveform With cooling fins
I_{FSM} Max. Peak One Cycle Non-Repetitive Surge Current * See Fig. 6	210	A	Following any rated load condition and with rated V_{RRM} applied
	35		

Electrical Specifications

Parameters	31DQ..	Units	Conditions
V_{FM} Max. Forward Voltage Drop * See Fig. 1 (1)	0.85	V	@ 3A $T_J = 25^\circ\text{C}$
	0.97	V	@ 6A $T_J = 25^\circ\text{C}$
	0.69	V	@ 3A $T_J = 125^\circ\text{C}$
	0.80	V	@ 6A $T_J = 125^\circ\text{C}$
I_{RM} Max. Reverse Leakage Current * See Fig. 2 (1)	1	mA	$T_J = 25^\circ\text{C}$
	3	mA	$T_J = 125^\circ\text{C}$ $V_R = \text{rated } V_R$
C_T Typical Junction Capacitance	110	pF	$V_R = 5V_{DC}$ (test signal range 100Khz to 1Mhz) 25°C
L_S Typical Series Inductance	9.0	nH	Measured lead to lead 5mm from package body
dv/dt Max. Voltage Rate of Change (Rated V_R)	10000	V/ μs	

(1) Pulse Width < 300 μs , Duty Cycle <2%

Thermal-Mechanical Specifications

Parameters	31DQ..	Units	Conditions
T_J Max. Junction Temperature Range	-40 to 150	$^\circ\text{C}$	
T_{stg} Max. Storage Temperature Range	-40 to 150	$^\circ\text{C}$	
R_{thJA} Max. Thermal Resistance Junction to Ambient	80	$^\circ\text{C}/\text{W}$	DC operation Without cooling fins
R_{thJL} Typical Thermal Resistance Junction to Lead	34	$^\circ\text{C}/\text{W}$	DC operation
wt Approximate Weight	1.2(0.042)	g(oz.)	
Case Style	C-16		

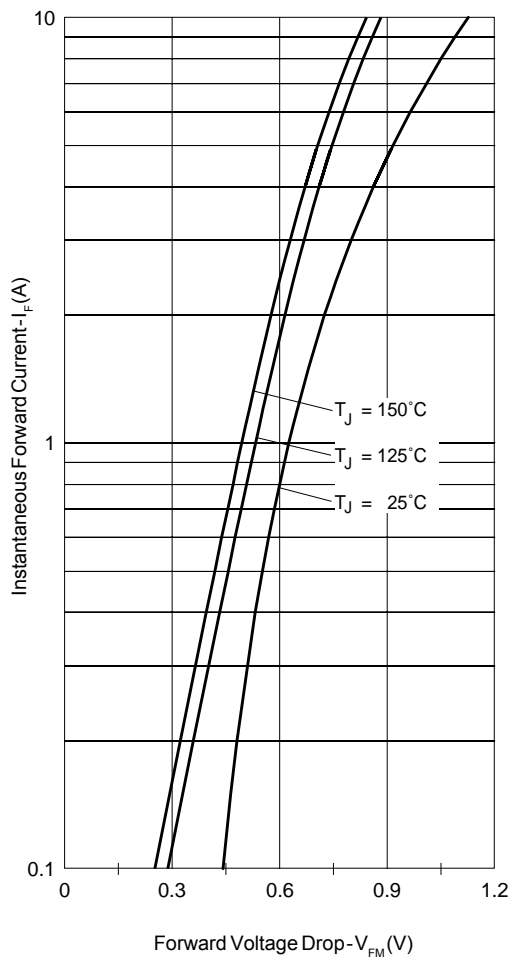

Fig. 1 - Max. Forward Voltage Drop Characteristics

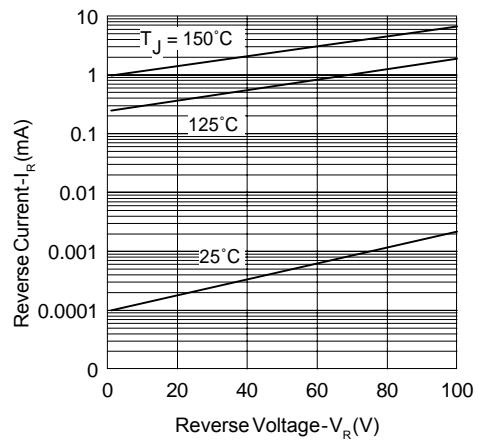

Fig. 2 - Typical Values Of Reverse Current Vs. Reverse Voltage

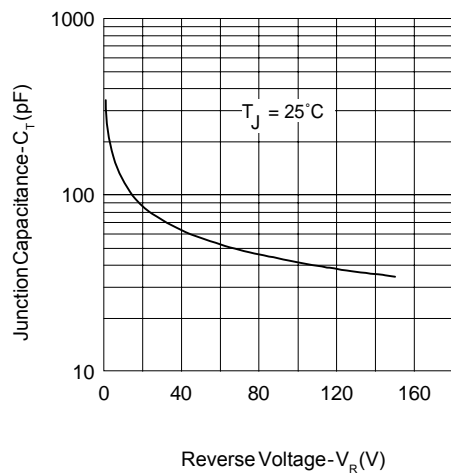

Fig. 3 - Typical Junction Capacitance Vs. Reverse Voltage

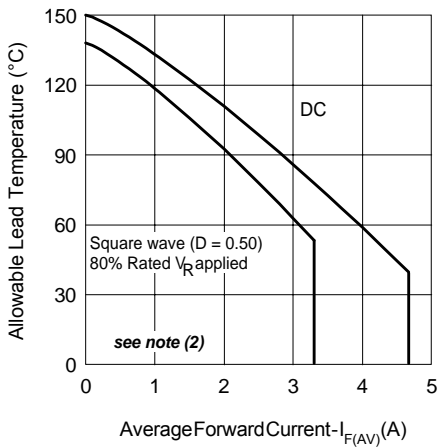

Fig. 4 - Max. Allowable Lead Temperature Vs. Average Forward Current

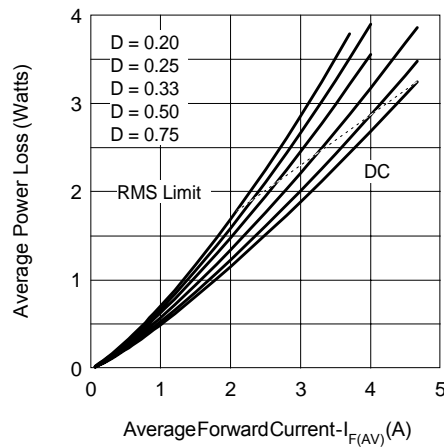

Fig. 5 - Forward Power Loss Characteristics

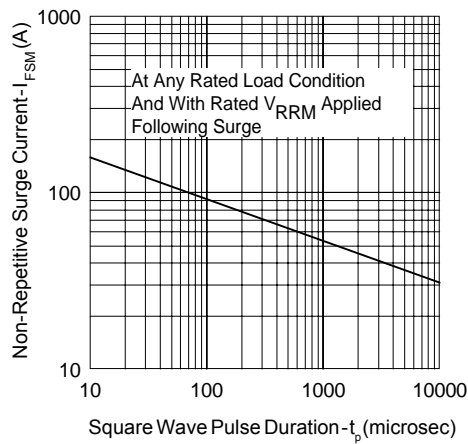

Fig. 6 - Max. Non-Repetitive Surge Current

(2) Formula used: $T_C = T_J - (Pd + Pd_{REV}) \times R_{thJC}$;
 $Pd = \text{Forward Power Loss} = I_{F(AV)} \times V_{FM} @ (I_{F(AV)} / D)$ (see Fig. 6);
 $Pd_{REV} = \text{Inverse Power Loss} = V_{R1} \times I_R (1 - D); I_R @ V_{R1} = 80\% \text{ rated } V_R$

Ordering Information Table

Device Code	
31	D
Q	10
TR	
①	②
③	④
⑤	
1	- 31 = 3.3A (Axial and small packages - Current is x10)
2	- D = DO-41 package
3	- Q = Schottky Q.. Series
4	- 10 = Voltage Ratings
5	- TR = Tape & Reel package (5000 pcs)
	TB = Tape & Box package (Ammunition -3000 pcs)
	- = Box package (1000 pcs)

10 = 100V
 09 = 90V

Data and specifications subject to change without notice.
 This product has been designed and qualified for Industrial Level.
 Qualification Standards can be found on IR's Web site.