



Produktname | *Product name*: WFL800AC
 Artikelnummer | *Part Number*: 1600-0280
 Anfragenummer | *Inquiry Number*: AN-ML-2018-339
 Ersteller / Datum | *Creator / Date*: LHE / 14.01.2019

Version	Änderung / Change	Datum / Date	Name
V0	---	14.01.2019	LHE

Template name: ANSMANN xxxx-xxxx_0DA, Template version: V28

Zeichnung der Leuchte / Drawing of the light

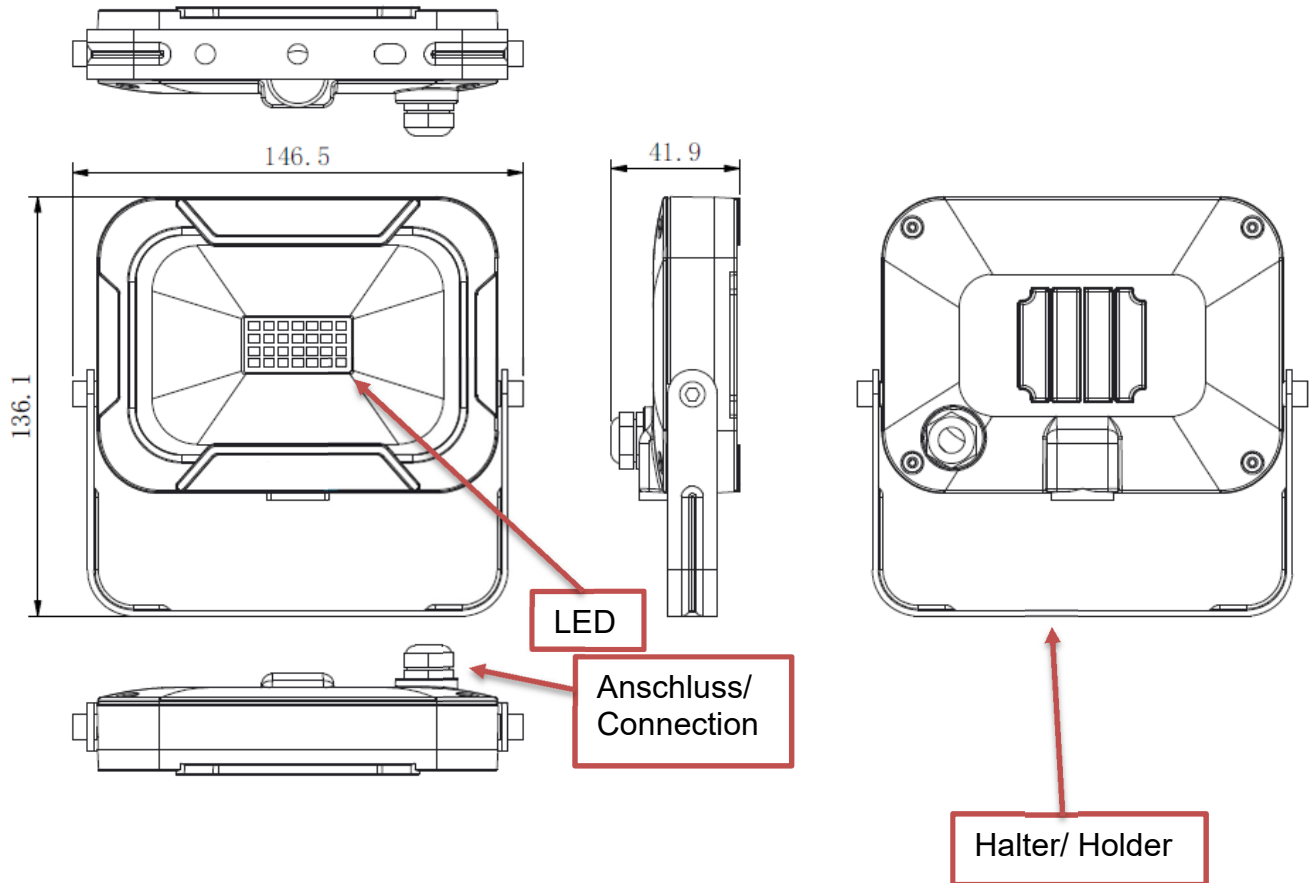

Allowable deviation / general tolerances DIN ISO 2768-c

Technische Daten der Leuchte / Technical data of the light:

Haupt-LED-Leuchtmittel:	28 x 0,5 W LEDs = 10 W	Main LED illuminant:	28 x 0.5 W LEDs = 10 W
Optisches System der Haupt-LED:	(Weitwinkel-ausleuchtung)	Optical system of the main LED:	(wide angle illumination)
CRI der Haupt-LED:	Ra > 80	CRI of the main LED:	Ra > 80
Farbtemperatur (CCT) der Haupt-LED:	5000 K	Colour temperature (CCT) of the main LED:	5000 K
Mindestabstand zu beleuchteten Gegenständen von der Haupt-LED:	0,5 m	Minimum distance from lighted objects from the main LED:	0.5 m
Schalterfunktion:	Kein Schalter	Switch function:	No switch

Lichtstrom: [Lumen]	ca. 800 lm	Luminous flux (light output): [Lumen]	approx. 800 lm
Leuchtdauer:	24 h	Run time:	24 h
Leuchtweite: (ca.)	38 m	Beam distance: (approx.)	38 m
Maximale Lichtstärke: [Candela]	ca. 350 cd	Peak beam / luminous intensity: [Candela]	approx. 350 cd
Maximale Beleuchtungsstärke: [Lux]	ca. 1440 lx (Abstand: 0,5 m)	Peak beam illuminance: [Lux]	approx. 1440 lx (Distance: 0.5 m)

Eingangsverbindung:	AC mit 20cm H05RN-F 3G1.0mm ² Kabel (offen)	Input connection	AC with 20cm H05RN-F 3G1.0mm ² cable (exposed)
Eingangsspannung:	220-240 V	Input voltage	220-240 V
EU-Energieeffizienzklasse:	A+	EU energy efficiency class	A+
Schutzart:	Ip54	Ingress Protection Marking:	Ip54
Schutzklasse:	I	Protection class:	I
Getestete Fallhöhe:	1 m	Tested drop height:	1 m
Stoßfestigkeitsgrad:	IK05	Degree of protection against mechanical impacts:	IK05
Gehäusematerial:	Aluminium	Housing material:	Aluminium
Betriebstemperatur:	-20 °C...50 °C	Operating temperature:	-20 °C...50 °C
Approbationen:	CE	Approvals:	CE
Gewicht:	437 g (Lampe)	Weight:	437 g (lamp)

Größte projizierte Fläche des Strahlergehäuses und seiner externen Teile:	200 cm ²	<i>Maximum projected area of the flood light housing and its external parts:</i>	200 cm ²
Bereich der Montagehöhe:	0,0 m ... max. 3,0 m	<i>Range of mounting heights:</i>	0.0 m ... max. 3 m
Verwendbar in Innenräumen:	Ja	<i>Suitable for use indoors:</i>	Yes

Verwendungszweck:	Baustrahler	<i>Intended purpose:</i>	<i>Flood light</i>
Verwendungseinschränkung:	<ul style="list-style-type: none"> - Nicht zur Verwendung in anderen Anwendungen bestimmt. - Nicht für die Raumbeleuchtung im Haushalt geeignet. 	<i>Restriction of use:</i>	<ul style="list-style-type: none"> - Not intended for use in other applications. - Not suitable for household room illumination.
Für extreme physische Bedingungen geeignet:	Ja	<i>Suitable for extreme physical conditions:</i>	Yes

Allgemeine technische Daten / Common technical data:

Lagertemperatur:	(Device only:) -25 °C...65 °C	<i>Storage temperature:</i>	(Device only:) -25 °C...65 °C
Lieferumfang:	<ul style="list-style-type: none"> - Leuchte - Mehrsprachige Bedienungsanleitung 	<i>Shipment:</i>	<ul style="list-style-type: none"> - Luminary - Multilingual operating instruction
Verpackung:	Farbige Faltschachtel	<i>Package:</i>	Coloured folding box