

# LQH31HZR75K03#

# indicates a package specification code.



< List of part numbers with package codes >  
 LQH31HZR75K03L , LQH31HZR75K03K

## Shape

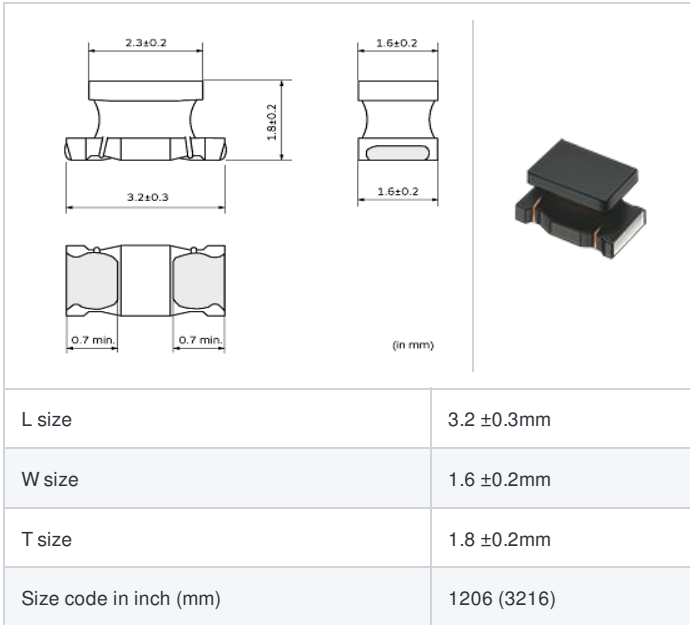

## References

Packaging code	Specifications	Minimum quantity
L	φ180mm Embossed taping	2000
K	φ330mm Embossed taping	7500

Mass (Typ.)	
1 piece	0.029g

## Specifications

Inductance	750nH ±10%
Inductance test frequency	1MHz
Rated current (Itemp) (Based on Temperature rise)	190mA
Max. of DC resistance	1.027Ω
Avg. of DC resistance	0.79Ω ±30%
Q (min.)	60
Q test frequency	100MHz
Self resonance frequency (min.)	220MHz
Operating temperature range (Self-temperature rise is not included)	-40°C to 85°C
Series	LQH31HZ_03

### ⚠ Attention

- 1.This datasheet is downloaded from the website of Murata Manufacturing Co., Ltd. Therefore, it's specifications are subject to change or our products in it may be discontinued without advance notice. Please check with our sales representatives or product engineers before ordering.
- 2.This datasheet has only typical specifications because there is no space for detailed specifications. Therefore, please review our product specifications or consult the approval sheet for product specifications before ordering.

**Chart of characteristic data (The charts below may show another part number which shares its characteristics.)**

▪ Q-Frequency characteristics (Typ.)

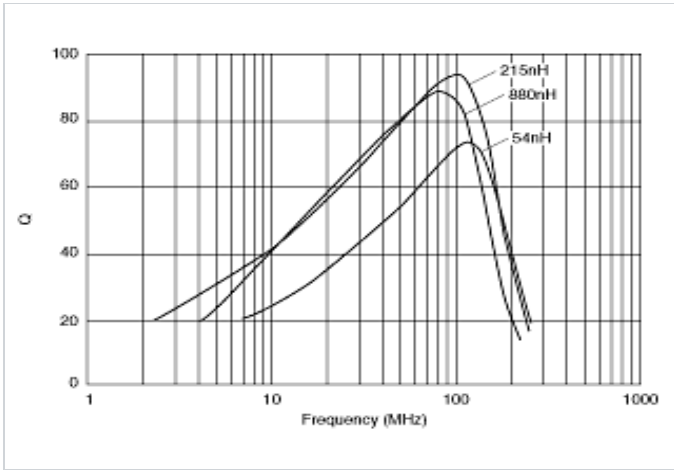

**⚠ Attention**

- 1.This datasheet is downloaded from the website of Murata Manufacturing Co., Ltd. Therefore, it's specifications are subject to change or our products in it may be discontinued without advance notice. Please check with our sales representatives or product engineers before ordering.
- 2.This datasheet has only typical specifications because there is no space for detailed specifications.  
Therefore, please review our product specifications or consult the approval sheet for product specifications before ordering.