

Order Code: 829993STICK

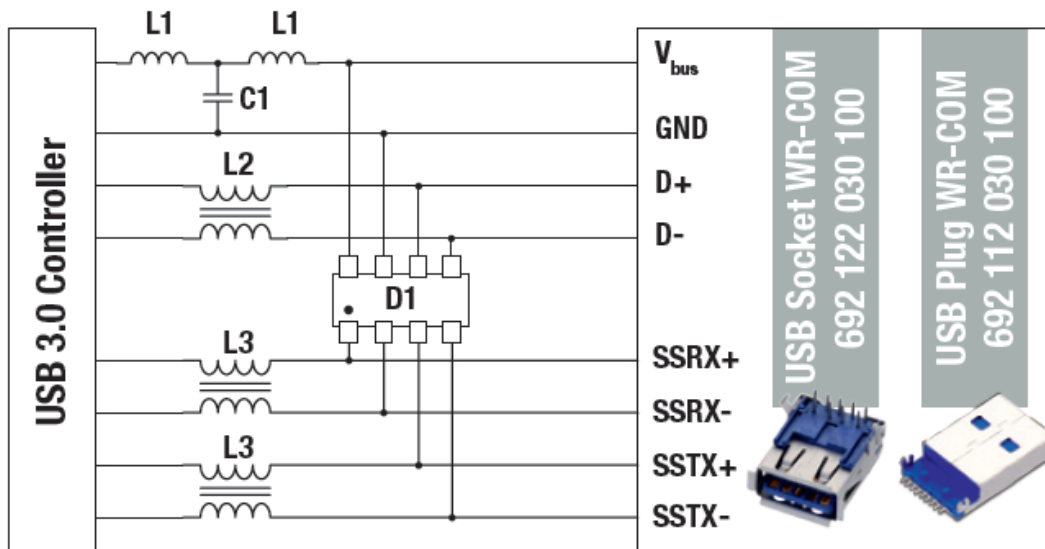

USB 3.0 EMC Stick with integrated ESD Protection and EMI Filter

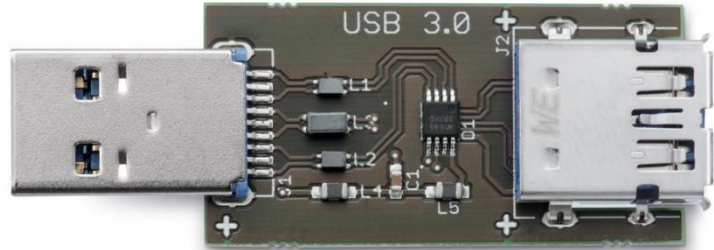

L1 WE-CBF	742 792 040	
	Size: 0805	
	I_R : 2000 mA	
	Z: 600 Ω	

L2 WE-CNSW	744 232 090	
	Size: 1206	
	I_R : 370 mA	
	Z: 90 Ω	

L3 WE-CNSW HF	744 233 670	
	Size: 0805	
	I_R : 320 mA	
	Z: 67 Ω	

D1 WE-TVS	824 016 46	
	Size: MSOP-8L	
	V_{DC} : 5.0 V	
	C_{Ch} : 0,2 pF	

C1 WCAP-CSGP	885 012 206 051	
	Size: 0603	
	C: 680 nF	
	U_R : 16 V	

ONLY FOR DESIGN PURPOSES

Order Code: 829993STICK

Electrical Properties

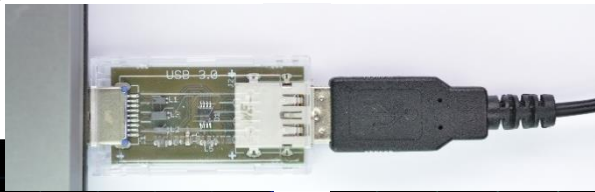
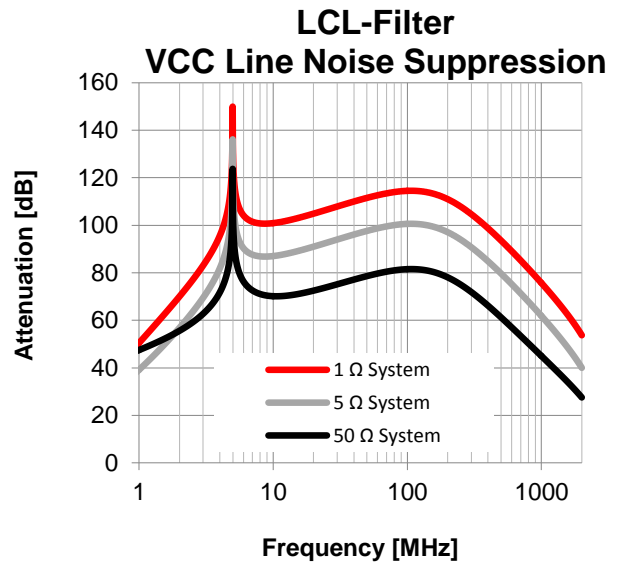
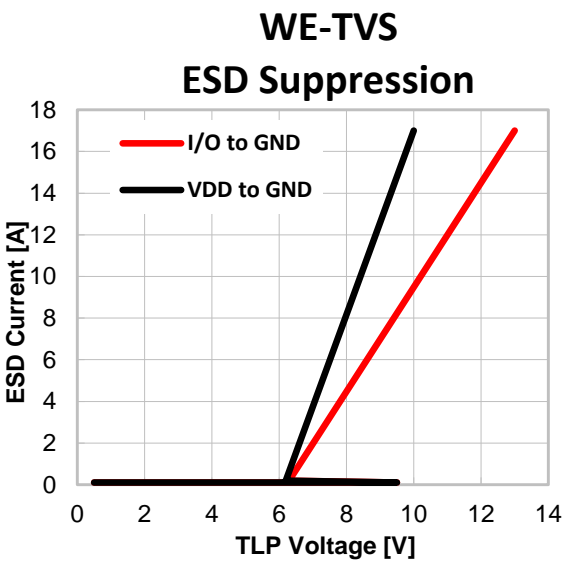
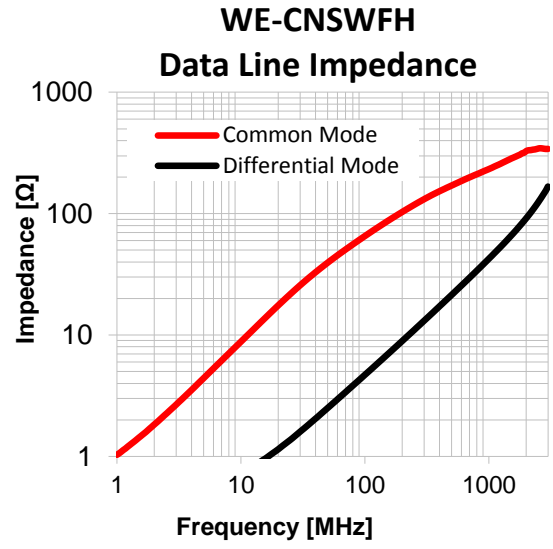
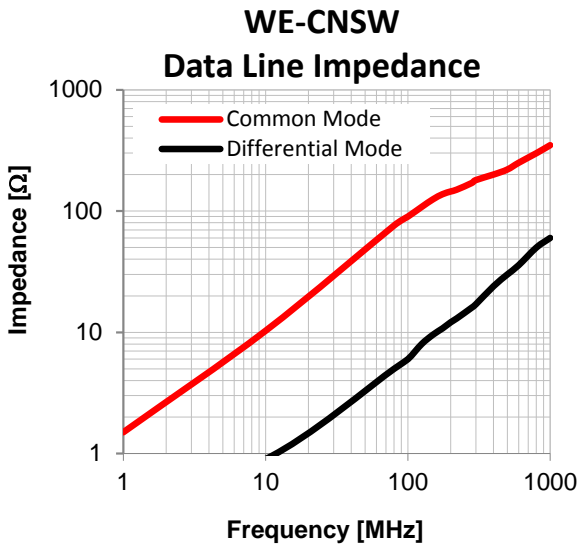

Noise without filter

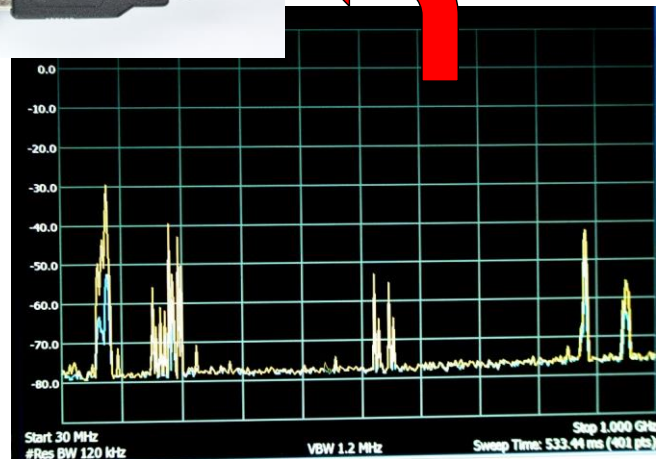

Noise with filter

ONLY FOR DESIGN PURPOSES